

Ray101

Handheld VHF

Marine Radio

Owner's Handbook

Document number: 81229-3
Date: January 2005

Contents

| | |
|---|-----------|
| About this Handbook | 7 |
| Purpose | 7 |
| Conventions Used | 7 |
| Technical Accuracy | 7 |
| Warranty | 7 |
| Important Information | 8 |
| Safety Warnings | 8 |
| EMC Conformance | 9 |
| Raymarine Products and Services | 10 |
| Chapter 1: General Information | 11 |
| 1.1 Introduction | 11 |
| 1.2 Features | 11 |
| 1.3 Licensing Requirements | 12 |
| Chapter 2: Installation | 15 |
| 2.1 Unpacking and Inspection | 15 |
| Equipment Supplied | 15 |
| 2.2 Attaching the Antenna | 15 |
| 2.3 Using the Belt Clip | 16 |
| 2.4 Attaching the Wrist Strap | 16 |
| 2.5 Battery Usage | 16 |
| Battery Tray | 17 |
| Charging Rechargeable Ni-MH Cells | 19 |
| Charger LED | 20 |
| Storage | 21 |
| Chapter 3: Getting Started | 23 |
| 3.1 Keypad and Rotary Knobs | 23 |
| Rotary Keys | 24 |
| Push Keys | 24 |
| Description | 24 |
| 1. PWR/VOL | 24 |
| 2. SQ | 24 |
| 3. PTT | 24 |
| 4. UP/DOWN | 25 |
| 5. Backlight / Keylock | 25 |
| 6. 16/9 | 25 |
| 7. DW/TRI | 25 |
| 8. WX / BAND | 25 |
| 9. SCAN / SAVE | 25 |
| 10. HI/LO / USER | 25 |

| | | |
|-------------------|---|-----------|
| 3.2 | LCD Display | 26 |
| 1. | (TX) Transmitting | 26 |
| 2. | (RX) Receiving | 26 |
| 3. | (USER) Favorite Channel Mode | 26 |
| 4. | (SAVED) Memory Mode | 27 |
| 5. | (P) Priority Mode | 27 |
| 6. | (SCAN) All Scan/Saved Scan/Priority Scan | 27 |
| 7. | (U I C) Channel Set | 27 |
| 8. | (B) Receive-only Channel | 27 |
| 9. | (A) Simplex Channel | 27 |
| 10. | Channel Number | 27 |
| 11. | Battery Level | 27 |
| 12. | Keylock | 28 |
| 13. | Indicators | 28 |
| 14. | Signal Strength | 28 |
| Chapter 4: | Operating the Radio | 29 |
| 4.1 | Turning the Power ON and OFF | 29 |
| 4.2 | Setting the Volume | 29 |
| 4.3 | Setting the Squelch | 30 |
| 4.4 | Setting the Power Output | 30 |
| | Overriding the Low Output Power Restriction (US only) | 31 |
| 4.5 | Setting the Channel | 31 |
| 4.6 | Selecting a Weather Channel | 31 |
| | Weather Alert Operation | 32 |
| 4.7 | Setting the Frequency Band | 33 |
| 4.8 | Selecting Priority Mode | 33 |
| 4.9 | Selecting the Secondary Priority Channel | 34 |
| | Reprogramming the Secondary Priority Channel | 34 |
| 4.10 | Transmitting | 35 |
| 4.11 | Turning On the Backlight | 36 |
| 4.12 | Turning On the Keylock | 36 |
| 4.13 | Using the Scan Modes | 37 |
| | All Scan | 37 |
| | Saved (Memory) Scan | 38 |
| | Priority All Scan | 39 |
| | Priority Saved Scan | 40 |
| 4.14 | Adding Channels to Memory | 40 |
| 4.15 | Using the Monitor Modes | 42 |
| | Dual Watch | 42 |
| | Tri Watch | 43 |

| | | |
|--------------------|---|-----------|
| 4.16 | USER Channel Mode | 44 |
| 4.17 | Resetting Factory Defaults | 45 |
| Chapter 5: | Customer Service | 47 |
| 5.1 | How to Contact Raymarine | 47 |
| | On the Internet | 47 |
| | Customer Support | 47 |
| | Accessories and Parts | 47 |
| | Technical Support | 48 |
| | Product Repair and Service | 48 |
| Appendix A: | Specifications | 49 |
| Appendix B: | Channel List | 51 |
| | U.S. VHF Marine Radio Channels and Frequencies | 51 |
| | Canadian VHF Marine Radio Channels and Frequencies | 54 |
| | International VHF Marine Radio Channels & Frequencies | 59 |
| | WX Channels (North America only) | 62 |
| Appendix C: | Glossary | 63 |
| | Index | 65 |

About this Handbook

Purpose

This handbook describes the Ray101 portable VHF marine radio. The Ray101 provides communications on all US, Canadian and International marine channels and receives ten weather channels.

Conventions Used

Throughout this handbook, the dedicated (labelled) keys are shown in bold capitals (for example: **SCAN/SAVE**). The LCD indicators and functions are shown in normal capitals (for example: TX).

- Operating procedures, which may consist of a single key-press or a sequence of numbered steps, are indicated by an arrow icon shown in the margin.

Technical Accuracy

To the best of our knowledge, the information in this handbook was correct as it went to press. However, our policy of continuous product improvement and updating may change specifications without prior notice. As a result, unavoidable differences between the product and handbook may occur from time to time. Raymarine cannot accept liability for any inaccuracies or omissions it may contain.

For the latest product information visit our website:

www.raymarine.com

Warranty

To register your new Raymarine product, please take a few minutes to fill out the warranty registration card found at the end of this handbook. It is very important that you complete the owner information and return the card to the factory in order to receive full warranty benefits.

Important Information

Safety Warnings

CAUTION: Navigation Aid

This unit is only an aid to navigation. Its accuracy can be affected by many factors, including equipment failure or defects, environmental conditions, and improper handling or use. It is the user's responsibility to exercise common prudence and navigational judgments. This radio should not be relied upon as a substitute for such prudence and judgment.



CAUTION: Battery and Charger Use

- The battery charger is intended for use in 12 VDC systems only.
- Charge the batteries with the radio powered off for at least 24 hours before using the radio for the first time or if the radio has not been used in several months.
- Do not operate the radio in the charger when the battery tray is empty as this may damage the radio.
- Do not transmit with the radio in the charger.
- Do not short terminals in charger base.
- Do not place charger in water.
- Do not use charger if power plug or cable is damaged.
- Do not charge batteries with + and – terminals reversed.
- Do not recharge batteries if physically deformed or leaking.
- Do not charge anything other than AA-size Ni-MH cells in charger.
- Do not mix Alkaline and Ni-MH cells.
- Do not solder cells directly into battery tray.
- Do not dispose of cells in fire.
- Do not dismantle cells.
- Replace all cells at the same time.
- Store cells in a cool, dry place.
- Charge and discharge under ambient temperature mentioned in cell's specifications.
- Using batteries in extreme conditions (extreme temperature, deep cycle, extreme overcharge and over discharge, etc.) may affect their service life.

**WARNING: Alkaline Battery Use**

When Alkaline cells are used, do not place radio in Charger unless Charge Switch on radio is set to ALKALINE. Charging Alkaline cells may cause excessive heat and could result in cell leakage causing damage or injury.

Ni-MH Battery Recycling



This product is powered by rechargeable Nickel Metal Hydride (Ni-MH) batteries. Ni-MH batteries contain chemically active materials that are hazardous to the environment. When Ni-MH batteries can no longer hold a charge, they should be disposed of properly.

The Rechargeable Battery Recycling Corporation (RBRC) has been established to provide a rechargeable battery recycling program. Spent Ni-MH batteries can be forwarded to a facility that uses a thermal recovery process to reclaim the heavy metals. Collecting and recycling Ni-MH batteries preserves valuable resources and prevents heavy metals from entering the waste system, landfills and incinerators.

When the useful life of your Ni-MH cells has expired, please return them to a recycling center. To find the location of the recycling center nearest you, phone the RBRC at 1-800-822-8837 or point your web browser to:

www.rbrc.com

EMC Conformance

All Raymarine equipment and accessories are designed to the best industry standards for use in the recreational marine environment. Their design and manufacture conform to the appropriate Electromagnetic Compatibility (EMC) standards but correct installation and use is required to ensure that performance is not compromised.

Raymarine Products and Services

Raymarine products are supported by a network of Authorized Service Representatives. Raymarine's Technical Services representatives or your local dealer will be available to answer any questions you may have. For information on Raymarine products and services, contact either of the following:

United States Raymarine, Inc.
22 Cotton Road, Unit D
Nashua, New Hampshire
03063-4219 USA
Telephone: 1-603-881-5200
1-800-539-5539
Fax: 1-603-864-4756

Europe Raymarine UK Ltd
Quay Point
Portsmouth, Hampshire
PO6 3TD United Kingdom
Telephone: +44 (0) 23 9269 3611
Fax: +44 (0) 23 9269 4642

Or, you may contact us on the World Wide Web at:

www.raymarine.com

Raymarine is a registered trademark of Raymarine UK Limited.

Chapter 1: General Information

1.1 Introduction

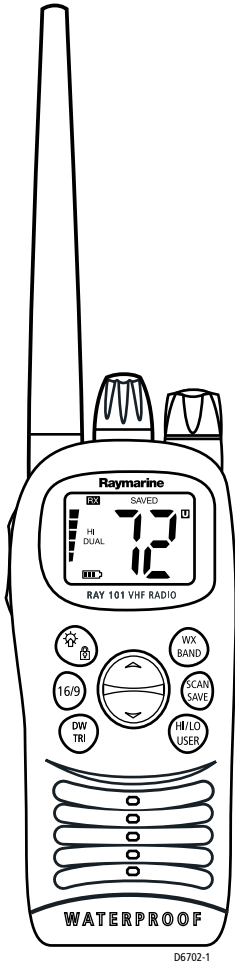

The Ray101 is a microprocessor-controlled, portable transceiver that provides reliable simplex (single frequency) and semi-duplex (two frequency) communications. This handbook describes the physical and functional characteristics of the radio.

The Ray101 provides communications on all US, Canadian and International marine channels and receives ten weather channels. Refer to the Frequency Tables in Appendix B, which list all marine VHF channels available in the radio. You should familiarize yourself with these tables as you are responsible for using the proper channels.

1.2 Features

The Ray101 is designed and manufactured to provide ease of operation with excellent reliability. The Ray101 features:

- Waterproof construction to IPX-7 standard
- Saved-channels Scan and Priority Scan
- Dual/Tri Watch Monitor Modes
- Dedicated Priority Mode Key
- Programmable Secondary Priority Channel key
- 10 Weather Channels
- Ni-MH Batteries, AA-size (included)
- Ni-MH Quick Charger (included)
- 12VDC Cigarette Lighter Adapter (included)

1.3 Licensing Requirements

Raymarine radios comply with the Federal Communications Commission (FCC) and Industry Canada requirements that regulate marine VHF radio usage for the US and Canada, respectively.

This information was current at the time this handbook was printed. Up-to-date information, including licensing requirements, can be obtained on the FCC website at:

www.fcc.gov/wtb/marine

Official FCC forms can be obtained on the FCC website at:

www.fcc.gov/formpage.html

FCC Notice

This device complies with Parts 15 and 80 of the FCC Rules. Operation is subject to the conditions that this device does not cause harmful interference. Changes or modifications to this equipment not expressly approved in writing by Raymarine, Incorporated could violate compliance with FCC rules and void the operator's authority to operate the equipment.

Station License

An FCC Ship Radio Station License and Call Sign are not required for most recreational vessels travelling in US waters.

Operator License

An Operator License is not required to operate a VHF Marine Radio within US territorial waters.

INDUSTRY CANADA

You do not need a license to operate this radio within sovereign waters of Canada or the US. To obtain Industry Canada licensing information for operating this radio outside of Canada or the US, contact the nearest field or regional office, or write:

Industry Canada
Radio Regulatory Branch
Attention: DOSP
300 Slater Street
Ottawa, Ontario
Canada, K1A 0C8

The following information about the radio is required to complete the license application:

Industry Canada Certification Number IC: 4069A-RAY101

FCC Type Number PJ5RAY101

FCC Type Accepted Parts 15 and 80

Output Power 1 watt (low) & 5 watts (high)

Modulation 16FE (FM)

Frequency Range 156.025-157.425

Chapter 2: Installation

2.1 Unpacking and Inspection

Use care when unpacking the unit from the shipping carton to prevent damage to the contents. It is also good practice to save the carton and the interior packing material in the event you must return the unit to the factory.

Equipment Supplied

The following is a list of materials supplied with the Ray101:

Table 2-1: Supplied Components

| Part Number | Description |
|-------------|--|
| E43026 | RAY101 Handheld VHF Radio |
| R49086 | Antenna |
| R49088 | Battery Tray |
| R49089 | Ni-MH Quick Charger Base |
| R49090 | 110VAC Power Adapter for Charger |
| R49092 | 12VDC Cigarette Lighter Adapter ¹ |
| R49097 | Belt Clip |
| R49098 | Wrist Strap |
| 81229 | Ray101 Handbook |
| — | Batteries, (6) AA Ni-MH (1300mAh) |

¹ Connect Cigarette Lighter Adapter to 12VDC system only. Connecting to other voltage systems can damage the charger.

2.2 Attaching the Antenna

Rotate the antenna clockwise to securely fasten it to the threaded connector on the top of the radio.

Note: *Do not operate the radio or press PTT without an antenna attached.*

2.3 Using the Belt Clip

► **To attach the radio to the belt clip:**

Slip the Ray101 onto the belt clip so that the adapter button on the rear of the radio locks into the bottom of the slot on the belt clip.

► **To remove the radio from the belt clip:**

Rotate the radio 180° and pull up and away from the belt clip.

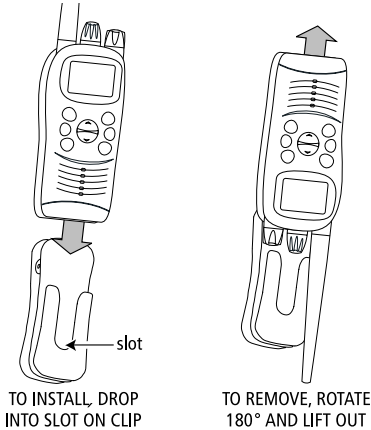

2.4 Attaching the Wrist Strap

1. Using the end of a paper clip, feed the narrow end of the strap through the two mounting holes at the top of the radio behind the antenna.
2. Continue feeding the strap through the loop and pull tight.

2.5 Battery Usage

The Ray101 can be powered by the supplied six (6) Nickel Metal Hydride (Ni-MH) batteries or with six (6) regular AA alkaline cells (not supplied), using the supplied Battery Tray.

Battery Tray

- To open the Battery Tray and insert the battery cells:
1. Lift the fastener at the base of the unit and rotate counterclockwise $\frac{1}{4}$ turn to the UNLOCK position.
 2. While holding the Ray101 in one hand, use the other hand to push the battery tray downward and then away to separate it from the back of the radio.

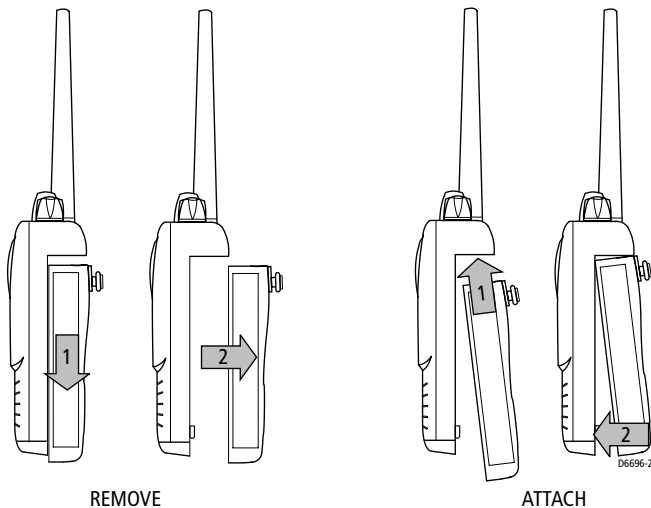

3. Lift up the tab located on the center right side of the battery tray cover and remove it from the battery tray.
4. Locate the Battery Type switch just below the battery compartment and turn to the appropriate position: ALKALINE or Ni-MH.

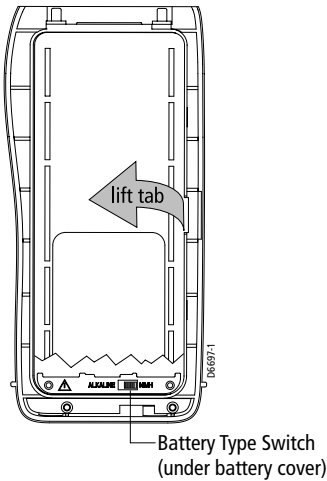

5. Noting the proper orientation, install the AA cells in three rows of two batteries each.
6. Replace the battery tray cover.



WARNING: Alkaline Battery Use

When Alkaline cells are used, do not place radio in Charger unless Charge Switch on radio is set to ALKALINE. Charging Alkaline cells may cause excessive heat and could result in cell leakage causing damage or injury.

7. Slide the battery tray up into the rear of the radio and then downward until it snaps into place.
8. Rotate the fastener at the base of the battery case clockwise $\frac{1}{4}$ turn to the LOCK position.

Note: *The battery charger is intended for use in 12 VDC systems only.*

Charging Rechargeable Ni-MH Cells

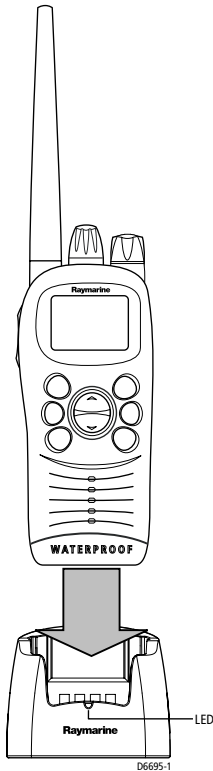

The Ni-MH batteries must be charged with the radio powered off for at least 24 hours before initial use. To charge the batteries:

1. Insert the radio with the battery tray attached into the Ni-MH charger unit.
2. Connect the AC wall adapter into a standard wall outlet.

—or—

Connect the Cigarette Lighter Adapter into a standard 12VDC Cigarette Lighter.

3. Insert the molded plug into the connector on the side of the battery charger.

The CHARGE indicator LED on the front of the charger lights when it is receiving voltage from the AC adapter.

CAUTION:

1. Make sure the switch just below the battery compartment is set to the Ni-MH position.
2. Do not operate radio in charger when battery tray is empty. This may damage radio.
3. Do not transmit with the radio in the charger as this may damage the radio.

Charge the batteries with the radio powered off for at least 24 hours before using the radio for the first time or if the radio has not been used in several months.

Under normal use, you can charge the batteries while the radio is powered on. With heavy usage, however, the radio should be powered off to maximize charging efficiency. Normal use is defined as a duty cycle of 5% receive and 95% standby time.

Charger LED

The following describes status of the charger's LED when it is receiving voltage from the adapter:

| LED Color | Status |
|-------------------------------|--|
| RED | <ul style="list-style-type: none"> Batteries are charging (fast charge) |
| AMBER/ ORANGE ¹ | <ul style="list-style-type: none"> Input power is too low and the charger has turned off, or Input power is too high and the charger has turned off. |
| GREEN ² | <ul style="list-style-type: none"> Batteries are fully charged and the charger is maintaining a trickle charge, or Battery tray is empty and unit is not charging, or Battery Type Switch is set to ALKALINE and unit is not charging, or Charger is in Standby Mode and is not charging |

¹ If the charger LED turns AMBER/ORANGE, you should disconnect the charger and investigate the reason for the overvoltage or undervoltage condition.

² To protect the batteries, the charger remains in Standby Mode (not charging) if the batteries are too cold or too hot (hot to the touch). During this time, the unit does not charge and the LED remains green.

Before initial use, apply power to the charger with the radio removed. Check the status of the charger's LED before inserting the radio:

- If the LED is green, the input voltage is OK. Insert the radio into the charger. The LED should turn red, indicating that the batteries are being charged.
- If the LED is amber/orange, there is an undervoltage or overvoltage condition in the boat's power system. Disconnect the charger and investigate the reason for the power problem before inserting the radio.

During initial charging or if charging when the radio has not been used in several months, the LED may turn green prematurely (before the batteries are fully recharged). Continue to charge the batteries for a full 24 hours even if the LED turns green before this 24 hour period has expired.

If you suspect that the LED may have turned green prematurely, you can perform a test by powering on the radio, switching to high power and holding the PTT switch for 1 second. If the Battery Level indicator loses segments in the bar graph, the batteries are not fully charged.

After the initial charge, it takes about 2 hours to recharge spent batteries and for the LED to turn green.

Note: *Purchase an additional battery tray and extra batteries so that you will always have spare charged batteries available.*

Storage

It is normal for any battery cell to lose charge even when it is not being used. Before storing the radio for 6 months or more:

- Fully charge the batteries to help ensure that the cells do not experience a deep discharge while they are in storage.
- Remove the Battery Tray from the radio and then remove the batteries from the Battery Tray to help prevent internal current leakage that can result in corrosion.
- Store the batteries in a cool, dry place to further minimize current leakage.

After storage, multiple charge/recharge cycles may be required before maximum capacity is restored.

Chapter 3: Getting Started

3.1 Keypad and Rotary Knobs

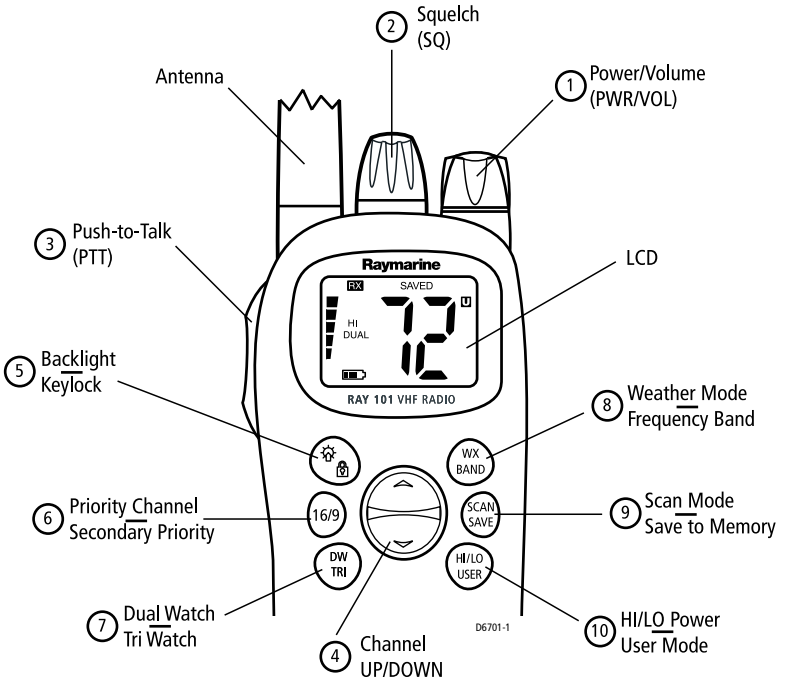

Several of the keys on the front panel of the base station serve multiple purposes. For the most part, the function indicated on the first line of the key is accessed by pressing and releasing that key. The function indicated on the second line of the key is accessed by pressing and holding the key for three seconds.



Rotary Keys

| Key Name | Function |
|------------|--|
| 1. PWR/VOL | Power radio ON / OFF and adjust volume level |
| 2. SQ | Adjust squelch threshold level |

Push Keys

| Key Name | Press & Release (<3 sec) | Press & Hold (>3 sec) |
|--|--|--|
| 3. PTT | Push to talk | Push to talk |
| 4. UP/DOWN | Channel increment / decrement | Rapid channel change |
| 5.   | Backlight ON/OFF | Keylock ON/OFF |
| 6. 16/9 | Switches between Priority and Working Channels | Switches to secondary Priority CH (9); If already tuned to secondary channel, programs a new secondary Priority Channel. |
| 7. DW / TRI | Dual Watch Mode | Tri Watch Mode |
| 8. WX / BAND | Weather Channel Mode | Select frequency band |
| 9. SCAN / SAVE | Scan ON/OFF | SAVE/DELETE channel to/from memory |
| 10. HI/LO / USER | TX Power High/Low | USER (Saved Memory Channel) Mode |

Description



1. PWR/VOL

Use this knob to turn the radio ON and OFF and to set the volume.



2. SQ

Use this knob to set the squelch threshold, which cuts off the receiver when the signal is too weak for reception of anything but noise.



3. PTT

While pressing this Push-To-Talk key radio transmission is enabled.



4. UP/DOWN

Use the arrow keys to change the current channel number. Press and hold for rapid channel changing.



5. Backlight / Keylock

Press and release this key to toggle on and off the display's backlight. Press and hold to toggle the keylock function, which protects the radio from any keypad entry.



6. 16/9

Press and release this key to toggle on and off Priority Mode, in which the radio switches to Priority Channel 16 at high power. Press and hold to switch to the Secondary Priority Channel. If already in Priority Mode, press and hold to change the Secondary Priority Channel.



7. DW/TRI

Press and release this key to toggle on and off Dual Watch, in which the radio monitors the current working channel and CH 16 in cycle. Press and hold to toggle on and off Tri Watch, which monitors CH 16, the current working channel and the channel you have set as the Secondary Priority Channel in cycle.



8. WX / BAND

Press and release this key to toggle on and off Weather Channel mode. Press and hold this key to alternate the frequency band between the USA, International and Canadian channel sets.



9. SCAN / SAVE

Press and release this key to toggle on and off Scan Mode. Press and hold to save a channel into the radio's memory.



10. HI/LO / USER

Press and release this key to toggle the transmit power between HIGH and LOW. Press and hold to enter User Channel Mode, which displays only the channels that you have saved to memory.

3.2 LCD Display

The following describes the functional characters on the Ray101’s LCD.

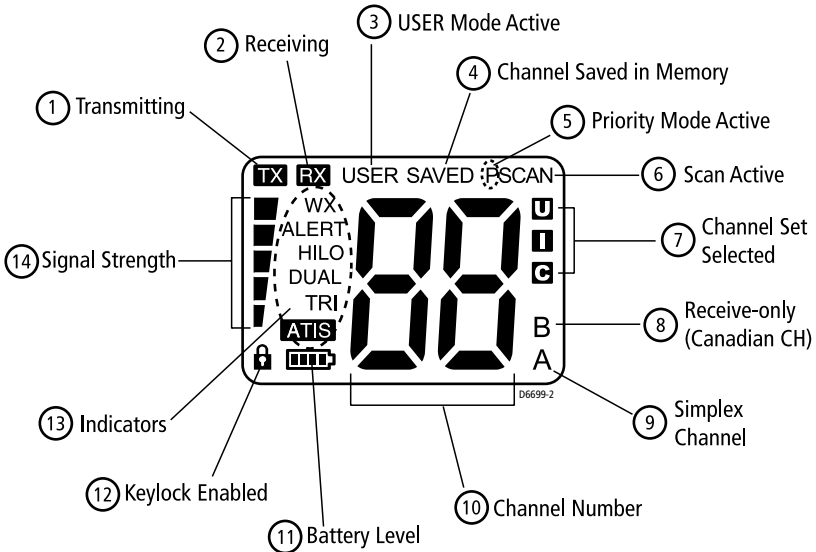

1. (TX) Transmitting

Indicates the PTT is being pressed and the radio is transmitting.

2. (RX) Receiving

Indicates that the radio is receiving a radio signal. If the radio receives a signal but the squelch threshold is set so high that the signal cannot be heard, the RX indicator is not displayed but the bar graph on the left side of the LCD is illuminated to show the appropriate signal strength.

3. (USER) Favorite Channel Mode

Indicates the radio is in USER Mode. USER Mode displays only the channels that you have saved to memory, enabling you to easily scan your favorite channels while bypassing unwanted or seldom-used channels.

4. (SAVED) Memory Mode

Indicates the current channel has been saved in memory. Appears during Saved Scan mode. Only saved channels are scanned during USER mode.

5. (P) Priority Mode

P appears during Priority Mode, when the **16/9** key is pressed. Also appears with PSCAN during Priority Scan mode.

6. (SCAN) All Scan/Saved Scan/Priority Scan

SCAN appears during All Scan and Saved Scan. (SAVED also appears during Saved Scan mode.) PSCAN appears during Priority Scan mode.

7. (U I C) Channel Set

Indicates which channel group set is currently selected: **US**, International or Canadian.

8. (B) Receive-only Channel

Indicates that you cannot transmit on the currently-selected channel; it is receive-only. Used with Canadian channels only.

9. (A) Simplex Channel

Indicates that the currently-selected channel is simplex in US and Canadian channels but duplex in the International channel set. Simplex means you transmit and receive on the same frequency. Used with US and Canadian channels only.

10. Channel Number

Displays the current channel number.

11. Battery Level

Indicates current battery strength. Greater battery strength displays a larger number of segments in the bar graph.

 Fully charged

 Normal operation

 Normal operation

 Needs charging

12. Keylock

Indicates the radio is protected from any keypad entry except for PTT and the backlight function.

13. Indicators

Indicates special conditions:

(WX) Weather Channel

Weather channel mode is active. US and Canada only.

(ALERT) Weather Alert

A weather alert is being received. US and Canada only.

(HI/LO) TX Power

Indicates whether transmit power is set for 5 watts (HI) or 1 watt (LO).

(DUAL) Dual Watch

Indicates the radio is in Dual Watch mode.

(TRI) Tri Watch

Indicates the radio is in Tri Watch mode.

(ATIS) ATIS Active

Indicates that Automatic Transmitter Identification System (ATIS) transmission is enabled. For use on the inland waterways of certain European countries only.

14. Signal Strength



Displays the relative strength of the TX and RX signals.

When the output power is set for 5 watts, the full scale (5 bars) is displayed during transmission.

When transmit output power is set for 1 watt, only two bars are displayed during transmission.

When receiving, the bar graph indicates the strength of the signal being received. A stronger signal displays a larger number of segments in the bar graph.

Chapter 4: Operating the Radio

4.1 Turning the Power ON and OFF

Turn the **PWR/VOL** knob clockwise until it clicks.
When the unit powers up in Normal mode it:

1. Beeps, illuminates the backlight at full brightness, and displays all segments and indicators for 2 seconds.
2. Displays the software version number on the LCD but without the decimal point. For example, version 4.2 would appear as 42.
3. Recalls the last CH number, TX power settings and operation mode. If no last-used setting data exists, goes to CH 16 and high TX Power.

► To turn the unit OFF:

Rotate the Volume knob completely counterclockwise until it clicks.

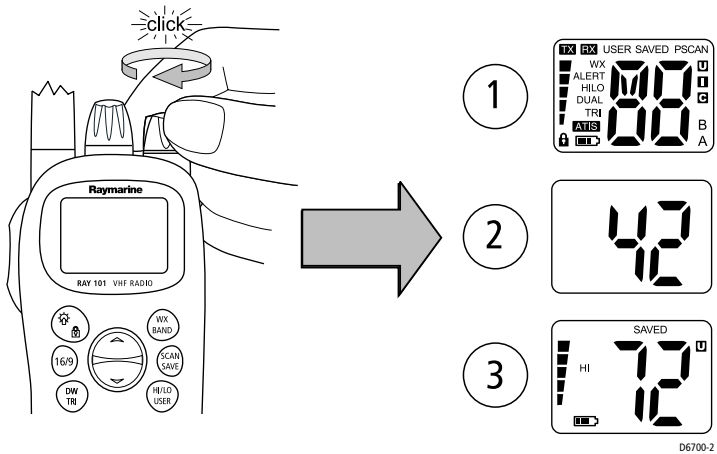

4.2 Setting the Volume

Adjust the **PWR/VOL** knob to control the loudspeaker volume level. Turn clockwise to increase the volume; counterclockwise to decrease the volume.

Note: Key press beep volume is also controlled by the VOL level.

4.3 Setting the Squelch

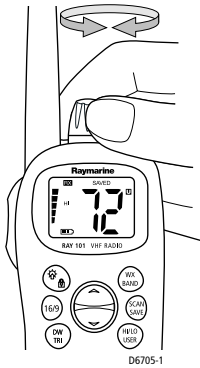

The Squelch circuit sets the threshold for cutting off the receiver when the signal is too weak for reception of anything but noise.

To properly set the squelch, rotate the **SQ** knob counterclockwise until noise is heard.

Then rotate clockwise until background noise disappears.

4.4 Setting the Power Output



Press and release the **HI/LO / USER** key to toggle the TX power from LOW (1 watt) to HIGH (5 watts). The corresponding LO or HI indicator appears on the LCD.

Initial contact should always be attempted using low power. You should switch to high power only when contact can not be made on low power in emergency situations. This procedure is specified by the FCC but is also part of marine communications courtesy and will save on battery life.

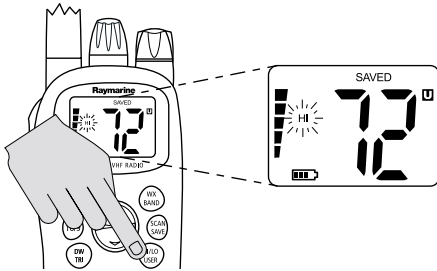

Press and release

Note: Some channels are limited by regulation to be low power only. If the HI/LO operation request is denied, an error tone beeps.

Overriding the Low Output Power Restriction (US only)

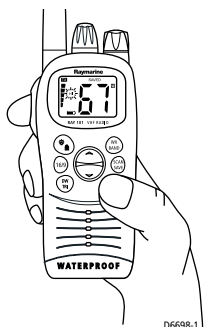

The low power requirement on channels 13 and 67 in US mode can be temporarily overridden in cases where 1W is not sufficient.

- To override the LO power restriction on channels 13 or 67 and transmit at high power:

Press and hold the **PTT** key. TX power is LO. Press and hold the **HI/LO / USER** key while continuing to hold **PTT**. Output is set to HI power for as long as you hold down the **HI/LO / USER** key.

Note: Channels 13 and 67 are for bridge to bridge operations only. See Appendix B: Channel List for approved usage.

4.5 Setting the Channel

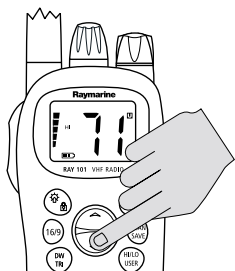

Press and release the UP arrow to increment the channel number.

Press and release the DOWN arrow to decrement the channel.

Press and hold either key for rapid channel scrolling.

4.6 Selecting a Weather Channel



The US National Oceanic and Atmospheric Administration (NOAA) broadcasts continuous weather reports and severe weather alerts, as needed. The Ray101 is programmed to receive 10 NOAA weather channels and sound an alarm if a weather alert is received.

Press and release the **WX/BAND** key to enter Weather mode. The WX indicator appears.

Press Channel UP/DOWN to change the WX channel 1 through channel 10.

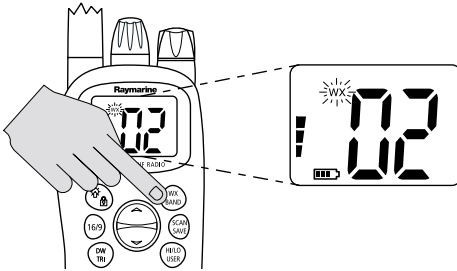

Press and release

Press and release the **WX/BAND** key again to return to normal operation.

Note:

1. *Weather broadcasts can only be heard in the North America.*
2. *During Weather mode, the PTT, SCAN/SAVE and HI/LO / USER keys are disabled and an error beep sounds if pressed.*

Weather Alert Operation

Weather Alert is toggled ON and OFF by pressing and holding **WX/BAND** key in the weather mode. The ALERT icon illuminates.

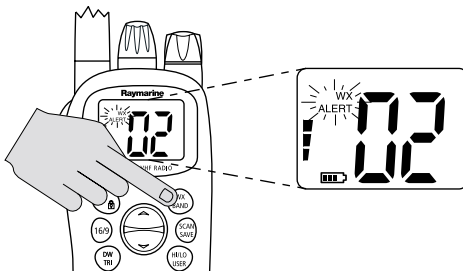

Press and hold

When Weather Alert function is enabled and the radio is tuned to the normal working channel, the last-used weather channel is checked every 30 seconds for weather alert tone. If the alert tone is detected, the WX and ALERT indicators flash and a short alarm tone sounds.

The radio automatically turns to the currently-monitored WX channel where the weather alert has been detected. The alert is detected in all modes of operation (Standby, Dual and Tri Watch, Scan, etc.)

4.7 Setting the Frequency Band



The Ray101 can transmit and receive on all available US, Canadian and International marine VHF radiotelephone channels.

Press and hold the **WX/BAND** key for greater than 3 seconds while in normal operation mode to alternate between the International, US and Canadian channel sets. The appropriate indicator is illuminated in the LCD: U for US, I for International, or C for Canadian channel sets.

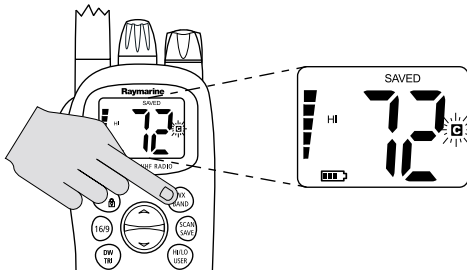

Press and hold

Note: *Pressing and holding the WX/BAND key for greater than 3 seconds while in Weather mode toggles the Weather Alert mode.*

4.8 Selecting Priority Mode



The Ray101 provides you with a dedicated key for selecting Priority Mode, which instantly switches the radio to Priority Channel 16 at high power.

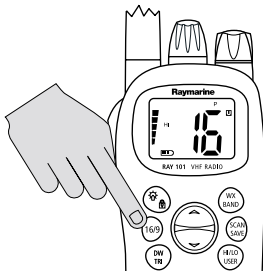

Press and release

If not already tuned to the Priority Channel 16, press and release the **16/9** key to place the radio into Priority Mode. While in this mode, the radio is switched to CH16 at high power. The P and HI indicators appear on the LCD.

Note: *When you press the 16/9 key, the radio always switches to HIGH power. You can use the HI/LO / USER key to change to LOW power.*

The following describes the results of pressing the various keys during Priority Mode:

- **16/9** Press and release to return to the last-used working channel. Press and hold to switch to the Secondary Priority Channel.

- **WX / BAND.** Press and release to switch to Weather Mode. Press and hold to switch to the other channel sets. The radio remains in Priority Mode even though it switches frequency sets.
- **SCAN / SAVE.** Press and release to initiate Scan Mode. When you press again, the scan halts and the radio returns to Priority Mode. Press and hold to save CH16 into memory but remain in Priority Mode.
- **HI/LO / USER.** Press and release to reduce to low power but remain in Priority Mode. Press and hold to enter User Mode. The radio switches to the last-used User Mode channel but exits Priority Mode.
- **DW / TRI.** This key is not available during Priority Mode and an error tone sounds if pressed.

4.9 Selecting the Secondary Priority Channel

16/9

The Ray101 enables you to program the **16/9** key to switch to a Secondary Priority Channel. The default is CH 9.

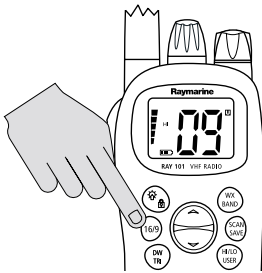

Press and hold

If on a working channel, press and hold the **16/9** key for greater than 3 seconds to switch to the Secondary Priority Channel at high power. The default is CH 9.

If on primary Priority CH16, press and hold the **16/9** key for greater 3 seconds to switch to the Secondary Priority Channel at HI power. The default is CH 9. If already on Secondary Priority Channel, press and release the **16/9** key to switch to Priority Channel 16 at high power.

Reprogramming the Secondary Priority Channel

1. Switch to the Secondary Priority Channel.
2. Press and hold the **16/9** key for greater 3 seconds to switch to Reprogram mode. An alert tone sounds and the current Secondary Priority Channel flashes.
3. Change the channel number with the UP and DOWN arrow keys.
4. Press and release the **16/9** key to save the new Secondary Priority selection. An alert tone sounds to indicate that the Secondary Priority has been changed.

Note: While reprogramming the Secondary Priority Channel, the PTT, DW/TRI and WX/BAND keys are disabled and an error beep sounds.

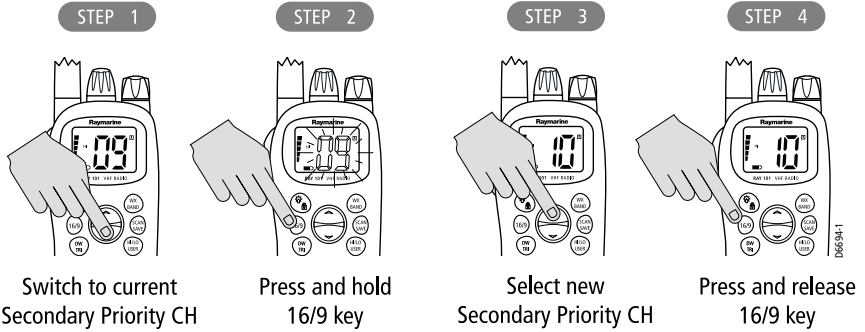

4.10 Transmitting



Press and hold the Push-To-Talk (**PTT**) key to transmit on the selected channel, then release to receive. The TX indicator appears while transmitting.

The radio is equipped with a timeout timer as per regulatory requirements. After **PTT** has been held continuously for 5 minutes, transmission is discontinued and the radio automatically returns to receive mode. An Error beep is emitted 10 seconds before the time out is triggered and TX flashes on the display until **PTT** is released.

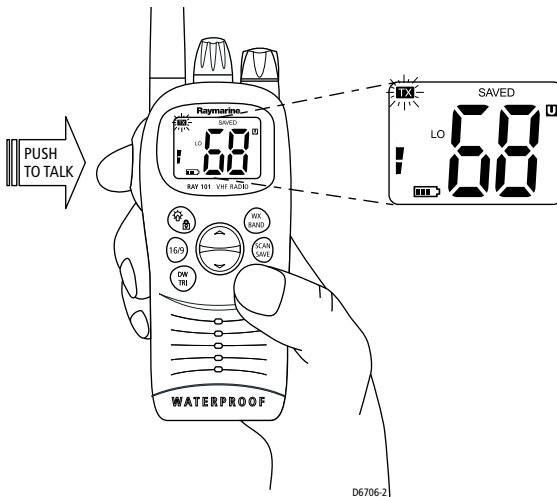

The TX time out timer is reset once the **PTT** key is released.

Note: If the current channel is a TX-prohibited channel, an alarm sounds when PTT is pressed, indicating such a transmission is not permitted.

4.11 Turning On the Backlight



To toggle the display's Backlight ON or OFF, press and release the  key.

When the Backlight setting is enabled, any key press except **PTT** turns on the backlight for 5 seconds. If a key is pressed within the time frame, the time out is reset.

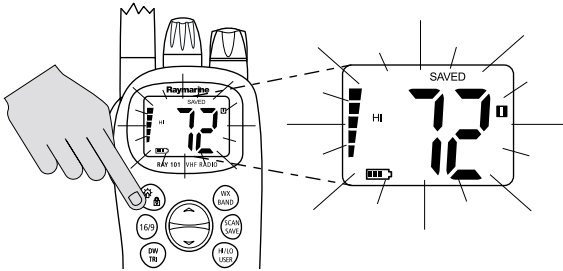

Press and release

4.12 Turning On the Keylock



To toggle the Keylock ON or OFF, press and hold the  key for 3 seconds. When Keylock is enabled, the lock icon appears on the display.

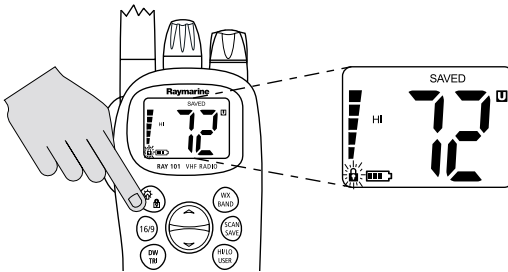

Press and hold

The Keylock setting protects the radio from any keypad entry except for **PTT** and the backlight function.

Then, press and hold the  key again for 3 seconds to cancel the keylock.

4.13 Using the Scan Modes



The RAY101 is equipped with three types of scan options: All Scan, Saved (Memory) Scan and Priority Scan. If there are no channels in memory, the default is All Scan.

This function automatically searches for transmissions on the channel set being scanned. If a TX signal is received, the scan stops on the receiving channel as long as it is present and the SCAN indicator flashes. If the signal is lost for five seconds, the radio resumes scanning.

During the Scan Modes:

- Press the Channel UP/DOWN key to change the scan direction. UP increments the channel while DOWN decrements it.
- Press and release **SCAN/SAVE** to terminate the SCAN mode.
- **DW/TRI** and **WX/BAND** keys do not function and sound an error beep if pressed.

All Scan

Press and release the **SCAN/SAVE** key when no channels are stored in memory to activate the All Scan function.

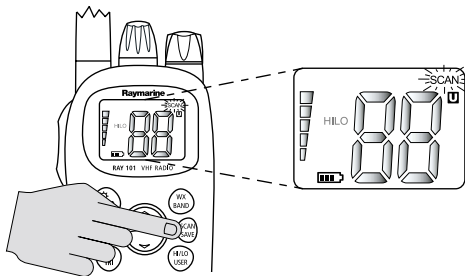

Press and release

The SCAN indicator appears on the LCD during All Scan.

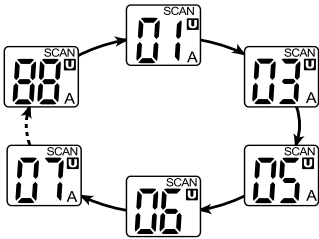

In All Scan mode, all channels in the channel set are scanned in sequence, assuming no channels have been stored in memory. After the last channel number has been scanned, the cycle repeats.

All Scan is demonstrated in the figure to the left.

Note: Whenever Weather Alert is activated, the WX Alert channel is also monitored during All Scan. If the WX Alert tone is detected, the scan is halted to broadcast the Weather Alert message.

Saved (Memory) Scan

Press and release the **SCAN/SAVE** key when there is at least one channel in memory to activate the Saved Scan function.

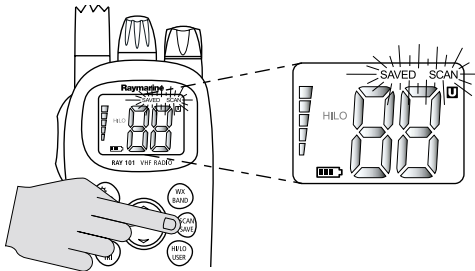

Press and release

In Saved Scan Mode, the **SAVED** and **SCAN** indicators appear on the LCD.

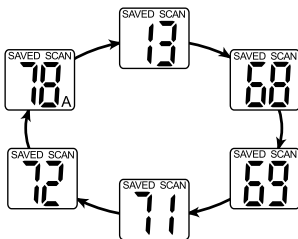

In Saved Scan mode, only the channels that have been saved in memory are scanned in sequence. After the last saved channel number has been scanned, the cycle repeats.

Saved Scan is demonstrated in the figure to the left.

Note: Whenever Weather Alert is activated, the WX Alert channel is also monitored during Saved Scan. If the WX Alert tone is detected, the scan is halted to broadcast the Weather Alert message.

Priority All Scan



Press and hold the **SCAN/SAVE** key while All Scan is active to initiate Priority Scan.

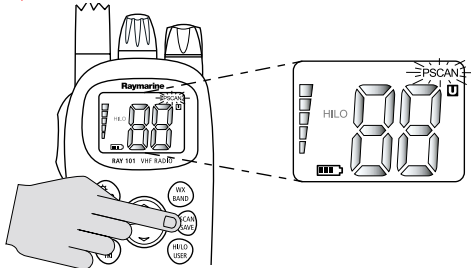

Press and hold

During Priority Scan, the PSCAN indicator appears on the LCD.

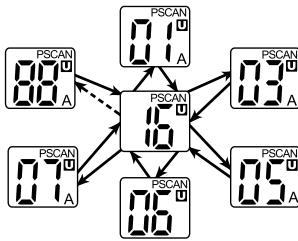

Priority Scan searches for activity on all channels but alternates scanning the Priority Channel 16 after each channel.

Priority Scan is demonstrated in the figure to the left.

Note: Whenever Weather Alert is activated, the WX Alert channel is also monitored during Priority All Scan. If the WX Alert tone is detected, the scan is halted to broadcast the Weather Alert message.

Priority Saved Scan

Press and hold the **SCAN/SAVE** key while Saved Scan is active to initiate Priority Saved Scan.

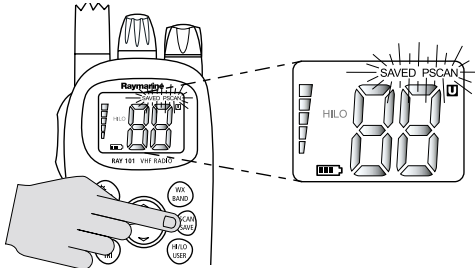

Press and hold

The PSCAN and SAVED indicators appear on the LCD.

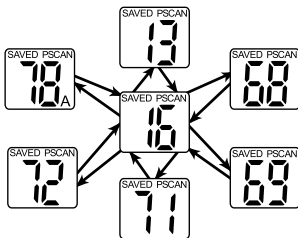

Priority Saved Scan is much like Priority Scan except that the radio alternates searching for activity on the Priority Channel 16 and the channels stored in memory.

Priority Saved Scan is demonstrated in the figure to the left.

Note: Whenever Weather Alert is activated, the WX Alert channel is also monitored during Priority Saved Scan. If the WX Alert tone is detected, the scan is halted to broadcast the Weather Alert message.

Press and hold **SCAN/SAVE** for 3 seconds to exit Priority/Priority Saved Scan and return to All/Memory Scan.

4.14 Adding Channels to Memory



The Ray101 can store any channel except the weather channels. The stored channels are the ones scanned in the Saved (Memory) Scan mode.

- To add channels to memory:
 1. During normal operation mode, use the UP/DOWN key to select the desired channel for programming.
 2. Press and hold the **SCAN/SAVE** key for 3 seconds.

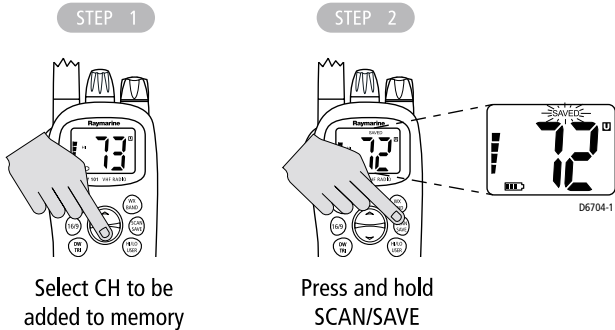

The **SAVED** icon appears to indicate the current channel has been saved in memory. Any number of channels can be saved as memory channels. Separate memory channel groups exist for USA, International, and Canadian frequency sets.

- To delete channels from memory:
 1. During the normal mode, use the UP/DOWN key to select the channel to be deleted.
 2. Press and hold the **SCAN/SAVE** key for 3 seconds.

The selected channel is deleted from memory. To view the channels set in memory, switch to **USER** mode, as described in *Section 4.16, USER Channel Mode*.

4.15 Using the Monitor Modes



The Watch Modes monitor the programmed Priority Channel and other user-selected channel(s). The watch is halted when activity is detected on a monitored channel. The Ray101 is equipped with 2 types of monitor operations: Dual Watch and Tri Watch.

Dual Watch

Press and release the **DW/TRI** key to activate the Dual Watch mode.

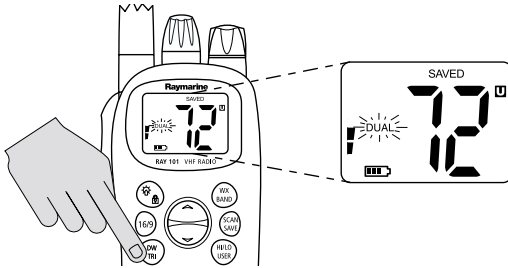

Press and release

The DUAL indicator appears on the LCD.

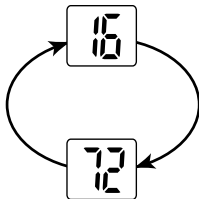

Dual Watch monitors the current working channel and Channel 16 in cycle.

Dual Watch is demonstrated in the figure to the left; the sample working channel is CH 72. Whenever Weather Alert is activated, the WX Alert channel is also monitored during Dual Watch.

Press and release the **DW/TRI** key to terminate Dual Watch and return to the previous working channel.

Press and hold the **DW/TRI** key to terminate Dual Watch mode and go into Tri Watch mode.

Press and release the **16/9** key to terminate Dual Watch mode and switch to the Priority Channel.

Note: During Dual Watch mode, the SCAN/SAVE, USER, WX/BAND, and Channel UP/DOWN keys are inactive and sounds an error beep if pressed.

Tri Watch

Press and hold the **DW/TRI** key for 3 seconds to activate Tri Watch mode.

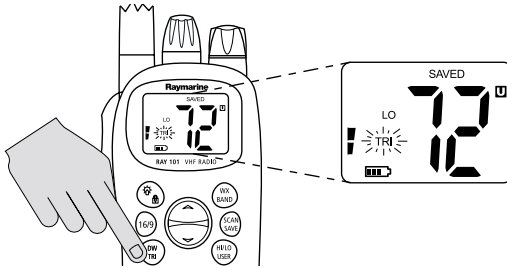

Press and hold

The TRI indicator appears on the LCD.

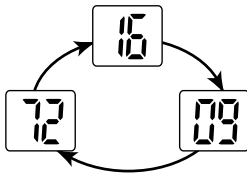

Tri Watch monitors in cycle Channel 16, the current working channel and the channel you have set as the Secondary Priority Channel.

Tri Watch is demonstrated in the figure to the left; the sample working channel is CH 72.

Note: *Whenever Weather Alert is activated, the WX Alert channel is also monitored during Tri Watch.*

Press and release the **DW/TRI** key to terminate Tri Watch and return to the previous working channel.

Press and release the **16/9** key to terminate Tri Watch mode and switch to the Priority Channel.

Note: *During Tri Watch Mode, the SCAN/SAVE, USER, WX/BAND, and Channel UP/DOWN keys are inactive and sounds an error beep if pressed.*

4.16 USER Channel Mode



Press and hold the **HI/LO / USER** key while in normal operation mode to enter User Mode. The USER and SAVED indicators appear.

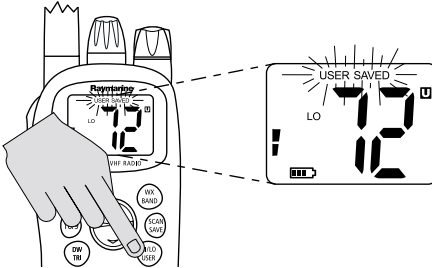

Press and hold

USER Channel Mode displays only the channels that you have saved to memory, which enables you to easily use your favorite channels while bypassing unwanted or seldom-used channels during a scan.

Note: *The procedure for saving a channel to memory is outlined in Section 4.14, Adding Channels to Memory.*

While in User Mode:

- Press and release the **SCAN/SAVE** key to start Memory Scan mode.
- Press and release the Channel UP or Channel DOWN key to scroll through the saved channels.
- Press and hold the **SCAN/SAVE** key to delete the current channel from memory list.
- Press **16/9** to terminate User mode and switch to the Priority Channel.

Note: *You cannot switch Channel sets while in User Mode. The WX/BAND key does not function and sounds an error beep if pressed.*

Press and hold the **HI/LO / USER** key for 3 seconds to quit User mode and return to the last-used working channel.

4.17 Resetting Factory Defaults

You can reset many radio settings back to their factory defaults:

- Erase any channels stored in memory
- Return to US channels, if another mode is selected
- Turn OFF the Weather Alert setting, if active
- Return power settings to their original state

► To perform the reset:

1. Turn the radio OFF.
2. Simultaneously press and hold the **HI/LO / USER** and **WX/BAND** keys.
3. While continuing to hold these keys, power the radio ON.

The LCD remains blank for 2 seconds, and then the unit switches to channel 16.

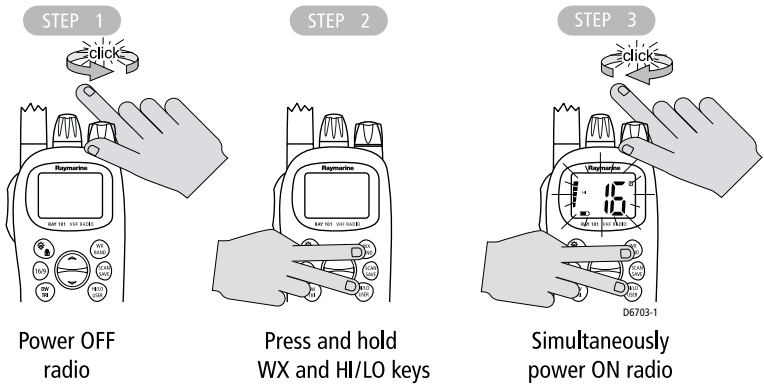

Chapter 5: Customer Service

This chapter provides information on service for your Ray101.

5.1 How to Contact Raymarine

On the Internet

Visit the Raymarine World Wide Web site for the latest information on Raymarine electronic equipment and systems at:

www.raymarine.com

Customer Support

Navigate to the Customer Support page for links for:

- Finding Factory Service locations and Authorized Dealers near you
- Registering your Raymarine products
- Accessing handbooks in Adobe Acrobat format
- Downloading RayTech software updates
- Accessing the Raymarine solution database

Clicking the Find Answers link routes you to our solution database. Search questions and answers by product, category, keywords, or phrases. If the answer you are seeking is not available, click the Ask Raymarine tab to submit your own question to our technical support staff, who will reply to you by e-mail.

Accessories and Parts

Many Raymarine accessory items and parts can be obtained directly from your authorized Raymarine dealer.

However, if you are in need of an item not available from the retailer, please contact Raymarine Technical Services at:

1-800-539-5539 ext. 2333, *or*

1-603-881-5200 ext. 2333

Please have the Raymarine item or part number ready when calling if placing an order. If you are not sure which item is appropriate for your unit, you should first contact the Technical Support Department to verify your requirements.

Technical Support

For technical support, call:

1-800-539-5539 ext. 2444, *or*
1-603-881-5200 ext. 2444

Our Technical Support Specialists are available to answer questions about installing, operating and trouble-shooting all Raymarine products. Technical Service is available Monday through Friday 4:00 AM to 6:00 PM Eastern Time.

Questions can be sent directly to our Technical Support Department via the Internet. Point your browser to www.raymarine.com and click on the Customer Support link. From there, select Find Answers and click the Ask Raymarine tab.

Product Repair and Service

In the unlikely event your Raymarine unit should develop a problem, please contact your authorized Raymarine dealer for assistance. The dealer is best equipped to handle your service requirements and can offer timesaving help in getting the equipment back into normal operation.

In the event that repairs can not be obtained conveniently, product service may also be obtained by returning the unit to:

Raymarine, Inc.
Product Repair Center
22 Cotton Road, Unit D
Nashua, NH 03063-4219

The Product Repair Center is open Monday through Friday 8:15 a.m. to 5:00 p.m. Eastern Time. All products returned to the Repair Center are registered upon receipt. Should you wish to inquire about the repair status of your unit, contact the Product Repair Center at:

1-800-539-5539 ext. 2118, *or*
1-603-881-5200 ext. 2118

Please have the product reference number, or unit serial number, ready when you call. We will do everything possible to repair and return your unit quickly.

Appendix A: Specifications

General

| | |
|---|---|
| Size (H x W x D) | 5.55" (141mm) x 2.4" (61mm) x 1.69" (43mm) without antenna |
| Weight | 12.8 oz (0.36 kg) |
| Power Source | 7.2V DC (6 x AA Alkaline or AA Ni-MH Batteries) |
| Environmental: Operating Range: Storage Range: Humidity: | Waterproof to IPX7 +5°F to 131°F (-15°C to +55°C) -4°F to +158°F (-20°C to +70°C) up to 95% at 35°C non-condensing |
| Frequency Range: Transmit Receive | 156.025 To 157.425 MHz 156.050 To 163.275 MHz |
| Channels | 50 US, 60 Canadian and 55 International VHF Marine Band. Also, 10 Weather Channels (with weather alert). |
| Modulation | FM 16K0G3E |
| Channel Spacing | 25 kHz Increments |
| Antenna Socket | SMA |
| Display | 38.4mm x 48.3mm LCD |
| Built in Speaker | Ø40mm / Impedance 8 Ohm |

Receiver

| | |
|-----------------------------------|--|
| Sensitivity (12dB SINAD) | 0.30µV |
| Squelch Sensitivity (threshold) | 10 (± 2) dB SINAD |
| Audio Output Power At THD 5% | >= 250 mW |
| Max S/N ratio @ 1 mV | 40 dB |
| Audio Response | @300Hz + 6 dB ± 3 @2500Hz -11dB ± 3 |
| Spurious Response Rejection Ratio | 70 dB |
| Adjacent Channel Selectivity | 70 dB |
| Intermodulation Rejection Ratio | 68 dB |

| | |
|-----------------------|-----------------------------|
| Scan Time per Channel | 200 ms |
| Speaker Jack output | 1.8 V (8ohm load @ max vol) |
| Current Drain at: | |
| Max Audio Power | 200 mA |
| Standby | 40 mA |

Transmitter

| | | |
|--------------------------------|----------|-----------------|
| RF Power: | | |
| | Hi Mode | 5 W \pm 0.5 |
| | Lo Mode | 1 W \pm 0.2 |
| Carrier Frequency Tolerance | | \pm 10 PPM |
| Maximum Limiting | | \pm 5 KHz |
| Carrier Attack Time | | 80 ms |
| Audio Response | @300Hz | -12dB \pm 3 |
| | @2500Hz | +6 dB \pm 3 |
| Audio Distortion @ 2.5KHz dew. | | 3% |
| Hum and Noise Ratio | | 35 dB |
| Spurious/Harmonic Emissions | | < 60 dB |
| Mic Sensitivity for 3kHz | | 10 mV \pm 3 |
| Conducted Spurious Emission | | <0.25 μ W |
| Transient Frequency Behavior | | |
| | TX on | 30 ms |
| | TX off | 5 ms |
| Current Drain | | |
| | Hi Power | 1800 mA |
| | Lo Power | 700 mA |
| Charging Current | | 750 mA \pm 50 |

Appendix B: Channel List

U.S. VHF Marine Radio Channels and Frequencies

| CH. No | XMIT Freq | RCV Freq | Single Freq | Use |
|--------|-----------|----------|-------------|---|
| 01A | 156.050 | 156.050 | x | Port Operations and Commercial, VTS. Available only in New Orleans / Lower Mississippi area. ¹ |
| 03A | 156.150 | 156.150 | x | U.S. Government only |
| 05A | 156.250 | 156.250 | x | Port Operations or VTS in the Houston, New Orleans and Seattle areas. |
| 06 | 156.300 | 156.300 | x | Intership Safety |
| 07A | 156.350 | 156.350 | x | Commercial |
| 08 | 156.400 | 156.400 | x | Commercial (Intership only) |
| 09 | 156.450 | 156.450 | x | Boater Calling. Commercial and Non-Commercial. |
| 10 | 156.500 | 156.500 | x | Commercial |
| 11 | 156.550 | 156.550 | x | Commercial. VTS in selected areas. |
| 12 | 156.600 | 156.600 | x | Port Operations. VTS in selected areas. |
| 13 | 156.650 | 156.650 | x | Intership Navigation Safety (Bridge-to-bridge). Ships >20meters in length maintain a listening watch on this channel in US waters. ² |
| 14 | 156.700 | 156.700 | x | Port Operations. VTS in selected areas. |
| 15 | – | 156.750 | x | Environmental (Receive only). Used by Class 'C' EPIRBs. |
| 16 | 156.800 | 156.800 | x | International Distress, Safety and Calling. Ships required to carry radio, USCG, and most coast stations maintain a listening watch on this channel. ³ |
| 17 | 156.850 | 156.850 | x | State Control |
| 18A | 156.900 | 156.900 | x | Commercial |
| 19A | 156.950 | 156.950 | x | Commercial |
| 20 | 157.000 | 161.600 | | Port Operations (duplex) |
| 20A | 157.000 | 157.000 | x | Port Operations |
| 21A | 157.050 | 157.050 | x | U.S. Coast Guard only |

| CH. No | XMIT Freq | RCV Freq | Single Freq | Use |
|---------------|------------------|-----------------|--------------------|---|
| 22A | 157.100 | 157.100 | x | Coast Guard Liaison and Maritime Safety Information Broadcasts. Broadcasts announced on channel 16. |
| 23A | 157.150 | 157.150 | x | U.S. Coast Guard only |
| 24 | 157.200 | 161.800 | | Public Correspondence (Marine Operator) |
| 25 | 157.250 | 161.850 | | Public Correspondence (Marine Operator) |
| 26 | 157.300 | 161.900 | | Public Correspondence (Marine Operator) |
| 27 | 157.350 | 161.950 | | Public Correspondence (Marine Operator) |
| 28 | 157.400 | 162.000 | | Public Correspondence (Marine Operator) |
| 61A | 156.075 | 156.075 | x | U.S. Government only |
| 63A | 156.175 | 156.175 | x | Port Operations and Commercial, VTS. Available only in New Orleans / Lower Mississippi area. |
| 64A | 156.225 | 156.225 | x | U.S. Coast Guard only |
| 65A | 156.275 | 156.275 | x | Port Operations |
| 66A | 156.325 | 156.325 | x | Port Operations |
| 67 | 156.375 | 156.375 | x | Commercial. Used for Bridge-to-bridge communications in lower Mississippi River. Intership only. |
| 68 | 156.425 | 156.425 | x | Non-Commercial |
| 69 | 156.475 | 156.475 | x | Non-Commercial |
| 71 | 156.575 | 156.575 | x | Non-Commercial |
| 72 | 156.625 | 156.625 | x | Non-Commercial (Intership only) |
| 73 | 156.675 | 156.675 | x | Port Operations |
| 74 | 156.725 | 156.725 | x | Port Operations |
| 77 | 156.875 | 156.875 | x | Port Operations (Intership only) |
| 78A | 156.925 | 156.925 | x | Non-Commercial |
| 79A | 156.975 | 156.975 | x | Commercial. Non-Commercial in Great Lakes only. |
| 80A | 157.025 | 157.025 | x | Commercial. Non-Commercial in Great Lakes only |
| 81A | 157.075 | 157.075 | x | U.S. Government only – Environmental protection operations. |

| CH. No | XMIT Freq | RCV Freq | Single Freq | Use |
|---------------|------------------|-----------------|--------------------|---|
| 82A | 157.125 | 157.125 | x | U.S. Government only |
| 83A | 157.175 | 157.175 | x | U.S. Coast Guard only |
| 84 | 157.225 | 161.825 | | Public Correspondence (Marine Operator) |
| 85 | 157.275 | 161.875 | | Public Correspondence (Marine Operator) |
| 86 | 157.325 | 161.925 | | Public Correspondence (Marine Operator) |
| 87 | 157.375 | 161.975 | | Public Correspondence Marine Operator) |
| 88 | 157.425 | 162.025 | | Public Correspondence only near Canadian border |
| 88A | 157.425 | 157.425 | x | Commercial, Intership only |

- Boaters should normally use channels listed as Non-Commercial.
- Channels 13 and 67 are initially set to 1 watt output power only. You can temporarily override this restriction to transmit at high power if necessary.
- Channel 70 is used exclusively for Digital Selective Calling (DSC) and is not available for regular voice communications.
- Channels 75 and 76 are reserved as guard bands for Channel 16 and are not available for regular voice communications.

Notes:

1. The letter "A" following a channel number indicates simplex use of the ship station transmit side of an international duplex channel. Operations are different from that of international operations on that channel.
2. Channel 13 should be used to contact a ship when there is danger of collision. All ships of length 20 meters or greater are required to guard VHF channel 13, in addition to VHF channel 16, when operating within U.S. territorial waters.
3. Channel 16 is used to hail other stations or for distress alerting.

Canadian VHF Marine Radio Channels and Frequencies

| CH No. | XMIT Freq | RCV Freq | Area of Operation | Use |
|---------------|------------------|-----------------|--------------------------|---|
| 01 | 156.050 | 160.650 | PC | Public Correspondence |
| 02 | 156.100 | 160.700 | PC | Public Correspondence |
| 03 | 156.150 | 160.750 | PC | Public Correspondence |
| 04A | 156.200 | 156.200 | PC | Intership, Ship/Shore and Safety: Canadian Coast Guard search and rescue ¹ |
| 04A | 156.200 | 156.200 | EC | Intership, Ship/Shore and Commercial: Commercial fishing only |
| 05A | 156.250 | 156.250 | | Ship Movement |
| 06 | 156.300 | 156.300 | All areas | Intership, Commercial, Non-commercial and Safety: May be used for search and rescue communications between ships and aircraft. |
| 07A | 156.350 | 156.350 | All areas | Intership, Ship/Shore, Commercial |
| 08 | 156.400 | 156.400 | WC, EC | Intership, Commercial and Safety: Also assigned for operations in the Lake Winnipeg area. |
| 09 | 156.450 | 156.450 | AC | Intership, Ship/Shore, Commercial, Non-commercial and Ship Movement: May be used to communicate with aircraft and helicopters in predominantly maritime support operations. |
| 10 | 156.500 | 156.500 | AC, GL | Intership, Ship/Shore, Commercial, Non-commercial, Safety and Ship Movement: May also be used for communications with aircraft engaged in coordinated search and rescue and antipollution operations. |
| 11 | 156.550 | 156.550 | PC, AC, GL | Intership, Ship/Shore, Commercial, Non-commercial and Ship Movement: Also used for pilotage purposes. |
| 12 | 156.600 | 156.600 | WC, AC, GL | Intership, Ship/Shore, Commercial, Non-commercial and Ship Movement: Port operations and pilot information and messages. |
| 13 | 156.650 | 156.650 | All areas | Intership, Commercial, Non-commercial and Ship Movement: Exclusively for bridge-to-bridge navigational traffic. |
| 14 | 156.700 | 156.700 | AC, GL | Intership, Ship/Shore, Commercial, Non-commercial and Ship Movement: Port operations and pilot information and messages. |

| CH No. | XMIT Freq | RCV Freq | Area of Operation | Use |
|---------------|------------------|-----------------|--------------------------|--|
| 15 | 156.750 | 156.750 | All areas | Intership, Ship/Shore, Commercial, Non-commercial and Ship Movement: All operations limited to 1-watt maximum power. May also be used for on-board communications. |
| 16 | 156.800 | 156.800 | All areas | International Distress, Safety and Calling ² |
| 17 | 156.850 | 156.850 | All areas | Intership, Ship/Shore, Commercial, Non-commercial and Ship Movement: All operations limited to 1-watt maximum power. May also be used for on-board communications. |
| 18A | 156.900 | 156.900 | All areas | Intership, Ship/Shore and Commercial: Towing on the Pacific Coast. |
| 19A | 156.950 | 156.950 | All areas except PC | Intership and Ship/Shore: Canadian Coast Guard only. |
| 19A | 156.950 | 156.950 | PC | Intership and Ship/Shore: Various Government departments. |
| 20 | 157.000 | 161.600 | All areas | Ship/Shore, Safety and Ship Movement: Port operations only with 1-watt maximum power. |
| 21A | 157.050 | 157.050 | All areas | Intership and Ship/Shore: Canadian Coast Guard only. |
| 21B | - | 161.650 | All areas | Safety: Continuous Marine Broadcast (CMB) service. ³ |
| 22A | 157.100 | 157.100 | All areas | Intership, Ship/Shore, Commercial and Non-commercial: For communications between Canadian Coast Guard and non-Canadian Coast Guard stations only. |
| 23 | 157.150 | 161.750 | PC | Ship/Shore and Public Correspondence: Also in the inland waters of British Columbia and the Yukon. |
| 24 | 157.200 | 161.800 | All areas | Ship/Shore and Public Correspondence |
| 25 | 157.250 | 161.850 | PC | Ship/Shore and Public Correspondence: Also assigned for operations in the Lake Winnipeg area. |
| 25B | - | 161.850 | AC | Safety: Continuous Marine Broadcast (CMB) service. |
| 26 | 157.300 | 161.900 | All areas | Ship/Shore, Safety and Public Correspondence |
| 27 | 157.350 | 161.950 | AC, GL, PC | Ship/Shore and Public Correspondence |
| 28 | 157.400 | 162.000 | PC | Ship/Shore, Safety and Public Correspondence |
| 28B | - | 162.000 | AC | Safety: Continuous Marine Broadcast (CMB) service. |

| CH No. | XMIT Freq | RCV Freq | Area of Operation | Use |
|---------------|------------------|-----------------|--------------------------|--|
| 60 | 156.025 | 160.625 | PC | Ship/Shore and Public Correspondence |
| 61A | 156.075 | 156.075 | PC | Intership and Ship/Shore: Canadian Coast Guard only. |
| 61A | 156.075 | 156.075 | EC | Intership, Ship/Shore and Commercial: Commercial fishing only. |
| 62A | 156.125 | 156.125 | PC | Intership and Ship/Shore: Canadian Coast Guard only. |
| 62A | 156.125 | 156.125 | EC | Intership, Ship/Shore and Commercial: Commercial fishing only. |
| 64 | 156.225 | 160.825 | PC | Ship/Shore and Public Correspondence |
| 64A | 156.225 | 156.225 | EC | Intership, Ship/Shore and Commercial: Commercial fishing only. |
| 65A | 156.275 | 156.275 | | Intership, Ship/Shore, Commercial, Non-commercial, Safety: Search & rescue and antipollution operations on the Great Lakes. Towing on the Pacific Coast. Port operations only in the St. Lawrence River areas with 1W maximum power. Pleasure craft in the inland waters of Alberta, Saskatchewan and Manitoba (excluding Lake Winnipeg and the Red River). |
| 66A | 156.325 | 156.325 | | Intership, Ship/Shore, Commercial, Non-commercial, Safety and Ship Movement: Port operations only in the St.Lawrence River/Great Lakes Areas with 1-watt maximum power. |
| 67 | 156.375 | 156.375 | EC | Intership, Ship/Shore and Commercial: Commercial fishing only. |
| 67 | 156.375 | 156.375 | All areas except EC | Intership, Ship/Shore, Commercial, Non-commercial, Safety: May also be used for communications with aircraft engaged in coordinated search and rescue and antipollution operations. |
| 68 | 156.425 | 156.425 | All areas | Intership, Ship/Shore and Non-commercial: For marinas and yacht clubs. |
| 69 | 156.475 | 156.475 | All areas except EC | Intership, Ship/Shore, Commercial and Non-commercial |
| 69 | 156.475 | 156.475 | EC | Intership, Ship/Shore and Commercial: Commercial fishing only. |
| 71 | 156.575 | 156.575 | PC | Intership, Ship/Shore, Commercial, Non-commercial, Safety and Ship Movement |

| CH No. | XMIT Freq | RCV Freq | Area of Operation | Use |
|---------------|------------------|-----------------|--------------------------|---|
| 71 | 156.575 | 156.575 | | Intership, Ship/Shore and Non-commercial: For marinas and yacht clubs on the East Coast and on Lake Winnipeg. |
| 72 | 156.625 | 156.625 | EC, PC | Intership, Commercial and Non-commercial: May be used to communicate with aircraft and helicopters in predominantly maritime support operations. |
| 73 | 156.675 | 156.675 | EC | Intership, Ship/Shore and Commercial: Commercial fishing only |
| 73 | 156.675 | 156.675 | All areas except EC | Intership, Ship/Shore, Commercial, Non-commercial, Safety: May also be used for communications with aircraft engaged in coordinated search and rescue and antipollution operations. |
| 74 | 156.725 | 156.725 | EC, PC | Intership, Ship/Shore, Commercial, Non-commercial and Ship Movement. |
| 77 | 156.875 | 156.875 | | Intership, Ship/Shore, Safety and Ship Movement: Pilotage on Pacific Coast. Port operations only in the St. Lawrence River/Great Lakes areas with 1W maximum power. |
| 78A | 156.925 | 156.925 | EC, PC | Intership, Ship/Shore and Commercial |
| 79A | 156.975 | 156.975 | EC, PC | Intership, Ship/Shore and Commercial |
| 80A | 157.025 | 157.025 | EC, PC | Intership, Ship/Shore and Commercial |
| 81A | 157.075 | 157.075 | | Intership and Ship/Shore: Canadian Coast Guard use only in the St. Lawrence River/Great Lakes areas. |
| 81A | 157.075 | 157.075 | PC | Intership, Ship/Shore and Safety: Canadian Coast Guard antipollution. |
| 82A | 157.125 | 157.125 | PC | Intership, Ship/Shore and Safety: Canadian Coast Guard use only. |
| 82A | 157.125 | 157.125 | | Intership and Ship/Shore: Canadian Coast Guard use only in the St. Lawrence River/Great Lakes areas. |
| 83 | 157.175 | 161.775 | PC | Ship/Shore and Safety: Canadian Coast Guard use only. |
| 83A | 157.175 | 157.175 | EC | Intership and Ship/Shore: Canadian Coast Guard and other Government agencies. |
| 83B | - | 161.775 | AC, GL | Safety: Continuous Marine Broadcast (CMB) Service. |
| 84 | 157.225 | 161.825 | PC | Ship/Shore and Public Correspondence |

| CH No. | XMIT Freq | RCV Freq | Area of Operation | Use |
|---------------|------------------|-----------------|--------------------------|--------------------------------------|
| 85 | 157.275 | 161.875 | AC, GL, NL | Ship/Shore and Public Correspondence |
| 86 | 157.325 | 161.925 | PC | Ship/Shore and Public Correspondence |
| 87 | 157.375 | 161.975 | AC, GL, NL | Ship/Shore and Public Correspondence |
| 88 | 157.425 | 162.025 | AC, GL, NL | Ship/Shore and Public Correspondence |

Area of Operation

AC: Atlantic Coast, Gulf and St. Lawrence River up to and including Montreal

EC (East Coast): includes NL, AC, GL and Eastern Arctic areas

GL: Great Lakes (including St. Lawrence above Montreal)

NL: Newfoundland and Labrador

PC: Pacific Coast

WC (West Coast): Pacific Coast, Western Arctic and Athabasca-Mackenzie Watershed areas

All areas: includes East and West Coast areas

Notes:

- 1. The letter "A" following a channel number indicates simplex use of the ship station transmit side of an international duplex channel. Operations are different from that of international operations on that channel.*
- 2. Channel 16 is used for calling other stations or for distress alerting.*
- 3. The letter "B" following a channel number indicates simplex use of the coast station transmit side of an international duplex channel. That is, the channel is Receive Only.*
- 4. Channel 70 is used exclusively for Digital Selective Calling (DSC) and is not available for regular voice communications.*
- 5. Channels 75 and 76 are reserved as guard bands for Channel 16 and are not available for regular voice communications.*

International VHF Marine Radio Channels & Frequencies

| CH No. | XMIT Freq | RCV Freq | Single Freq | Use |
|---------------|------------------|-----------------|--------------------|--|
| 01 | 156.050 | 160.650 | | Public Correspondence, Port Operations and Ship Movement |
| 02 | 156.100 | 160.700 | | Public Correspondence, Port Operations and Ship Movement |
| 03 | 156.150 | 160.750 | | Public Correspondence, Port Operations and Ship Movement |
| 04 | 156.200 | 160.800 | | Public Correspondence, Port Operations and Ship Movement |
| 05 | 156.250 | 160.850 | | Public Correspondence, Port Operations and Ship Movement |
| 06 | 156.300 | 156.300 | x | Intership ¹ |
| 07 | 156.350 | 160.950 | | Public Correspondence, Port Operations and Ship Movement |
| 08 | 156.400 | 156.400 | x | Intership |
| 09 | 156.450 | 156.450 | x | Intership, Port Operations and Ship Movement |
| 10 | 156.500 | 156.500 | x | Intership, Port Operations and Ship Movement ² |
| 11 | 156.550 | 156.550 | x | Port Operations and Ship Movement |
| 12 | 156.600 | 156.600 | x | Port Operations and Ship Movement |
| 13 | 156.650 | 156.650 | x | Intership Safety, Port Operations and Ship Movement ³ |
| 14 | 156.700 | 156.700 | x | Port Operations and Ship Movement |
| 15 | 156.750 | 156.750 | x | Intership and On-board Communications at 1W only ⁴ |
| 16 | 156.800 | 156.800 | x | Distress, Safety and Calling |
| 17 | 156.850 | 156.850 | x | Intership and On-board Communications at 1W only ⁴ |
| 18 | 156.900 | 161.500 | | Public Correspondence |
| 19 | 156.950 | 161.550 | | Public Correspondence, Port Operations and Ship Movement |
| 20 | 157.000 | 161.600 | | Public Correspondence, Port Operations and Ship Movement |
| 21 | 157.050 | 161.650 | | Public Correspondence, Port Operations and Ship Movement |
| 22 | 157.100 | 161.700 | | Public Correspondence, Port Operations and Ship Movement |
| 23 | 157.150 | 161.750 | | Public Correspondence, Port Operations and Ship Movement |
| 24 | 157.200 | 161.800 | | Public Correspondence, Port Operations and Ship Movement |

| CH No. | XMIT Freq | RCV Freq | Single Freq | Use |
|---------------|------------------|-----------------|--------------------|--|
| 25 | 157.250 | 161.850 | | Public Correspondence, Port Operations and Ship Movement |
| 26 | 157.300 | 161.900 | | Public Correspondence, Port Operations and Ship Movement |
| 27 | 157.350 | 161.950 | | Public Correspondence, Port Operations and Ship Movement |
| 28 | 157.400 | 162.000 | | Public Correspondence, Port Operations and Ship Movement |
| 60 | 156.025 | 160.625 | | Public Correspondence, Port Operations and Ship Movement |
| 61 | 156.075 | 160.675 | | Public Correspondence, Port Operations and Ship Movement |
| 62 | 156.125 | 160.725 | | Public Correspondence, Port Operations and Ship Movement |
| 63 | 156.175 | 160.775 | | Public Correspondence, Port Operations and Ship Movement |
| 64 | 156.225 | 160.825 | | Public Correspondence, Port Operations and Ship Movement |
| 65 | 156.275 | 160.875 | | Public Correspondence, Port Operations and Ship Movement |
| 66 | 156.325 | 160.925 | | Public Correspondence, Port Operations and Ship Movement |
| 67 | 156.375 | 156.375 | x | Intership, Port Operations and Ship Movement |
| 68 | 156.425 | 156.425 | x | Port Operations and Ship Movement |
| 69 | 156.475 | 156.475 | x | Port Operations and Ship Movement |
| 71 | 156.575 | 156.575 | x | Port Operations and Ship Movement |
| 72 | 156.625 | 156.625 | x | Intership |
| 73 | 156.675 | 156.675 | x | Intership ² |
| 74 | 156.725 | 156.725 | x | Port operations and Ship movement |
| 75 | 156.775 | 156.775 | x | See Note 5 |
| 76 | 156.825 | 156.825 | x | See Note 5 |
| 77 | 156.875 | 156.875 | x | Intership |
| 78 | 156.925 | 161.525 | | Public correspondence, Port Operations and Ship Movement |
| 79 | 156.975 | 161.575 | | Public correspondence, Port Operations and Ship Movement |
| 80 | 157.025 | 161.625 | | Public correspondence, Port Operations and Ship Movement |
| 81 | 157.075 | 161.675 | | Public correspondence, Port Operations and Ship Movement |
| 82 | 157.125 | 161.725 | x | Public correspondence, Port Operations and Ship Movement |

| CH No. | XMIT Freq | RCV Freq | Single Freq | Use |
|---------------|------------------|-----------------|--------------------|--|
| 83 | 157.175 | 161.775 | x | Public correspondence, Port Operations and Ship Movement |
| 84 | 157.225 | 161.825 | x | Public correspondence, Port Operations and Ship Movement |
| 85 | 157.275 | 161.875 | x | Public correspondence, Port Operations and Ship Movement |
| 86 | 157.325 | 161.925 | x | Public correspondence, Port Operations and Ship Movement |
| 87 | 157.375 | 157.375 | | Port Operations and Ship Movement |
| 88 | 157.425 | 157.425 | | Port Operations and Ship Movement |

- Intership channels are for communications between ship stations. Intership communications should be restricted to Channels 6, 8, 72 and 77. If these are not available, the other channels marked for Intership may be used.
- Channels 10, 67 and 73 should be avoided within VHF range of coastal areas in Europe and Canada.
- Channel 70 is used exclusively for Digital Selective Calling (DSC) and is not available for regular voice communications.

Notes:

1. Channel 06 may also be used for communications between ship stations and aircraft engaged in coordinated search and rescue operations. Ship stations should avoid harmful interference to such communications on channel 06 as well as to communications between aircraft stations, ice breakers and assisted ships during ice seasons.
2. Channels 10 or 73 (depending on location) are also used for the broadcast of Marine Safety Information by the Maritime and Coast Guard Agency in the UK only.
3. Channel 13 is designated for use on a worldwide basis as a navigation safety communication channel, primarily for intership navigation safety communications.
4. Channels 15 and 17 may also be used for on-board communications provided the effective radiated power does not exceed 1 Watt.
5. The use of Channels 75 and 76 should be restricted to navigation related communication only and all precautions should be taken to avoid harmful interference to channel 16. Transmit power is limited to 1 Watt.

WX Channels (North America only)

| Weather Channel | Frequency in MHz |
|------------------------|-------------------------|
| WX 1 | 162.550 |
| WX 2 | 162.400 |
| WX 3 | 162.475 |
| WX 4 | 162.425 |
| WX 5 | 162.450 |
| WX 6 | 162.500 |
| WX 7 | 162.525 |
| WX 8 | 161.650 |
| WX 9 | 161.775 |
| WX 10 | 163.275 |

Appendix C: Glossary

| Term | Meaning |
|------------------------|---|
| All Scan | A feature that scans all channels. |
| Canadian Channels | Channel designator as defined by Industry Canada. |
| CH | Channel selection key |
| Dual Watch | A feature that monitors the Priority Channel 16 while working on another channel. |
| Duplex | Transmit and receive on different frequencies |
| FCC | Federal Communications Commission (US) |
| International Channels | Channel designator as defined by the ITU |
| ITU | International Telecommunications Union |
| LCD | Liquid Crystal Display |
| NOAA | National Oceanographic and Atmospheric Administration (USA) |
| Priority Channel | Channel 16 or 9 (or other secondary channel you have programmed) |
| Priority Mode | Initiated by pressing the 16/9 key, this mode instantly places the radio at Channel 16 at high power. |
| Priority Scan (PSCAN) | A feature that alternates monitoring the Priority Channel 16 with each of the regular channels |
| PTT switch | Microphone Push-To-Talk switch |
| RF | Radio Frequency |
| RX | Receive |
| Saved Scan | Scans only user-selected memory channels |
| Simplex | Transmit and receive on the same frequency |
| Squelch | A circuit that sets the threshold for cutting off the receiver when the signal is too weak for reception of anything but noise. |
| TX | Transmit |
| Tri Watch | A function that monitors the Priority Channel and Secondary Priority Channel while working on another channel. |
| US Channels | Channel designations as defined by the FCC. |

| Term | Meaning |
|-----------------------|---|
| VOL | Volume key |
| VHF | Very High Frequency (30MHz to 300MHz) |
| Weather (WX) Channels | Channels for routine and emergency weather information broadcast by NOAA (USA). |
| WX | Weather Band key |
| Working Channel | The currently-selected (non-priority, non-WX) channel. |

Index

Symbols

- "A" indicator 27
- "B" indicator 27
- "C" indicator 27
- "I" indicator 27
- "P" indicator 27
- "U" indicator 27

Numerics

- 16/9 key 25

A

- Accessories 47
- Adding channels to memory 40
- ALERT indicator 28
- All Scan function 37
- Antenna 15
- ATIS
 - Indicator 28

B

- Backlight 25, 36
- BAND function 33
- Battery 16
 - Charging 19
 - Level indicator 27
 - Tray 17
 - Type switch 17
- Belt Clip 16

C

- Canadian channels 54
- Canadian licensing 13
- CH indicator 27
- Channel List
 - Canadian frequencies 54
 - International frequencies 59
 - US frequencies 51
 - WX frequencies 62
- Channel Sets 33

- Channel setting 31
- Channel UP/DOWN 25
- Charging batteries 19
- Conventions 7
- Customer Support 47

D

- Delete channels from memory 41
- DUAL indicator 28
- Dual Watch 25, 42

E

- Equipment supplied 15

F

- Factory reset 45
- Features 11
- Frequency Band 33
- Frequency settings
 - Canadian channels 54
 - International channels 59
 - US channels 51
 - WX channels 62

G

- Glossary 63

H

- Help from Raymarine 47
- HI/LO / USER key 25
- HI/LO indicator 28
- HI/LOW power selection 25, 30

I

- Installation 15
- International channels 59

K

- Keylock 25, 36
- Keylock indicator 28

L

- LCD display 26
- Licensing requirements 12

M

Memory 40
Monitor modes 42, 43

P

Power 24
Power ON/OFF 29
Power selection 30
Priority Channel 33
Priority Mode 27, 33
Priority Scan function 39
PSCAN indicator 27
PTT 24, 35
Push-To-Talk key 35

R

Raymarine
 Addresses 48
 Phone numbers 48
 Website 47
Recharging batteries 19
Repair 48
Reset 45
RX indicator 26

S

Save channels to memory 40
SAVED indicator 27
Saved Scan function 38
Scan function 37
SCAN indicator 27
SCAN/SAVE key 25
Service 48
Signal strength 28
Squelch 24, 30

T

Technical Support 48
Transmitting 35
TRI indicator 28
Tri Watch 25, 43
TX 35
TX indicator 26

U

US channels 51
USER Channel Mode 25, 44
USER indicator 26

V

Volume 29

W

Warning 8
Warranty 7
Weather Channels 31
Website 47
Wrist Strap 16
WX 31
 channels 62
 indicator 28
WX/BAND key 25