

DS600X

Digital Fishfinder

Owner's Handbook

Document number: 81235-2

Date: April 2004

Preface

This handbook describes the Raymarine DS600X Digital Fishfinder.

Conventions Used

Throughout this handbook, the labelled keys are shown in bold capitals; for example, **MENU**. The software menu names and options are shown in normal capitals; for example, AUTOMATIC.

Operating procedures, which may consist of a single key-press or a sequence of numbered steps, are indicated by a ► symbol in the margin.

Technical Accuracy

The technical and graphical information contained in this handbook, to the best of our knowledge, was correct as it went to press. However, the Raymarine policy of continuous improvement and updating may change product specifications without prior notice. As a result, unavoidable differences between the product and handbook may occur from time to time, for which liability cannot be accepted by Raymarine.

Warranty

To register your DS600X Digital Fishfinder ownership, please take a few minutes to fill out the warranty registration card found at the end of this handbook. It is very important that you complete the owner information and return the card to the factory in order to receive full warranty benefits.

Important Information

This handbook contains important information on the installation and operation of your new equipment. In order to obtain the best results in operation and performance, please read this handbook thoroughly.

Raymarine's Product Support representatives, or your authorized dealer, are available to answer any questions you may have.

Intended Use

Raymarine DS600X Digital Fishfinders are intended for recreational fishfinding.

EMC Conformance

All Raymarine equipment and accessories are designed to the best industry standards for use in the recreational marine environment.

Their design and manufacture conforms to the appropriate Electromagnetic Compatibility (EMC) standards, but correct installation is required to ensure that performance is not compromised. Although every effort has been taken to ensure that they will perform under all conditions, it is important to understand what factors could affect the operation of the product.

The guidelines given here describe the conditions for optimum EMC performance, but it is recognized that it may not be possible to meet all of these conditions in all situations. To ensure the best possible conditions for EMC performance within the constraints imposed by any location, always ensure the maximum separation possible between different items of electrical equipment.

For **optimum** EMC performance, it is recommended that **wherever possible**:

- Raymarine equipment and cables connected to it are:
- At least 3 ft (1 m) from any equipment transmitting or cables carrying radio signals, e.g., VHF radios, cables and antennas.
- More than 7 ft (2 m) from the path of a radar beam. A radar beam can normally be assumed to spread 20 degrees above and below the radiating element.

- Raymarine specified cables are used. Cutting and rejoining these cables can compromise EMC performance and must be avoided unless doing so is detailed in the installation manual.
- If a suppression ferrite is attached to a cable, this ferrite should not be removed. If the ferrite needs to be removed during installation it must be reassembled in the same position.

Safety Notices

1. PRODUCT INSTALLATION. This equipment must be installed and operated in accordance with the instructions contained in this handbook. Failure to do so could result in poor product performance, personal injury and/or damage to your boat.



2. HIGH VOLTAGE. The display unit, transducer cable, and transducer contain high voltages. Adjustments require specialized service procedures and tools only available to qualified service technicians - there are no user serviceable parts or adjustments.

3. NAVIGATION AID. This unit is only an aid to navigation. Its accuracy can be affected by many factors, including equipment failure or defects, environmental conditions, and improper handling or use. It is the user's responsibility to exercise common prudence and navigational judgments. This fishfinder should not be relied upon as a substitute for such prudence and judgment.

4. ULTRASONIC ENERGY. The transducer transmits high frequency energy while in use. The unit should be turned off when swimmers or divers are in close proximity to the transducer. (There is a lack of scientifically sound standards or guidelines for exposure levels and limits to ultrasound. This notice is precautionary only.)



WARNING:

Do not disconnect the transducer cable without first powering off the display unit. Removal of the transducer cable from the DS600X while power is turned on can cause sparks.

Mount unit where it is well ventilated and free from gasoline fumes.

Raymarine Products and Services

Raymarine products are supported by a network of Authorized Service Representatives. Raymarine's Technical Services representatives or your local dealer will be available to answer any questions you may have. For information on Raymarine products and services, contact either of the following:

United States

Raymarine, Incorporated
22 Cotton Road, Unit D
Nashua, New Hampshire
03063-4219 USA
Telephone: 1-603-881-5200
1-800-539-5539
Fax: 1-603-864-4756

Europe

Raymarine Limited
Anchorage Park
Portsmouth, Hampshire
PO3 5TD England
Telephone: +44 (0) 23 9269 3611
Fax: +44 (0) 23 9269 4642

Or, you may contact us on the World Wide Web at:

www.raymarine.com

Contents

Preface	iii
Conventions Used	iii
Technical Accuracy	iii
Warranty	iii
Important Information	iv
Intended Use	iv
EMC Conformance	iv
Safety Notices	v
Raymarine Products and Services	vi
Chapter 1: Overview	1
1.1 Introduction	1
Features	2
General	3
Transducer	3
Chapter 2: Installation	5
2.1 Introduction	5
2.2 Unpacking and Inspecting the Components	5
2.3 Selecting the Equipment Location	6
Mounting Location	6
2.4 Cable Runs	7
2.5 Mounting the Fishfinder	9
Bracket Mounting	9
Console Mounting (optional)	9
2.6 System Connections	11
DC Power and NMEA Connection	11
Transducer Connection	13
Chapter 3: Getting Started	15
3.1 Introduction	15
3.2 Powering on the Fishfinder	15
3.3 Simulator Mode	15
3.4 LCD Display	16
3.5 Interpreting the Sounder Image	17
Target Indications	18
3.6 Keypad Operation	19
3.7 Using the Variable Range Marker (VRM)	20
3.8 Selecting the Display Page	21
3.9 Menu Operation	23
Menu Structure	23

Chapter 4: Main Menu	25
4.1 Introduction	25
Selecting MENU Items	25
4.2 Fishfinder Operation Controls	29
Scroll Speed	30
Range	30
Frequency	32
A-Scope	33
GAIN MODE...	34
GAIN	35
Color Gain	35
Time Variable Gain (TVG)	36
Sounder Interference Rejection (Int. Rej.)	36
Second Echo Rejection	37
Power	37
Max. Ping Rate	37
ZOOM...	37
View	38
Zoom x2, x3, x4 Magnification	39
Mode	39
TRIP RESET...	39
DISPLAY SET UP...	39
SOUNDER SET UP...	39
Chapter 5: Display Set Up	41
5.1 Introduction	41
Brightness	44
Target Depth ID	44
Depth Digit Size	45
Transparent Menu	45
PALETTE...	46
Selection	46
Background Color	47
DATA ITEMS...	47
NAV. SET UP... (Navigation Data)	48
Chapter 6: Sounder Set Up	51
6.1 Introduction	51
ALARMS...	55
Target Depth ID	55
Fish Alarm	56
Shallow Alarm	56
Shallow Range	56
Deep Alarm	57

Deep Range	57
Temp. Alarm	57
Temp. Rng. High	58
Temp. Rng. Low	58
ALARM CLOCK	58
UNITS... ..	59
Depth Units	59
Temp. Units	59
Speed Units	59
Distance Units	59
Bearing Mode	60
Date Format	60
Time Format	60
NMEA-OUT SET UP... ..	60
Language	61
Key Beep	61
Key Help	61
Depth Offset	62
Speed Calibrate	62
Temp Calibrate	62
Sounder Simulator	62
SW Version and Serial Number (read only)	62
Chapter 7: Maintenance and Problem Solving	63
7.1 Maintenance	63
Routine Checks	63
Cleaning Instructions	63
Cleaning the Unit	63
Cleaning the Transducer	63
Cleaning the Hull	64
EMC Servicing and Safety Guidelines	64
7.2 Problem Solving	65
Common Problems and Their Solutions	65
7.3 How to Contact Raymarine	66
On the Internet	66
Customer Support	66
In the US	66
Accessories and Parts	66
Technical Support	67
Product Repair and Service	67
In Europe	68
Technical Support	68
Accessories and Parts	68

Worldwide Support 68

Appendix A: Specifications 69

Index 71

Chapter 1: Overview

1.1 Introduction

This handbook describes the DS600X Digital Fishfinder. The DS600X features state-of-the-art High Definition Fish Imaging (HDFI) technology. Constantly adjusting transmitter and receiver parameters throughout the water column, the DS600X intelligently analyzes fish and bottom echoes and automatically produces a crystal clear echo sounder display.

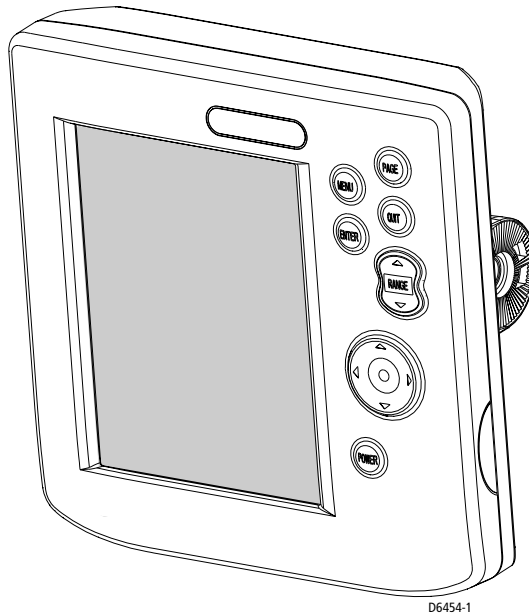

Figure 1-1: DS600X Digital Fishfinder

The DS600X employs a very high transmission repetition or “ping” rate which, along with the digital adaptive high sample rate receiver, ensures that fish and bottom structure are presented in superb detail and optimal color allocation. The DS600X digital bandwidth adaptation adjusts the receiver band width dynamically from very wide to very narrow, as required by the actual water conditions. This provides superior fish and bottom detection in all water conditions.

Features

- 5.7" Transmissive High Brightness TFT Color LCD
- ¼ VGA 76,800 Pixel Display Resolution
- Patented Digital HDFI Technology
- Hands-Off Adaptive Auto Adjustments
- Dual Frequency 200/50 kHz 500W RMS
- Depth/Temp/Speed transducer included with some models, which can measure water depth, water temperature and speed
- Speedometer-style digital data screen overlay
- NMEA 0183 compliant
- Easy Bracket or Flush mounting
- Waterproof to IPX7

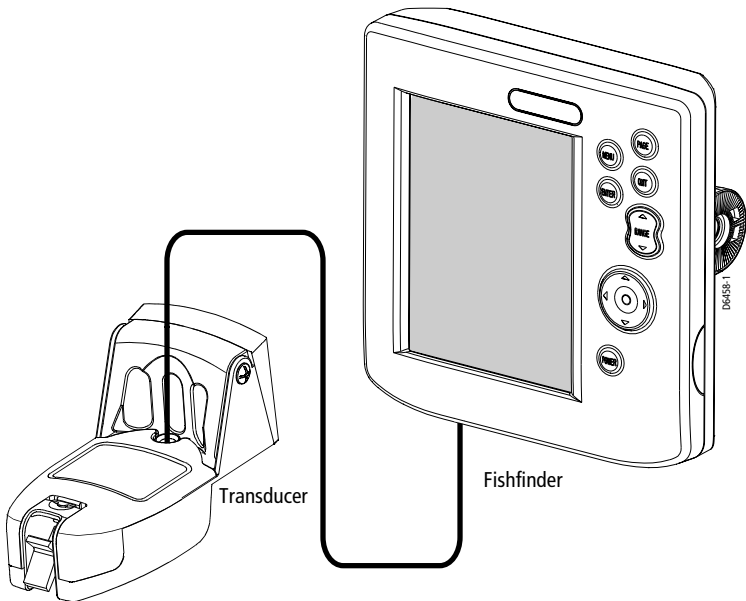

Figure 1-2: Basic Fishfinder System using the DS600X

General

The DS600X system, illustrated below, is comprised of the digital fishfinder, transducer and associated cables.

The DS600X is waterproof to IPX7 and can be installed either above or below deck.

The unit includes connections to:

- Power/NMEA
- the transducer

Transducer

The DS600X requires a transducer for measuring water depth, water temperature, distance traveled, and speed. A transducer is included with some fishfinder models. It is important to position your transducer correctly. Details on your transducer, including location and installation instructions, are included in the transducer box.

Chapter 2: Installation

2.1 Introduction

This chapter provides installation instructions for your DS600X.

Note: *If you wish to practice using the unit before installation, connect the power cable and use the simulator mode as described in Chapter 3. For power, connect a 12VDC power supply, attaching the red wire to positive and the black wire to negative. See Section 3.3 for details.*

2.2 Unpacking and Inspecting the Components

Unpack your system carefully, to prevent damage to the equipment. Save the carton and packing, in case you need to return a unit for service.

Check that you have all the correct system components. These depend on your system package, as follows:

Table 2-1: Supplied Parts

Item	Part No.
One of the following units:	
DS600X Digital Fishfinder without Transducer, US version	E63065
DS600X Digital Fishfinder without Transducer, CE version	E63066
Sun Cover	E32050
Mounting Bracket	E35005
Mounting Bracket Knobs	W145
Power/NMEA cable	R69074
Handbook, DS600X	81235
Mounting hardware	N/A

The following accessories are available for your A Series Fishfinder:

Table 2-2: Optional Accessories

Item	Part No.
Flush Mount Kit	E32051

Transducers are supplied with some models and optional with others. The following transducer options are available:

Table 2-3: Transducer Parts

Item	Part No.
Transducer Adapter Cable for L365/L470 Style Transducers	E66070
Transducer Adapter Cable for hsb ² /DSM250 Style Transducers	E66066
Transom Mount Transducer for DS400X/DS500X/DS600X (P58) ¹	E66062
Bronze Thru-hull Transducer for DS400X/DS500X/DS600X (B744V) ¹	E66061

¹supplied with some models

2.3 Selecting the Equipment Location

Mounting Location

The DS600X is waterproof to IPX7 is and designed to be mounted either above or below deck. The unit should be protected from physical damage and excessive vibration.

CAUTION:

Mount the DS600X in a protected area away from prolonged exposure to rain, salt spray, and direct sunlight, but well ventilated.

When planning the installation, the following should be considered to ensure reliable and trouble free operation:

- **Access:** There must be sufficient space below the unit to enable cable connections to the panel connectors, avoiding tight bends in the cable.
- **Interference:** The selected location should be far enough away from devices that may cause interference, such as motors, generators, and radio transmitter/receivers. (See the EMC guidelines in the Preface.)
- **Magnetic compass:** Mount the unit at least 3 ft (1m) away from a magnetic compass.
- **Cable runs:** The unit must be located near a DC power source. The power cable supplied is 5 ft (1.5 m), but a longer cable can be used if desired. Refer to *Section 2.4*.

The maximum length of cable between the fishfinder and the transducer unit should not normally exceed 25 ft (8 m).

- **Environment:** Good ventilation is required to prevent overheating.

**WARNING:**

Removing the transducer cable from the DS600X while power is turned on can cause sparks. As with any electronic device, be sure the fishfinder is mounted where it is well ventilated and free from gasoline fumes.

2.4 Cable Runs

Consider the following before installing the system cables:

- You will need to attach the power and transducer cables to the rear of the unit.
- All cables should be adequately secured, protected from physical damage and exposure to heat.
- Avoid running cables through bilges or doorways, or close to moving or hot objects.
- Avoid sharp bends.
- Where a cable passes through an exposed bulkhead or deckhead, use a watertight feed-through.
- Secure cables in place using tie-wraps or lacing twine. Coil any extra cable and tie it out of the way.

You will need to run the following cables:

- **Power/NMEA cable**, supplied with the unit. This 5 ft (1.5 m) cable has a connector plug at one end for connecting to the fishfinder, and 3 wires at the other end for connecting the power supply. The power cable may be extended by up to 60 ft (20 m) using a wire gauge of AWG 12 or greater. The DS600X is intended for use on the boat's DC power systems rated from 10-18 Volts DC (13.8V nominal).
- **Transducer cable**, supplied with the transducer. This 25 ft (8 m) cable has a connector plug at one end for the display unit.

Cutting the transducer cable will severely reduce sonar performance:

- **Do not cut the transducer cable or remove the connector.**
- **Do not shorten or splice the cable.**

If the transducer cable is cut, it must be replaced—it cannot be repaired. Cutting the cable will also void the warranty.

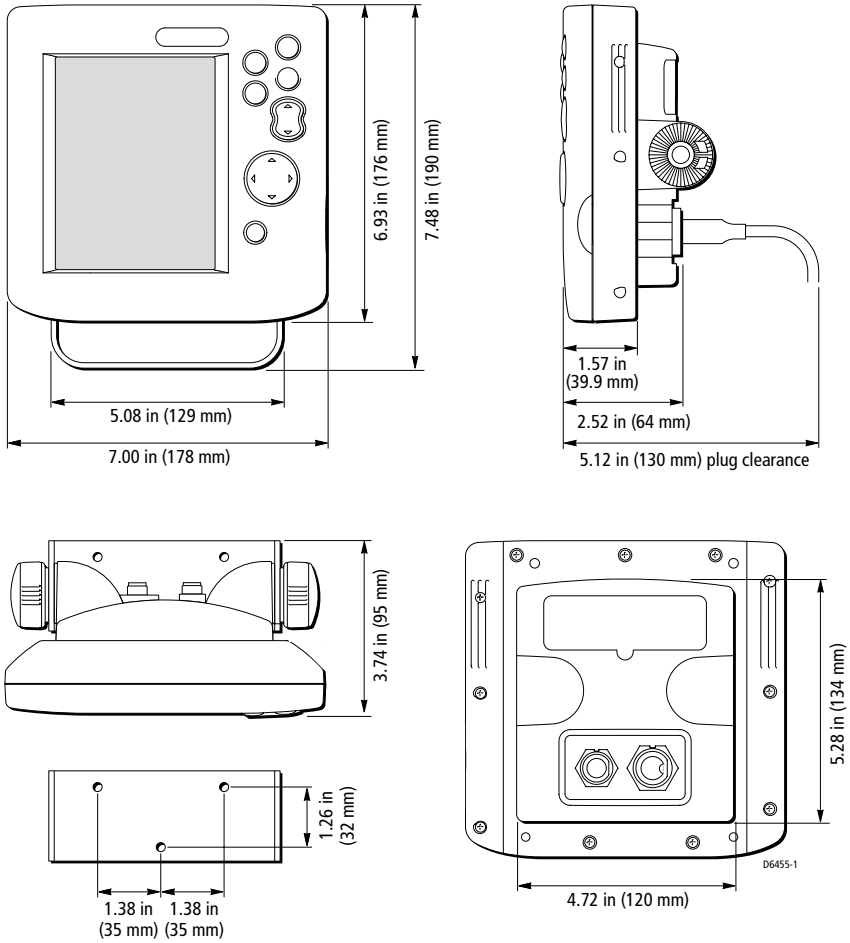

Figure 2-1: DS600X Unit Dimensions

2.5 Mounting the Fishfinder

The DS600X can be mounted on a dash, chart table, bulkhead or deckhead using the supplied hardware. The unit can also be flush mounted directly into the console.

Bracket Mounting

- ▶ To mount the DS600X on the supplied bracket:
 1. Loosen the knobs and remove the mounting bracket from the unit.
 2. Mark the locations of the mounting bracket screw holes on the mounting surface.
 3. Drill 5/16" (7 mm) holes through the mounting surface at the marked locations.
 4. Align the mounting bracket holes with the holes on the mounting surface.
 5. Use the screws and nuts supplied to attach the mounting bracket to the mounting surface at the marked locations.
 6. Attach the unit to the mounting bracket, adjust the display angle, and tighten the knobs.

Console Mounting (optional)

The fishfinder may also be installed directly into the console. This requires the purchase of an optional Flush Mount kit, Raymarine part number E32051.

- ▶ To flush mount the unit directly into the console using the optional kit:
 1. Make sure there are no hidden electrical wires or other items behind the location before proceeding. Make sure there is sufficient rear access for mounting and cabling.
 2. Check the selected location for the unit. A clear, flat area at least 7¼" (184 mm) wide by 7¼" (184 mm) high, with at least 3½" (89 mm) of clearance behind the panel, is required.
 3. Using the template supplied at the end of this handbook, trace out the unit opening and four mounting screw locations.
 4. Drill a ½ in (12.7 mm) pilot hole in each corner of the cut-out area.
 5. Using a suitable saw, cut along the inside edge of the cut-out line.
 6. Remove the mounting bracket knobs and bracket from the unit. Make sure that the unit fits in the cut-out area.
 7. Drill four 3/16" (5 mm) holes as indicated on the template.

8. Hand tighten the studs into the holes provided at the rear of the unit.
9. Place the gasket on the rear of the fishfinder.
10. Run the Power/NMEA cable and transducer cables through the back of the cutout and connect to the unit. Avoid tight bends in the cables.
11. Slide the unit into the panel cut-out.
12. Hand tighten the nuts to secure the unit to the console.
13. Alternatively, place a spacer over each of the four studs and secure with thumb nuts.

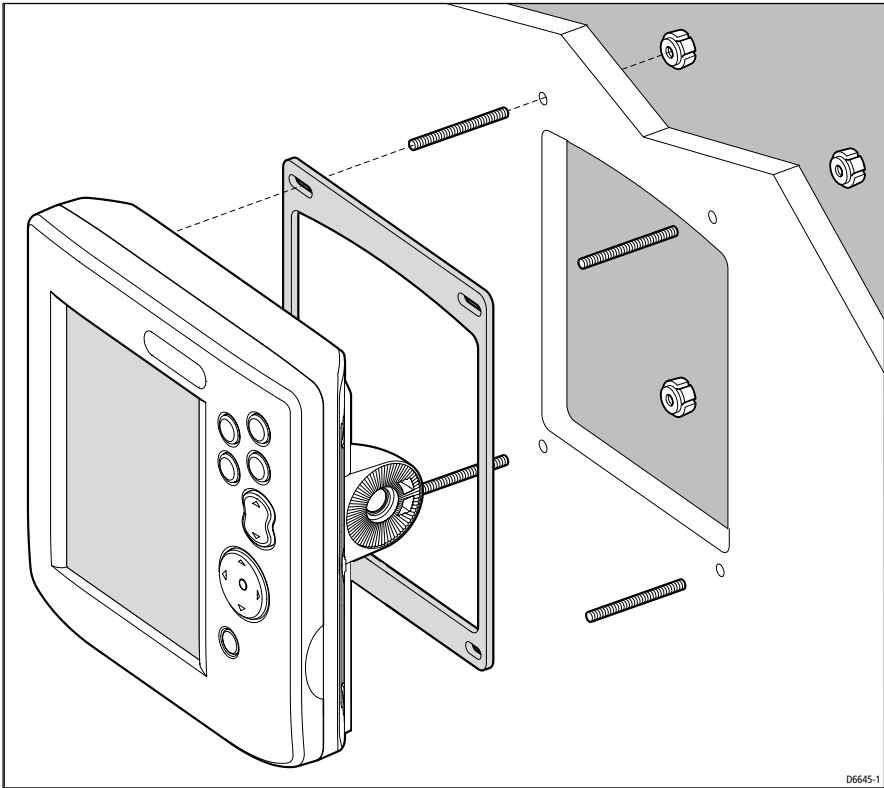

Figure 2-2: DS600X Flush Mounting Arrangement

D6645-1

2.6 System Connections

The rear of the fishfinder provides the following connection sockets:

- Power/NMEA
- Transducer

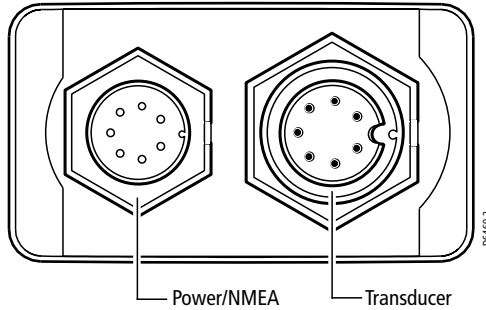

Figure 2-3: DS600X Connector Panel

DC Power and NMEA Connection

The DS600X is intended for use on boat’s DC power systems rated from 10-18 Volts DC (13.8V nominal).

A 5 ft (1.5 m) cable is supplied for connecting the boat’s DC power and NMEA interface to the unit. This Power/NMEA cable can be extended by up to 60 ft (20 m) using a wire gauge of AWG 12 or greater.

The cable’s molded end attaches to the seven-pin Power/NMEA connector on the unit’s connector panel.

The cable connector (viewed from the outside) is shown in the following drawing.

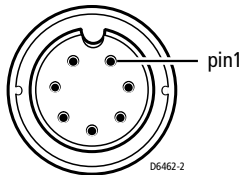

Figure 2-4: Power Cable Connector

The exposed wires on the open end of the cable should be connected as follows:

Pin No.	Function	Color
1	Battery negative –	Black
2	Battery positive + (10.0VDC to 18.0VDC)	Red
3	NMEA Input +	White
4	NMEA Input –	Green
5	CGND	Gray
6	NMEA Output +	Yellow
7	NMEA Output –	Brown

The red wire connects to the feed from the positive (+) battery terminal and the black wire connects to the feed from the negative (–) battery terminal. The shield wire (drain) connects to the boat’s RF ground. If your boat does not have an RF system, you can trim off the drain wire.

A fast blow 2 amp fuse is attached (in-line) to the red (positive) wire.

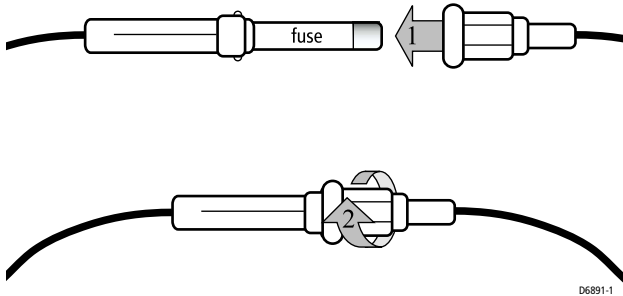

Figure 2-5: Installing the Fuse

CAUTION:

If the power connections are accidentally reversed the system will not work. Use a multimeter to ensure that the input power leads are connected for correct polarity.

Transducer Connection

A 25ft (8m) cable is supplied with the transducer. The transducer cable connector has a nut that has been removed to aid installation. To enable you to complete the installation without cutting the cable, ensure that any holes you drill are large enough to accept the connector, with the nut removed (approximately 13/16" or 21 mm).

Before attaching the transducer cable, you will need to attach the connector nut, which is included in the transducer packaging.

The transducer cable is attached to the 7 pin male TRANSDUCER connector on the connector panel of the DS600X. (See *Figure 2-3*.)

CAUTION:

- Do not pull on the cable. This can damage the transducer wires.
- Do not cut the transducer cable or remove the connector.
- Do not try to shorten or splice the cable. Cutting the transducer cable will severely reduce sonar performance.
- If the cable is cut, it must be replaced—it cannot be repaired. Cutting the cable will also void the warranty.



WARNING:

Removing the transducer cable from the rear of the DS600X while the fishfinder is powered on can cause sparks. Only remove the transducer cable after power has been removed from the DS600X.

If the transducer cable is accidentally removed while the DS600X is powered on, remove power from the fishfinder, replace the transducer cable, and then restore power. As a safety feature, the DS600X only recognizes that the transducer is connected at power-up.

Chapter 3: Getting Started

3.1 Introduction

This chapter provides basic instructions to get you started using the DS600X Digital Fishfinder. It describes Simulator mode and can help you to become familiar with the basic functions of the fishfinder's operation controls. More detailed information on using the menu items and display controls is provided in *Chapter 4* and *Chapter 5*, respectively.

3.2 Powering on the Fishfinder



Connect the power cord to boat's power source and plug into the power port on the connector panel. Press the **POWER** button on the DS600X.

Details on setting up your DS600X and display are given in *Chapter 6*.

3.3 Simulator Mode

If you have not fully installed the fishfinder, you can still operate in Simulator mode by connecting the fishfinder to a 12VDC power supply.

Figure 3-1 demonstrates how to setup the DS600X for Simulator mode. Attach the red wire from the power lead to positive (+) and the black wire to negative (-).

When you power up the DS600X without connecting the transducer, the unit enters Demo mode. This provides a preprogrammed demonstration highlighting the fishfinder's main features. This function enables you to practice operating the fishfinder without data from the transducer, using simulated data.

If the transducer is connected, you can enter Simulator Mode by following instructions outlined on *page 62*.

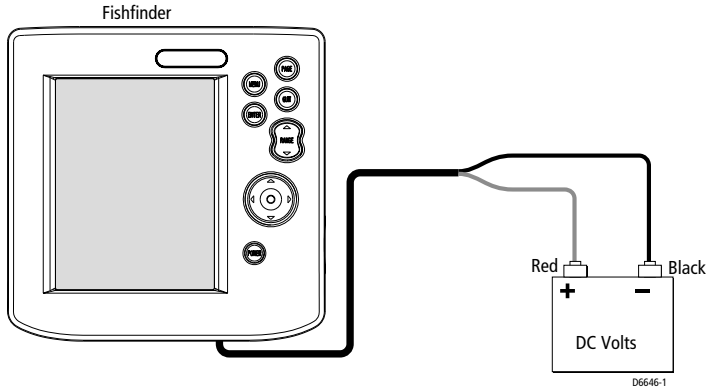

Figure 3-1: Demo/Simulator Mode Setup

3.4 LCD Display

When you first switch on the fishfinder, the scrolling bottom graph, or Fishfinder Page, is displayed. This is a graphical representation of the echoes seen by the DS600X. As time passes, this display scrolls from right to left and becomes a record of the echoes seen. A typical display is shown in *Figure 3-2*.

The images at the right hand side of the display are the most recent echoes. Some echoes indicate fish, and others show the bottom. It can also indicate bottom structures, such as a reef or shipwreck. The upper and lower depth range limits are shown.

You can customize the sounder by choosing what is displayed and how it is displayed (including language and units). For example, you can set whether the bottom graph display scrolls and you can select the range to adjust the depth displayed.

You can view the cursor position and a variety of data (such as speed and depth) from the transducer and other equipment in user-selectable data boxes. These data boxes can be moved around the screen and they can be switched on or off.

Chapter 5 includes details on adjusting the display, other set up options are described in *Chapter 6*.

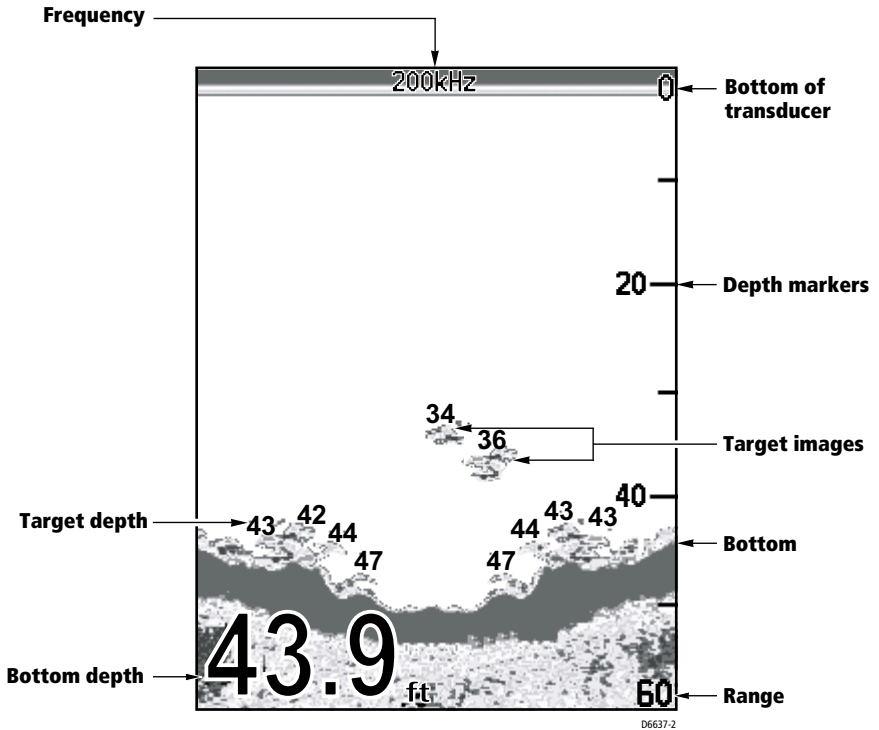

Figure 3-2: Typical Fishfinder Display Screen

3.5 Interpreting the Sounder Image

The DS600X uses sound waves to find fish and show bottom structure. The transducer sends sound waves into the water; these sound waves strike fish, the bottom, or other objects in the water and return as echoes. The DS600X interprets these echoes to present an image of the fish and bottom.

The strength of echoes is indicated by different colors. You can use this information to determine the size of fish and the bottom structure. Other objects in the water, such as debris and air bubbles, also return echoes; these echoes are generally weaker than the fish or bottom echoes and produce background noise or *clutter* on the display. The digital sounder provides controls to reduce the background noise and to adjust the way in which echoes of different strengths are displayed.

Target Indications

When the sounder detects a target echo such as a fish, it displays a representative image on the LCD. The shape and size of this image is influenced by a combination of factors:

Boat speed

The shape of the target changes along with your speed. Slower speeds return flatter, more horizontal images. As your boat's speed increases, the image will tend to thicken and arch slightly.

The depth of the target

The closer the target to the surface the larger the image on screen.

To display the depth of individual targets, switch on the TARGET DEPTH ID from the menu, as described on *page 44*.

The size of the target

The larger the target, the larger the return on the fishfinder display. The size of a fish target is however dependent upon the size of the fish's swim bladder rather than its overall size. This swim bladder will vary in size between different breeds of fish.

The frequency of the transducer

The same target will appear differently when the transducer frequency is changed. Generally, the lower the frequency the broader the image.

3.6 Keypad Operation

The DS600X has seven control keys.

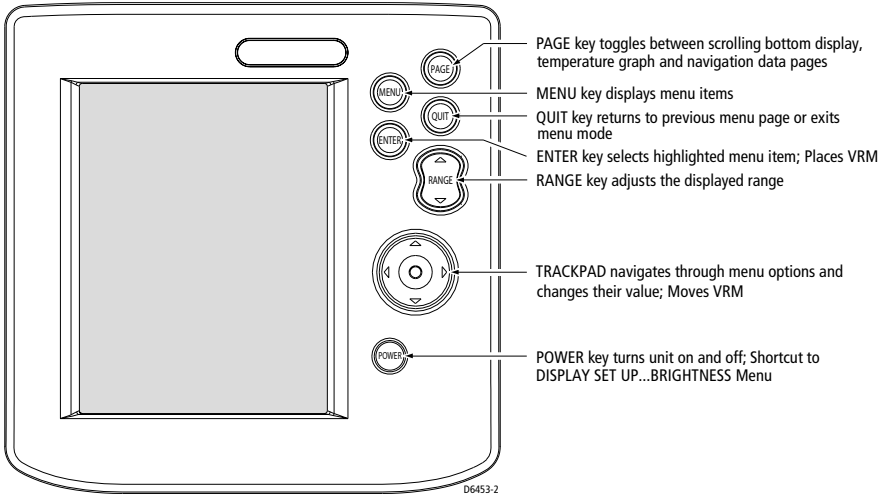

Figure 3-3: Keypad Functions



PAGE

Press this key to display a data page containing Temperature Graph over time, Boat Speed, Boat Battery Voltage, Log and Trip Distances and Depth.

Press again to display Navigation data: Lat/Lon, Speed Over Ground (SOG), Course Over Ground (COG), Waypoint location, Range and Bearing and Time of day. This information is only available if the fishfinder is connected via NMEA to another device outputting navigation data.

Press again to return to the Fishfinder Page, or scrolling bottom graph display.



MENU

Press this key to enter Main Menu setup mode.



QUIT

Press this key to back up one menu level. If already at the first menu level, this exits Menu mode.



ENTER

Pressing this key when a Menu box is displayed selects the menu item currently highlighted. When no Menu box is open, this key places the Variable Range Marker (VRM).



RANGE

Press the ∇ arrow key to increase displayed range (deeper) and press the \wedge arrow key to decrease it (shallower).

TRACKPAD (\wedge and ∇)



When a Menu databox is displayed, use the up and down arrow keys to move the selection bar (item currently highlighted) up and down the list.

When in Zoom mode, use these keys to move the zoom area up or down on the display.

TRACKPAD (\ll and \gg)

When a Menu item has more than one possible response, use the left and right keys to change the value.

When a menu item appears in UPPER CASE, it contains sub-menus. Press the right arrow or **ENTER** to access the sub-menu items.

When the VRM is displayed, use the right and left arrow keys to change the VRM's position on the screen.



POWER

Press to turn on the fishfinder. Press and hold for three seconds to turn unit off.

Press and release as a shortcut to the DISPLAY SET UP... Brightness setting.

3.7 Using the Variable Range Marker (VRM)

The VRM (Variable Range Marker) key is used to determine the distance behind the boat of an object on the display. The VRM function is available on the scrolling sonar display and zoom windows, if your transducer is equipped with a paddlewheel for measuring speed and distance.



To display the VRM, press **ENTER** from the main fishfinder page. The VRM is displayed as a vertical line running the entire height of the display. You can use the $<$ and $>$ keys of the trackpad to move the VRM over a particular object to reference it from the boat.



Distance behind the boat is displayed next to the vertical line. The VRM distance units correspond to the depth units assigned in the system set up parameters you have assigned for your unit. However, when set to fathoms, the VRM is displayed in feet.

The vertical line does not scroll with the scrolling sonar image. If the display range changes, the VRM retains its position. When you switch on the VRM, it is displayed at its last position.



Press **QUIT** to remove VRM from the screen.

If the sounder is in split frequency display mode, the VRM is shown in only one window at a time.

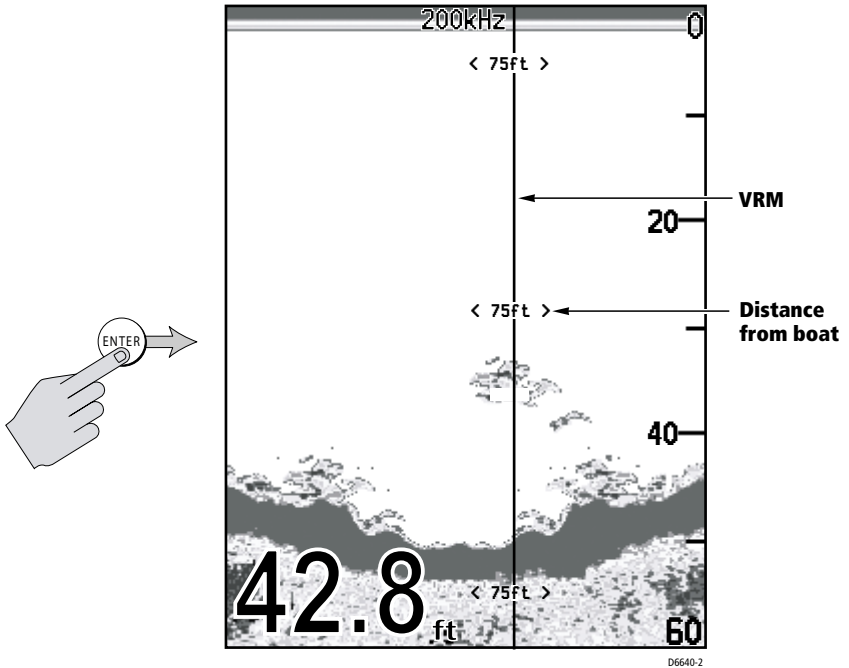

Figure 3-4: Using VRM

3.8 Selecting the Display Page

The DS600X Fishfinder provides you with three Display Pages for presenting information.

- Fishfinder Page
Displays sounder data. This is the default screen; it appears when you first power on the unit.
- Temperature Graph Page
Displays a graph plotting water temperature readings from the transducer over the past 60 minutes as well as current water temperature, boat speed and a trip log.

- Navigation Data Page
Displays position (if connected via NMEA) and current time, date, water temperature, battery voltage and depth information.



➤ To change Display Pages:

Press the **PAGE** key.

Each key press advances the Page screen.

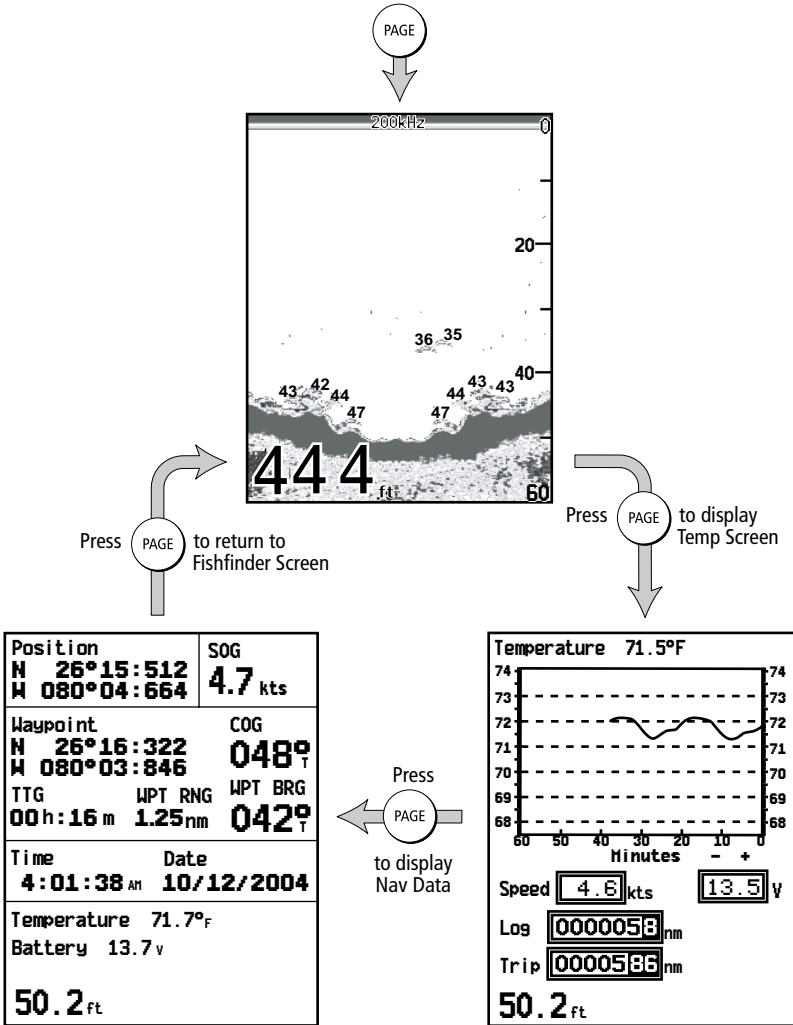

Figure 3-5: Display Pages

3.9 Menu Operation

DS600X Fishfinder Page functions can be accessed using the controls that are displayed when you press the **MENU** key. The Main Menu is displayed. These function control:

- General Fishfinder Operations
- Display Control Functions
- Sounder Setup Functions

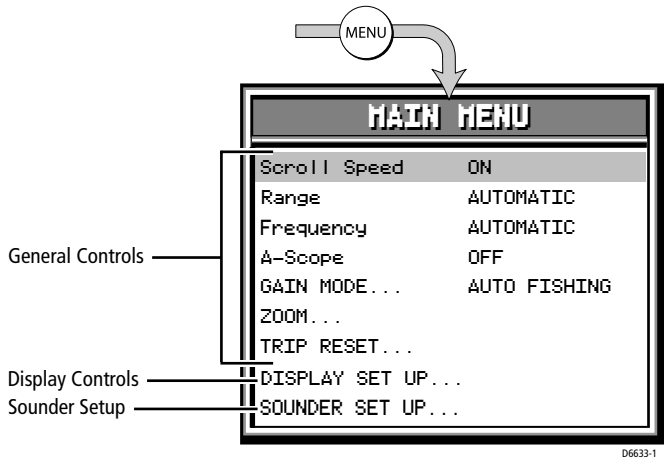
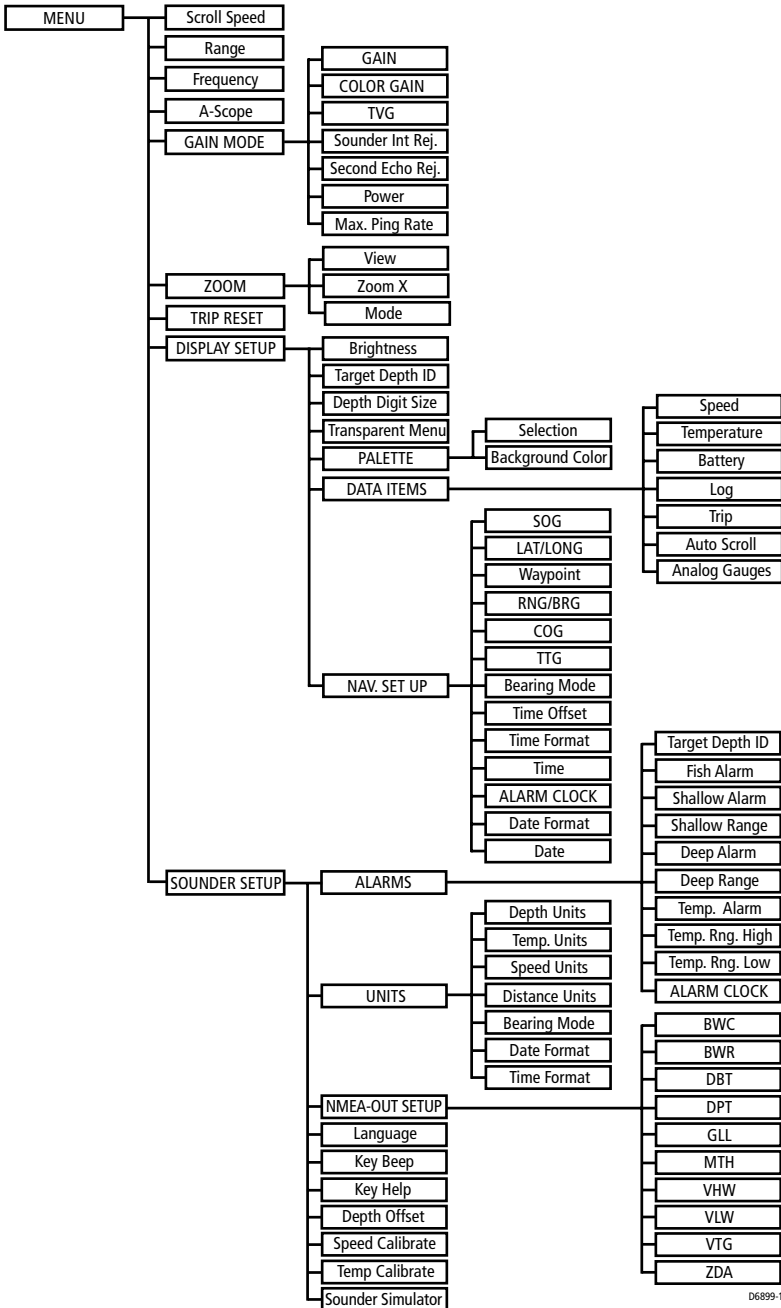

Figure 3-6: Accessing the Main Menu

Figure 3-6 identifies these groupings. General Menu Controls are described in Chapter 4. Display Setup functions are described in Chapter 5. Sounder Setup functions are described in Chapter 6.

Menu Structure

Following is a diagram of the A Series Fishfinder menu structure.



Chapter 4: Main Menu

4.1 Introduction

This chapter provides basic menu functions for using the DS600X Digital Fishfinder. More detailed information on using the Display controls and sounder setup is provided in *Chapter 5* and *Chapter 6*, respectively.

Selecting MENU Items

This section provides an example of how to browse through the Main Menu by demonstrating how to make a change to the Gain setting.

► To make changes to the menu settings:

1. Press the **MENU** key. The MAIN MENU screen appears. The currently-selected menu item (in this case, Scroll Speed) is highlighted.

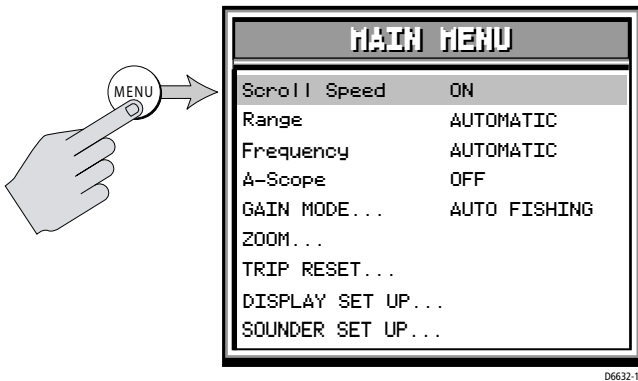

2. Press the \wedge or \vee trackpad keys to browse to GAIN MODE... Continue holding the key down to scroll at a faster rate. GAIN MODE... contains sub-menu items you can change. All menu items that have sub-menus are shown with all capital letters followed by an ellipsis (...).

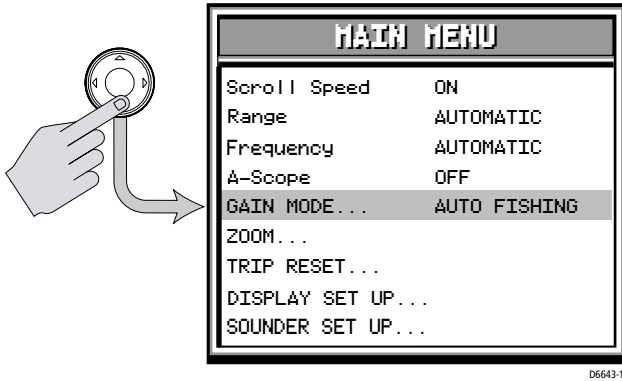

- 3. Press the trackpad > key or **ENTER** to browse the sub-menus.

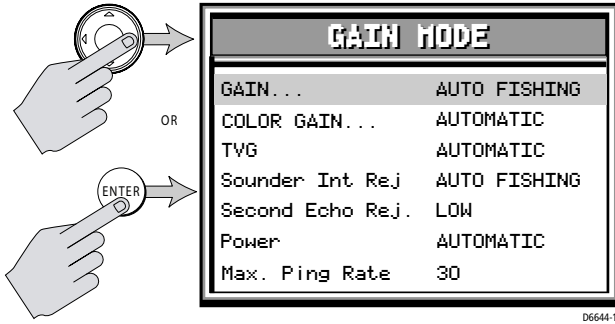

- 4. To edit the highlighted menu item, press the trackpad < or > keys to scroll through the available options. Once the item is changed, the change is accepted; you need not use the **ENTER** key to select.

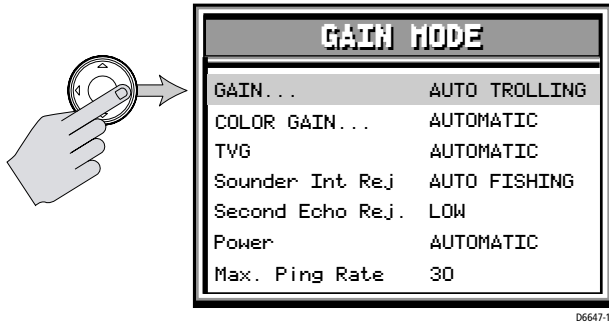

- 5. For some numerical settings you will press the **ENTER** key to select and then use the trackpad to increment or decrement the value.
For example, to change a manual setting:
 - i. Use the trackpad to browse to **MANUAL**.
 - ii. Press **ENTER** to accept. The **MANUAL** field is no longer highlighted.
 - iii. Use the trackpad to increment/decrement the value.
 - iv. Press **ENTER** again to accept. The **MANUAL** field is again highlighted.

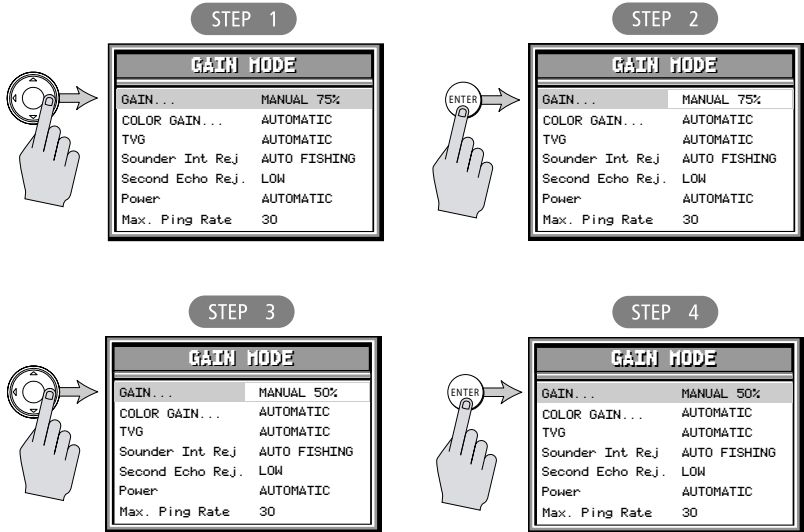

- 6. Press the **QUIT** key to exit. If you are currently in a sub-menu, pressing **QUIT** will return you to the previous page. You may have to press **QUIT** more than once to exit the Menu screen completely and return to the fish-finder page.

- 7. If enabled in the SOUNDER SET UP... menu, the Key Help function displays tips on which keys to press to make your menu selections. Key Help appears at the bottom of the screen, adjacent to the depth reading. See *Key Help* on page 61.

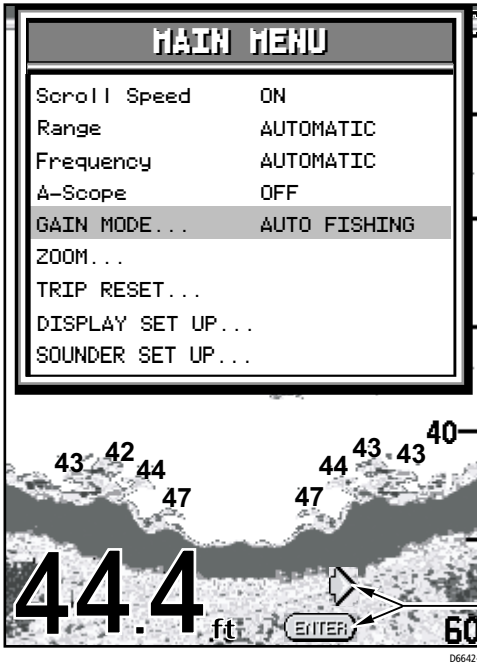

ARROW and ENTER key-help symbols prompting you to use Trackpad and ENTER keys to change this menu item.

Note: Menu items that are displayed in all caps followed by an ellipsis (GAIN MODE..., for example) contains sub-menus. Use the trackpad keys to scroll through the sub-menus.

4.2 Fishfinder Operation Controls

The fishfinder operation menu items are outlined in *Table 4-1*.

Table 4-1: Fishfinder Menu Items

Menu	Sub-Menu	Options	Default
Scroll Speed	—	ON, PAUSED	ON
Range	—	AUTOMATIC, MANUAL	AUTOMATIC
Frequency	—	AUTOMATIC, 200 kHz MAN, 50 kHz MAN, DUAL MAN	AUTOMATIC
A-Scope	—	OFF, ON-1, ON-2, ON-3	OFF
GAIN MODE...	GAIN	AUTO FISHING, AUTO TROLLING, AUTO CRUISING, MANUAL (0–99%)	AUTO FISHING
	COLOR GAIN	AUTOMATIC, MANUAL (0–99%)	AUTOMATIC
	TVG (Time Variable Gain)	AUTOMATIC, MANUAL (0–100%)	AUTOMATIC
.	Sounder Int. Rej.	AUTOMATIC, LOW, HIGH	AUTOMATIC
	Second Echo Rej.	OFF, LOW, HIGH	LOW
	Power	AUTOMATIC, MANUAL (10–100% in 10% increments)	AUTOMATIC
	Max. Ping Rate	5–30, in increments of 1	30

Menu	Sub-Menu	Options	Default
ZOOM...	View	OFF, SPLIT, FULL SCREEN	OFF
	Zoom X	X2, X3, X4	X2
	Mode	AUTOMATIC, MANUAL	AUTOMATIC
TRIP RESET...	—	QUIT = no ENTER = yes	—
DISPLAY SET UP...	(See <i>Chapter 5</i> .)		
SOUNDER SET UP...	(See <i>Chapter 6</i> .)		

Scroll Speed

This menu item enables you to start and stop the bottom graph display from moving across the screen.

- ON starts the bottom graph display.
- PAUSED stops the bottom graph display.

Note: *The PAUSED setting doesn't stop sonar pinging. Digital depth continues to be calculated while scrolling is paused.*

The default is ON.

Range

By default, the sounder automatically adjusts the display range, selecting the shallowest range that keeps the bottom in the lower half of the display window. Alternatively, the Range setting enables you to select the maximum depth displayed on the scrolling bottom and A-Scope displays.

This parameter determines whether the depth range displayed is set automatically by the sounder or manually using the **RANGE** key.

- AUTOMATIC for the sounder to determine the range as dictated by the current depth.
- Select MANUAL to enable the **RANGE** key for setting the range.

If you press the **RANGE** key to manually set the range while the automatic setting is enabled displays, the fishfinder displays the following message:

The range mode must be set to **MANUAL** before the range will change. Press **UP**, **DOWN**, or **MENU**.

Pressing **^** or **v** on the **RANGE** key or pressing the **MENU** key opens the Range field in the **MAIN MENU** so you can make the change if desired. If you wish to remain in Automatic Range mode, press **QUIT**.

The following range/shift values are available:

Table 4-2: Range Values

Feet	Fathoms	Meters (CE models only)
5	1	2
10	2	4
15	3	6
20	4	8
30	6	10
40	8	15
50	10	20
60	15	25
80	20	30
100	25	40
150	30	50
200	40	60
250	50	80
300	60	100
400	80	150
600	100	200
800	150	300
1000	200	400
1500	250	500
2000	300	600

The default setting is **AUTOMATIC**.

Frequency

The DS600X uses dual frequency sonar—50 kHz and 200 kHz—and can be used in either auto or manual modes.

The DS600X can automatically select the appropriate frequency, based on the current display range. As the depth increases while in Auto Frequency mode, the fishfinder shifts from 200 kHz to 50 kHz. As the depth decreases, the fishfinder switches from 50 kHz to 200 kHz.

You can select the transducer frequency for automatic or manual operation at 50 kHz, 200 kHz or both frequencies simultaneously.

- **AUTOMATIC** enables the digital fishfinder to determine the optimum frequency based on the current conditions.
- **200 kHz MAN** fixes the frequency at 200kHz no matter what depth you are viewing. This frequency is typically used for shallower water and a more detailed view. When using this frequency, the transducer scans a narrower area, but produces a more detailed view. The 200 kHz signal is good for finding fish near the bottom or close together. It is better for use in shallow water.
- **50 kHz MAN** fixes the frequency at 50kHz no matter the depth. This frequency is typically used for wide coverage and deep water. When using this frequency, the transducer scans a wide area. The 50 kHz signal penetrates water well, so is good for use in deep water.
- **DUAL MAN** displays separate screens for both 50 and 200kHz. The transducer can operate in both 50 kHz and 200 kHz frequencies at the same time. If you choose dual frequency operation, the scrolling bottom display is split vertically; the left half shows the 200 kHz detailed view and the right half shows the 50 kHz image.

The default setting is **AUTOMATIC**.

A-Scope

Use the A-Scope screen to show raw sonar data directly from the transducer beam. This gives you a “real time” image of fish and bottom structure directly below the transducer. This function is very useful in showing the strength of the echo returned from a fish. The display is split vertically, with the A-Scope image in the right hand window and the scrolling bottom image in the left hand window.

Select one of the three modes for A-Scope, as demonstrated in *Figure 4-1* :

- OFF, in which A-Scope does not appear.
- ON-1, in which the image takes up the entire A-Scope window.
- ON-2, in which only the left side of the image displayed in Mode ON-1 expands to the entire A-Scope window. This mode provides the greatest resolution.
- ON-3, in which the A-Scope image is angled outward as the signal width (indicated with dotted lines) increases with depth.

The default setting is OFF.

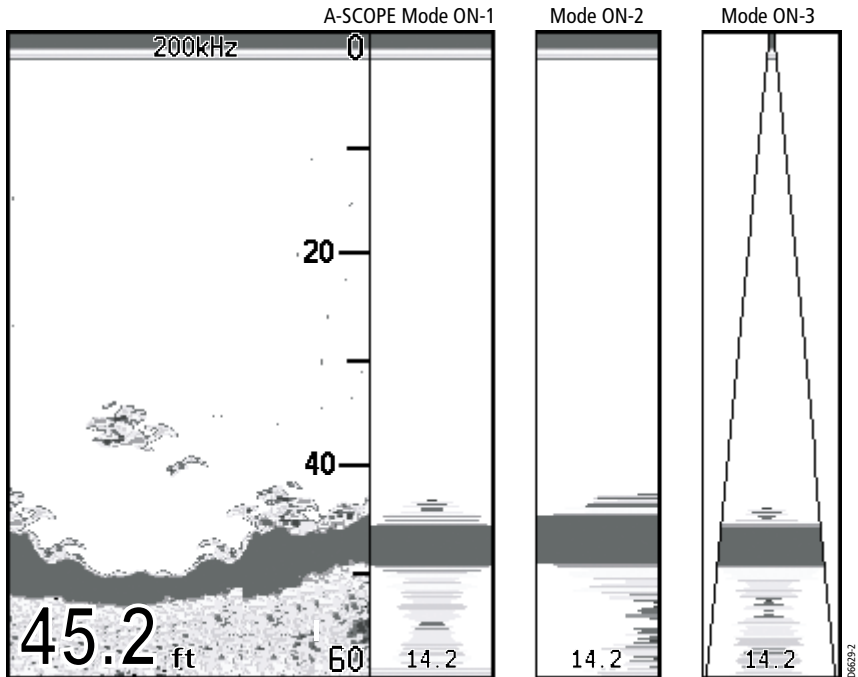

Figure 4-1: The Three Modes of A-Scope

GAIN MODE...

The sounder provides GAIN controls to reduce background noise and determine how different strength echoes are shown. Automatic adjustment of each of these parameters is available or you can manually adjust the settings using the trackpad.

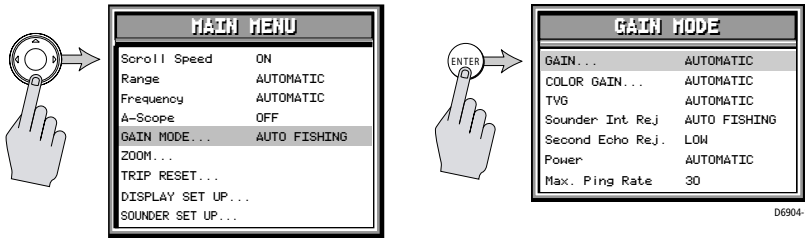

Figure 4-2: Accessing GAIN Mode

Note: *Automatic Gain settings take advantage of the hardware's advanced digital technology. As a result, the sounder typically performs better in automatic mode than manual. For better performance Raymarine recommends selecting AUTO mode for all Gain options.*

Note that this menu item is in all caps and is followed by an ellipsis (...). This is an indicator that the setting contains sub-menus. Gain Mode is comprised of seven sub-menus.

- Gain
- Color Gain
- Time Variable Gain (TVG)
- Sounder Interference Rejection (Int. Rej.)
- Second Echo Rejection
- Power
- Maximum Ping Rate

Use the trackpad to scroll through the sub-menu items.

► To set a Manual Gain value in any of the following sub-menus:

1. Use the trackpad to highlight **MANUAL**.
2. Press **ENTER**. Normal (not highlighted) text appears.
3. Press the **^** or **>** Trackpad key to increment and the **∨** or **<** Trackpad key to decrement the Gain setting.
4. Press **ENTER** to accept the **MANUAL** value.

GAIN

The gain, or sensitivity, of the display adjusts background noise by varying echo strength for display. The value of the gain control determines the strength above which echoes are displayed. If the gain is low only the strongest echoes are displayed. As the gain is increased, weaker echoes (from air bubbles, for example) are also displayed.

The automatic gain modes find the ideal sensitivity level for you, based on depth and water conditions. Automatic gain modes take advantage of the hardware's advanced HDFI technology. As a result, the sounder typically achieves a sharper image in any of the automatic gain modes than is possible in manual mode. Automatic gain varies the gain throughout the water column based on the current conditions.

The DS600X provides three pre-defined automatic gain settings:

- **AUTO FISHING** is the highest automatic gain setting. It gives the best details of the targets you have located and is ideal for slow speeds and drifting.
- **AUTO TROLLING** is a medium gain setting that is better suited for trolling speeds.
- **AUTO CRUISING** is the lowest automatic gain setting, ideal for reducing background noise or travelling to your fishing spot at high speeds.
- **MANUAL** gain should be set high enough to see fish and bottom detail but without too much background noise. Generally, a high gain is used in deep and/or clear water; a low gain in shallow and/or murky water.

The default setting is **AUTO FISHING**.

Color Gain

Color Gain determines how echoes of different strengths are displayed. 128 colors per palette are available, with the strongest signals displayed in colors representing the strongest signals in the currently-selected palette. The Color Gain control sets the lower limit (threshold) for the strongest signal and is represented as a percentage of that strongest signal.

A lower Color Gain percentage means a stronger echo is required to be displayed in the strongest signal colors. All echoes with a signal strength above this value are displayed in darker colors. All echoes weaker than this value are divided equally between the remaining colors.

Your choices are:

- **AUTOMATIC:** Displays colors based on current conditions (with as many colors as possible) while minimizing noise and clutter. As conditions change the auto-color gain adjusts.
- **MANUAL:** Setting a low value produces a wide band for the weakest colors but a small signal band for the other colors; setting a high value gives a wide band for the strongest colors but a small signal band for the other colors. If you select manual adjustment, you will need to re-adjust the gain as conditions change.

The default setting is AUTOMATIC.

Time Variable Gain (TVG)

TVG (Time Variable Gain) reduces clutter by varying the gain throughout the water column. This function is useful for reducing “noise” that can appear. Increasing the TVG value increases the maximum depth to which TVG is applied. Decreasing reduces the maximum depth.

Although you can manually set the TVG level, Raymarine recommends letting the unit choose the proper level for you by selecting AUTOMATIC.

The default setting is AUTOMATIC.

Sounder Interference Rejection (Int. Rej.)

Two or more sonar-equipped vessels operating within range of each other can interfere with sounder operation. This usually appears as vertical streaks on the display that do not represent actual targets.

This option can reduce such interference, either manually or automatically.

- **AUTOMATIC** selects the best rejection level for you
- **LOW** minimizes rejection of potential interference. Use this setting when you want to be sure that what has been removed are really false returns.
- **HIGH** rejects much more interference but can potentially weaken the appearance of actual targets.

The default setting is AUTOMATIC.

Second Echo Rejection

A so-called “second echo” can be caused by the sonar signal returning from the bottom, reflecting off the water’s surface, bouncing off the bottom again and returning. This option helps eliminate identifying a false bottom.

Select from the following:

- OFF, which offers no rejection
- LOW, which provides minimal rejection by slightly reducing the ping rate
- HIGH, which offers the greatest signal rejection by decreasing the ping rate further

The default setting is LOW. Only set this setting to HIGH if you notice second echoes appear on your display.

Power

The Power setting provides adjustment of the transducer signal. Select from the following:

- AUTOMATIC, in which the sounder automatically determines the optimal power setting based on the current depth, speed, and (bottom) signal strength
- MANUAL, in which the power is increased or decreased in 10% increments.

The default setting is AUTOMATIC.

Max. Ping Rate

The setting determines the maximum number of sonar pulses, or pings, the transducer emits per second. You can set Max Ping Rate anywhere between 5–30, in increments of 1.

The default setting is 30 pings per second, the maximum. You can reduce this number down to a minimum of 5 pings per second, if necessary, to help reduce second echoes.

ZOOM...

Zoom enlarges all or part of the scrolling bottom display at x2, x3 or x4 magnification. You can select automatic zoom so the sounder keeps the bottom in the lower portion of the zoom window or manually pick the area to be zoomed. The ZOOM sub-menus are:

- View
- Zoom magnification
- Zoom Mode

View

The View sub-menu determines how the zoomed area appears on the screen.

- OFF means the display is not zoomed.
- SPLIT means the display is split vertically, with the zoom image in the left hand window and the scrolling bottom display in the right hand window. See *Figure 4-3*.

In a split window display, a zoom box appears, representing the range being displayed in the zoom window. The depths of the upper and lower boundaries of the zoom box are displayed in the upper and lower right corners of the zoom window.

- FULL SCREEN zooms the entire screen.

Note: *If also displaying dual frequencies, the zoomed image is displayed fully in both frequency windows.*

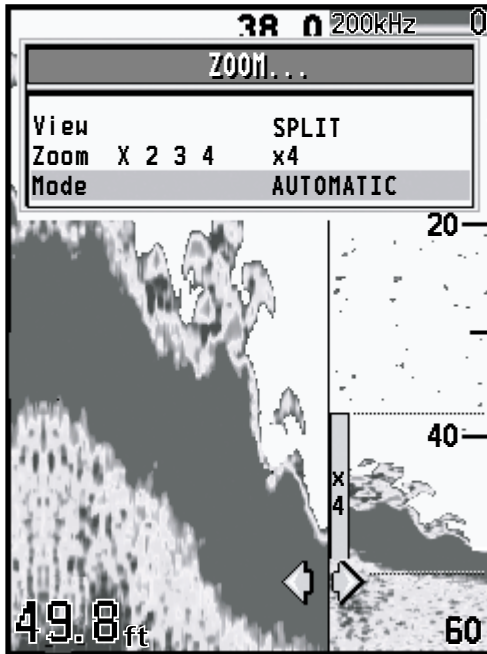

Figure 4-3: Zoom with Split Screen

Zoom x2, x3, x4 Magnification

This parameter sets the level of display magnification. The greater the zoom, the smaller the area you are viewing, so the smaller the Zoom Range Bar.

Select from:

- x2
- x3
- x4

Mode

- **AUTOMATIC** adjusts the position of the zoom window so that bottom details are always in view.
- **MANUAL** enables you to reposition the zoomed image.

TRIP RESET...

This option resets the trip log. Once TRIP RESET is selected you have the option to press:

- **QUIT** to exit without resetting
- **ENTER** to confirm the reset.

DISPLAY SET UP...

These settings determine how information is displayed on the screen. Options are described in *Chapter 5*.

SOUNDER SET UP...

These setup parameters are described in *Chapter 6*.

Chapter 5: Display Set Up

5.1 Introduction

This chapter will help you to become familiar with the functions of the display's controls. A general discussion of the fishfinder's menu items was provided in *Chapter 4*. Information on setting up the sounder is provided in *Chapter 6*.

The Display Set Up menu items affect how data appears on the screen. In most cases, you will only need to use these options when you first set up your system. As you become more familiar with your system, you may decide to customize some aspects.

► To access the Display Set Up menu items:

1. Press the **MENU** key. The Main Menu appears.
 2. Press the \wedge or \vee trackpad keys to navigate to DISPLAY SET UP...
 3. Press the trackpad $>$ key or **ENTER** to select.
 4. Press the \wedge or \vee trackpad keys to browse to the desired Display Menu item.
 5. Press the trackpad $<$ or $>$ keys to select the desired option.
For menu items with sub-menu items (menu title in all CAPITALS...), press the trackpad $>$ key or **ENTER** to browse the sub-menus.
 6. Press **QUIT** to exit when finished.
- Figure 5-1* also demonstrates how to access the Display Set Up menu items. A description of how to browse the menu and make selections is outlined in *Selecting MENU Items* on page 25.
- Note:** You can also access the DISPLAY SET UP... Brightness menu by pressing and releasing the **POWER** key.

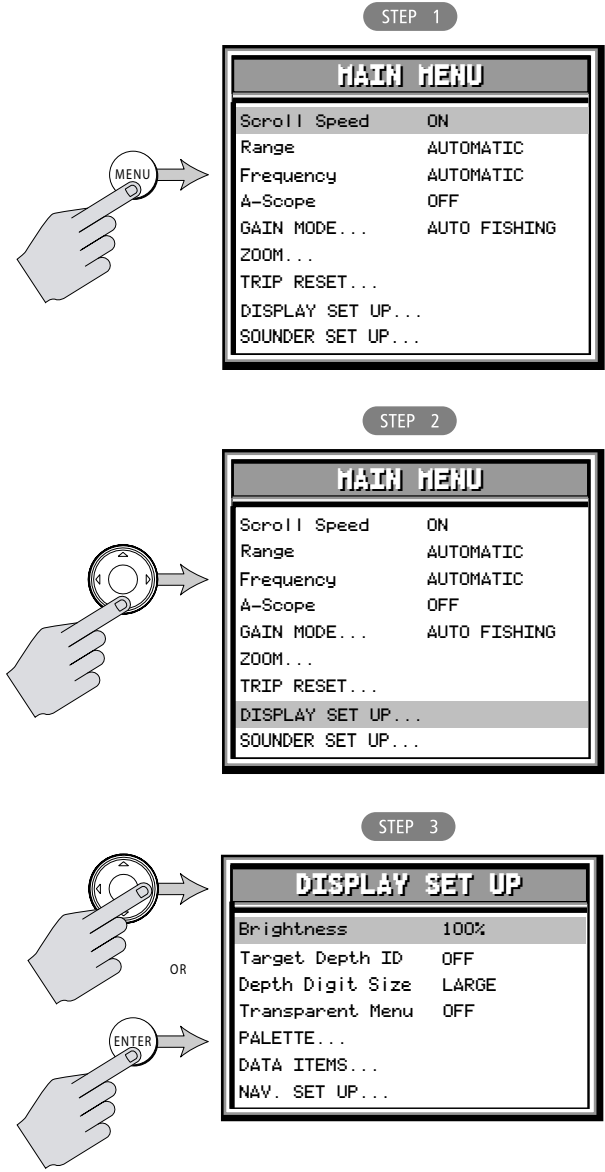

Figure 5-1: Accessing Display Set Up Menu Items

The Display Set Up menu items are listed in *Table 5-1* and then described following that.

Table 5-1: DISPLAY SET UP... Menu

Menu	Sub Menu	Options	Default
Brightness	—	10–100% in 10% increments	100% (Note: never powers up at less than 40%)
Target Depth ID	—	OFF, DEPTH, FISH, FISH & DEPTH	OFF
Depth Digit Size	—	LARGE, SMALL	LARGE
Transparent Menu	—	OFF, ON	OFF
PALETTE...	Selection	CLASSIC, SUNBURST, GRAYSCALE, INV. GRAY, COPPER, NIGHT VISION	CLASSIC
	Background Color	WHITE, BLACK, BLUE	WHITE
DATA ITEMS...	Speed Temperature Battery Log Trip Auto Scroll Analog Gauges	OFF, ON	OFF
NAV. SET UP...	SOG	OFF, ON	OFF (Note: not displayed if Analog Gauges ON)
	LAT/LONG	OFF, ON	OFF
	Waypoint	OFF, ON	OFF
	RNG/BRG	OFF, ON	OFF

Menu	Sub Menu	Options	Default
	COG	ON, OFF	OFF
	TTG	OFF, ON	OFF
	Bearing Mode	TRUE, MAGNETIC	TRUE
	Time Offset	UTC, -13 to +13 hours	UTC
	Time Format	12 HOUR, 24 HOUR	12 HOUR
	Time	OFF, ON	OFF
	ALARM CLOCK	OFF, ON	OFF
	Date Format	MM/DD/YY, DD/MM/YY	MM/DD/YY
	Date	OFF, ON	OFF

Brightness

Use the trackpad < and > keys to select the brightness value from a low of 10% to a high of 100%. Each trackpad key press changes the value in 10% increments. The default is 100%.

Note: *This setting will never be less than 40% at power up.*

Target Depth ID

You can select whether the depth or a fish icon is shown for sonar echoes displayed on the screen.

- OFF displays neither the depth or a fish icon. This is the default setting.
- DEPTH displays the depth just above each target echo.
- FISH displays a fish icon instead of an echo. Three different fish icons appear, representing the size of the target detected: small, medium and large.
- FISH & DEPTH displays both the depth and a fish icon.

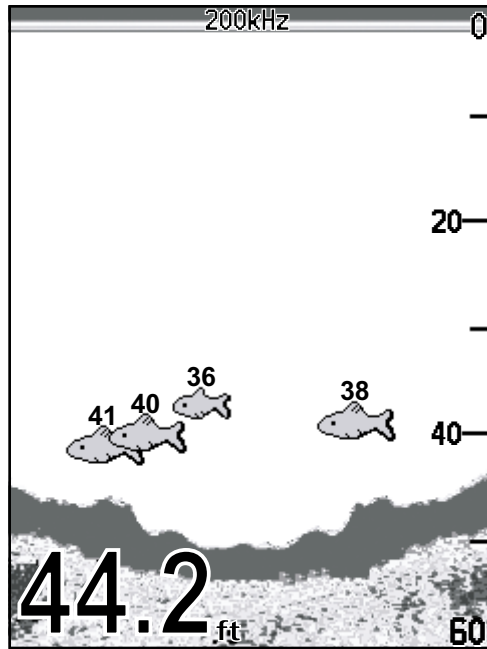

Figure 5-2: FISH & DEPTH Target Depth IDs

Depth Digit Size

This setting controls the size of the digital depth readout at the lower left of the screen. Choose from the following:

- LARGE (default)
- SMALL

Transparent Menu

This option removes the background white from the menu dialog box, enabling you to see data that would normally be hidden.

- OFF selects a normal opaque Menu box, which is the default setting.
- ON selects the transparent Menu box.

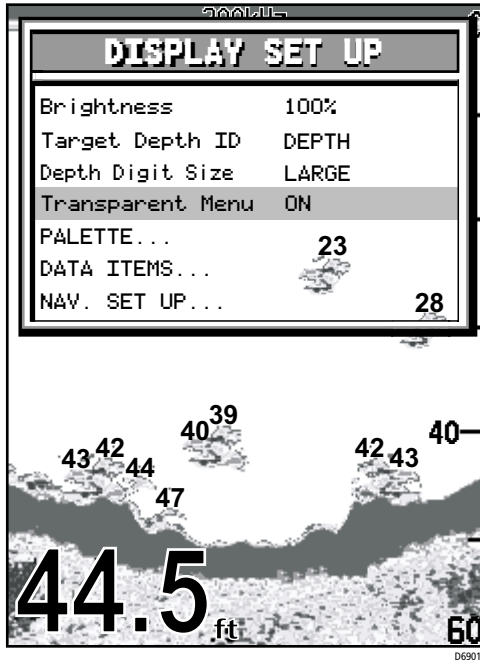

Figure 5-3: Transparent Menu

PALETTE...

The DS600X offers you six different display color combinations. You can select the color set, for a bold or soft color palette. The brightness of the screen can be adjusted over a wide range, suitable for viewing in daylight (high brightness level) or at night (low brightness level).

Selection

Select the optimal color scheme for your lighting conditions:

- CLASSIC (default)
- SUNBURST
- GRAYSCALE
- INV. GRAY
- COPPER
- NIGHT VISION

Background Color

When the CLASSIC palette is selected, you can also choose the background color used. Three colors are available for the sonar display background – black, white and blue.

You will probably find that you need to change the background color in different light conditions. For example, a white background is probably easiest to see in bright sunlight, but a black background may be preferable at night.

Select from the following:

- WHITE (default)
- BLACK
- BLUE

DATA ITEMS...

Data Items provide regularly-used data in a compact form so that most of the graphics can still be seen. Each data item can be displayed in a separate data field or scrolled through a single data field every three seconds.

Select ON or OFF for each item. The default is OFF.

- **Speed**
Reading from transducer's paddlewheel.
- **Temperature**
Reading from transducer's temperature-sensing thermistor.
- **Battery**
The boat's battery voltage.
- **Log**
Total distance travelled by the boat.
- **Trip**
Distance travelled since the counter was reset.
- **Auto Scroll**
Scrolls each data item that has been turned ON one-at-a time in the upper left corner of the screen every three seconds.
- **Analog Gauges**
Presents data items that have been turned ON as analog gauges rather than in digital format.

Note: When analog gauges are selected, the Navigation Items cannot be displayed on the Fishfinder page. You must switch to the Nav Data page using the PAGE key to view that information.

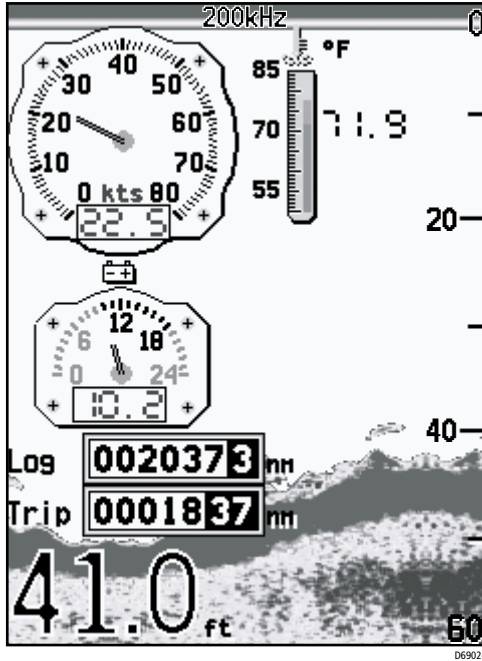

Figure 5-4: Data Items Displayed as Analog Gauges

NAV. SET UP... (Navigation Data)

Similar to Data Items, this is a list of navigation data you can display on the screen as separate data items. Select from the following:

- **SOG**
Speed Over Ground
Display ON or OFF
- **LAT/LONG**
Latitude and Longitude position of your boat
Display ON or OFF
- **Waypoint**
Latitude and longitude position of waypoint
Display ON or OFF

- **RNG/BRG**
Range and bearing of waypoint
Display ON or OFF
- **COG**
Course Over Ground
Display ON or OFF
- **TTG**
Time to Go before reaching waypoint, at current course and speed
Display ON or OFF
- **Bearing Mode**
The mode of all the bearing and heading data displayed.
Select TRUE or MAGNETIC
- **Time Offset**
Number of hours to offset the displayed time from the Universal Time Constant (UTC), otherwise known as Greenwich Mean Time.
Select UTC time or from +13 to -13 hours of UTC.
- **Time Format**
Display 12 HOUR or 24 HOUR
- **Time**
Display ON or OFF
- **ALARM CLOCK**
OFF or ON
- **Date Format**
Display MM/DD/YY or DD/MM/YY
- **Date**
Display ON or OFF

Note: *When analog gauges are selected as Data Items, the Navigation Items cannot be displayed on the Fishfinder page. You must switch to the Nav Data page using the PAGE key to view this information.*

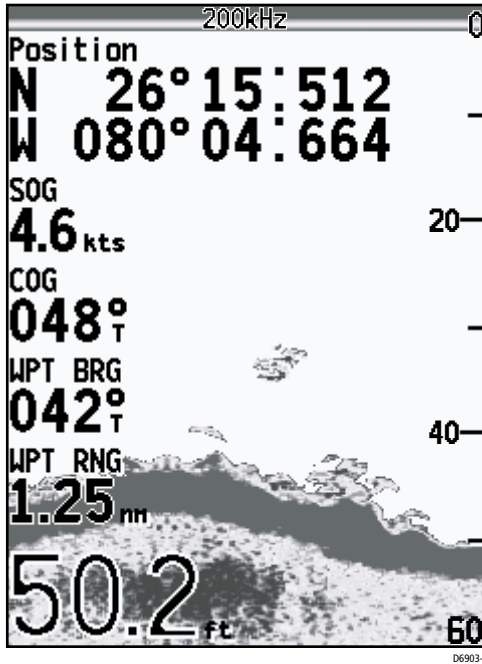

Figure 5-5: Displaying Navigation Data

Chapter 6: Sounder Set Up

6.1 Introduction

Once you have installed your DS600X and are familiar with its basic operation, you need to set it up so that it displays information according to your preferences. The **SYSTEM SET UP** option enables you to set up your system configuration and personal preferences.

In most cases, you will only need to use these options when you first set up your system. As you become more familiar with your system, you may decide to customize some aspects, such as the Alarms and Offset and Calibrate settings.

In most cases, you will only need to use the Sounder Setup options when you first set up your system. As you become more familiar with your system, you may decide to customize some aspects. At the end are displayed the serial number of your sounder and the software version running. This information may be requested by Raymarine staff should technical support become necessary.

► To access the Sounder Set Up menu items:

1. Press the **MENU** key. The Main Menu appears.
2. Press the \wedge or \vee trackpad keys to navigate to **SOUNDER SET UP...**
3. Press the trackpad $>$ key or **ENTER** to select.
4. Press the \wedge or \vee trackpad keys to browse to the desired menu item.
5. Press the trackpad $<$ or $>$ keys to select the desired option.
For menu items with sub-menu items (menu title in all CAPITALS...), press the trackpad $>$ key or **ENTER** to browse the sub-menus.
6. Press **QUIT** to exit when finished.

Figure 6-1 also demonstrates how to access the Sounder Set Up Menu Items. A description of how to browse the menu and make selections is outlined in *Selecting MENU Items* on page 25.

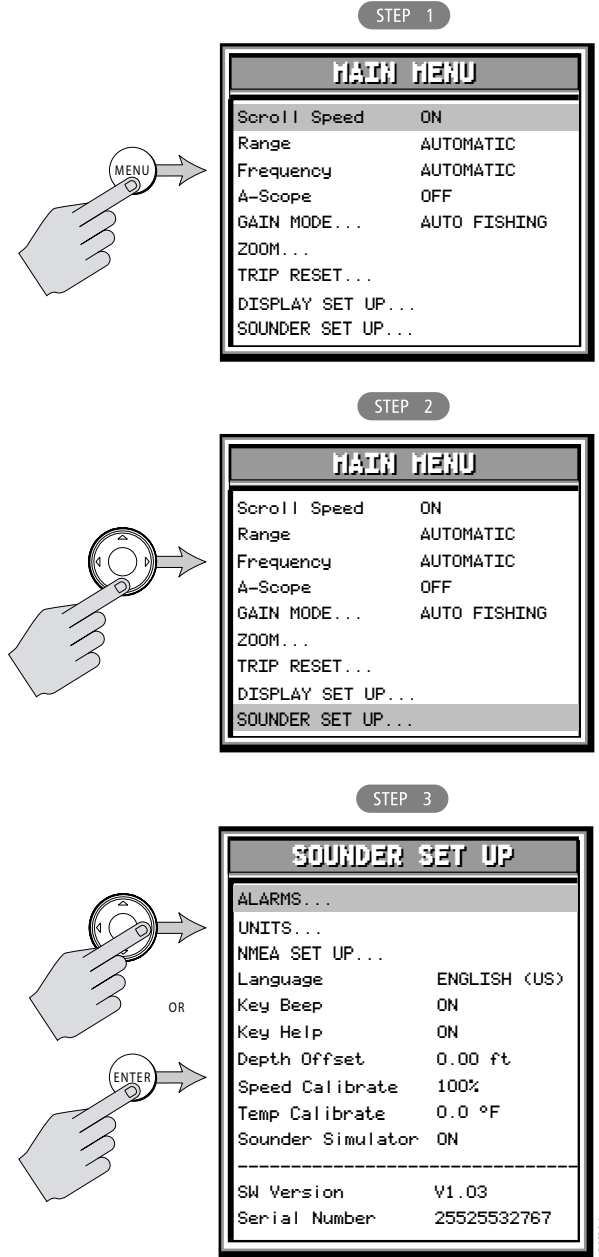

09639-1

Figure 6-1: Accessing Sounder Set Up Menu Items

The following table lists the setup menus and their options and shows the factory default setting. Each parameter is described in the following subsections.

Table 6-1: SOUNDER SET UP... Menu Items

Menu	Sub-Menu	Options	Default
ALARMS...	Target Depth ID	OFF, DEPTH, FISH, FISH & DEPTH	OFF
	Fish Alarm	ON, OFF	OFF
	Shallow Alarm	ON, OFF	OFF
	Shallow Range	2 – 1999 FEET, 0 – 332 FATHOMS, 1 – 608 METERS ¹	5 FEET, 1 FATHOM, 2 METERS ¹
	Deep Alarm	ON, OFF	OFF
	Deep Range	3 – 2000 FEET, 1 – 333 FATHOMS, 1 – 609 METERS ¹	1500 FEET, 250 FATHOMS, 457 METERS ¹
	Temp. Alarm	OFF, ON	OFF
	Temp. Rng. High	99.9 °F, 37.7°C	75°F, 23.9°C
	Temp. Rng. Low	-9.9 °F, -23.2°C	60°F, 15.6°C
	ALARM CLOCK...	OFF, ON	OFF
UNITS...	Depth Units	FEET, FATHOMS, METERS ¹	FEET
	Temp. Units	FAHRENHEIT, CENTIGRADE	FAHRENHEIT

Menu	Sub-Menu	Options	Default
	Speed Units	KNOTS, MILES PER HOUR, KM PER HOUR	KNOTS
	Distance Units	NAUTICAL MILES, STATUTE MILES, KILO METERS ¹ , KILO YARDS	NAUTICAL MILES
	Bearing Mode	TRUE, MAGNETIC	TRUE
	Date Format	MM/DD/YY, DD/MM/YY	MM/DD/YY
	Time Format	12 HOUR, 24 HOUR	12 HOUR
NMEA-OUT SETUP	BWC BWR DBT DPT GLL MTW VHW VLW VTG ZDA	OFF, ON	OFF
Language	—	ENGLISH (UK), ENGLISH (US), DANISH, FRENCH, GERMAN, DUTCH, ICELANDIC, ITALIAN, NOWEGIAN, PORTUGUESE, SPANISH, SWEDISH, FINNISH	ENGLISH (US)
Key Beep	—	ON, OFF	ON
Key Help	—	ON, OFF	ON

Menu	Sub-Menu	Options	Default
Depth Offset	—	-9.9 to +9.9 FEET, -1.7 to +1.7 FATHOMS, -3.0 to +3.0 METERS ¹	0
Speed Calibrate	—	1% to 200% in 1% increments	100%
Temp Calibrate	—	-5.0 to +5.0°C -9.0 to +9.0°F	0°
Sounder Simulator	—	OFF, ON	OFF when transducer connected ON when transducer not connected

¹METERS settings only available in CE models

ALARMS...

This menu group is used to set up alarms that are available to alert you of certain conditions. Each alarm can be toggled ON and OFF and you set the threshold at which the alarms are triggered, except for the fish and battery voltage alarms.

Alarms consist of an audible tone and moving arrows pointing to the data display for that particular item. When an alarm is activated, press a key to mute the tone. The visual indicator continues as long as the condition exists.

You may want to use the shallow and deep water alarms when you are anchored. Set the limits to just above and below your anchor depth; the sounder triggers an alarm if the anchor drags and the boats moves into shallower or deeper water.

Note: *After you have acknowledged the sounding of a shallow or deep water alarm, a minimum of 30 seconds must elapse before a another shallow/deep alarm can sound again. However, the visual indicator will continue as long as the condition exists.*

Target Depth ID

You can select whether the depth or a fish icon is shown for sonar echoes displayed on the screen. The default setting is OFF.

- OFF displays neither the depth or a fish icon.
- DEPTH displays the depth just above each target echo.
- FISH displays a fish icon in place of each echo.
- FISH & DEPTH displays both the depth and a fish icon.

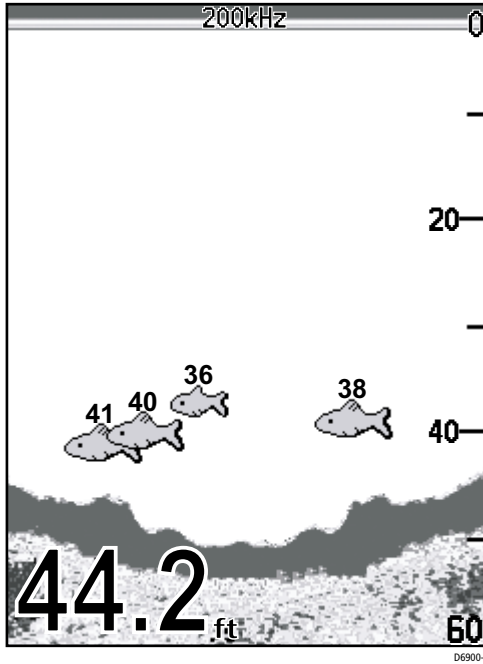

Figure 6-2: FISH & DEPTH Target Depth IDs

Fish Alarm

If this alarm is ON, the unit sounds a beeper whenever it finds a fish. The default setting is OFF.

Shallow Alarm

If this alarm is ON and the depth below the boat is less than the value set using the **Shallow Range** setting, the beeper sounds and moving arrow indicators point to the digital depth display. You cannot set the shallow alarm to be deeper than the deep alarm. The default setting is OFF.

Shallow Range

Use the < and > trackpad keys to decrement/increment the depth at which the Shallow Alarm will sound. The depth units are dependent on the value set using the *UNITS...* parameter. (See page 59.) Changing the value set for Shallow Range automatically enables the Shallow Alarm.

Deep Alarm

If this alarm is ON and the depth below the boat is greater than the value set using the **Deep Range** setting, the beeper sounds and moving arrow indicators point to the digital depth display. You cannot set the deep alarm to be shallower than the shallow alarm. The default setting is OFF.

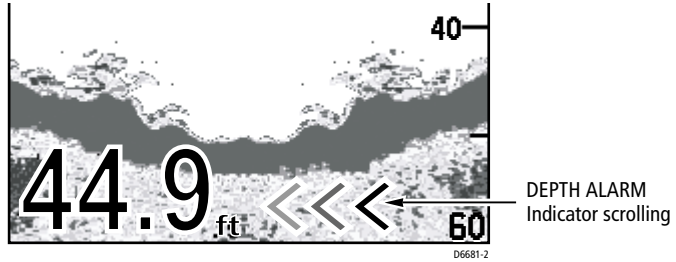

Figure 6-3: Shallow/Deep Alarm Condition

Deep Range

Use the < and > trackpad keys to decrement/increment the depth at which the Deep Alarm will sound. The depth units are dependent on the value set using the *UNITS...* parameter. (See page 59.) Changing the value set for Deep Range automatically enables the Deep Alarm.

Temp. Alarm

If this alarm is ON and the water temperature falls within the range set using the **Temp. Rng. High** and **Temp. Rng. Low** settings, the beeper sounds and moving arrow indicators point to the temperature display. In an alarm condition, the temperature display appears even if this data item has been set OFF. (See *DATA ITEMS...* on page 47.) The temperature alarm also activates if the temperature moves outside the set range. If data items are displayed as analog gauges when the alarm is active, the temperature value flashes.

You cannot set the **Temp. Rng. High** setting to be lower than **Temp. Rng. Low** and vice-versa. The default setting is OFF.

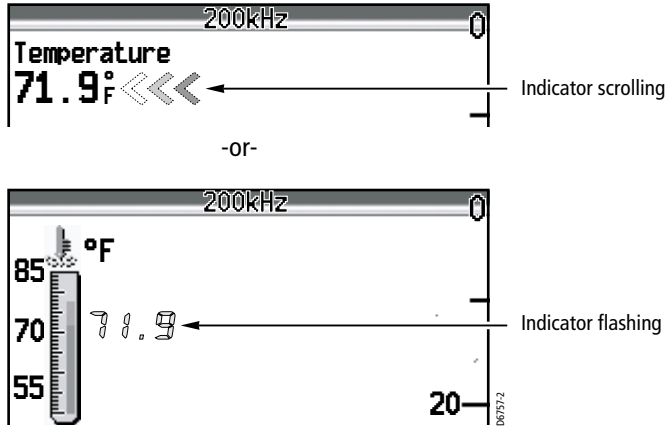

Figure 6-4: Temperature Alarm with Standard & Analog Gauges

Temp. Rng. High

Use the < and > trackpad keys to decrement/increment the highest temperature at which the Temp Alarm will sound. The temperature units are dependent on the value set using the *UNITS...* parameter. (See page 59.)

Temp. Rng. Low

Use the < and > trackpad keys to decrement/increment the lowest temperature at which the Temp Alarm will sound. The temperature units are dependent on the value set using the *UNITS...* parameter. (See page 59.)

ALARM CLOCK...

Set this alarm to sound the beeper at a particular time of day.

Note: *This function requires NMEA input of the current time.*

► To enable the Alarm Clock:

1. Select (highlight) ALARM CLOCK.
2. Press the < or > trackpad key to change the setting from OFF to ON. The word ON and the alarm time are highlighted.
3. Press **ENTER**. The word ON and the time are no longer highlighted.
4. Press the < or > trackpad key to decrement/increment the alarm time.
5. When the time at which you want the alarm to sound is displayed, press **ENTER** again. The word ON and the time are highlighted again. The alarm is set.

6. When the alarm clock sounds, it is accompanied by a message box labeled ALARM CLOCK displaying the time.

The default setting is OFF.



Figure 6-5: Alarm Clock

UNITS...

You can set the units for each system parameter. The units you set will be used to display all data, including information received from other instruments on the system.

Depth Units

- FEET (default)
- FATHOMS
- METERS (Available in CE models only)

Temp. Units

- FAHRENHEIT (default)
- CENTIGRADE

Speed Units

- KNOTS (default)
- MILES PER HOUR
- KM PER HOUR

Distance Units

- NAUTICAL MILES (default)
- STATUTE MILES
- KILO METERS

Note: VRM distance is measured by the transducer's paddlewheel and is based on the Depth units you have set. If Depth is set in feet or fathoms, Distance is displayed in feet. If Depth is set in meters, Distance is also set in meters. (METERS settings are only available in CE models.)

Bearing Mode

- TRUE (default)
- MAGNETIC

Date Format

- MM/DD/YY (default)
- DD/MM/YY

Time Format

- 12 HOUR (default)
- 24 HOUR

NMEA-OUT SET UP...

This option lets you disable the transmission of specific NMEA sentences, which may be necessary if you have other instruments sending the same data as your sounder.

The factory default for all NMEA sentences is transmission ON. Disable the sentence by selecting OFF.

The following table displays the available NMEA sentences and their meanings.

Table 6-2: NMEA Sentences

Sentence	Meaning
BWC	Bearing & Distance to Waypoint ¹
BWR	Bearing & Distance to Waypoint – Rhumb Line ¹
DBT	Depth Below Transducer
DPT	Depth
GLL	Geographic Position – Latitude/Longitude ¹
MTW	Water Temperature
VHW	Water Speed and Heading
VLW	Distance Travelled through the Water
VTG	Course Over Ground and Ground Speed ¹
ZDA	Time and Date ¹

¹Data repeated from external device

Language

Select the language in which you wish information to be displayed. The selected language will be used for all screen text. Select from the following:

- ENGLISH (UK)
- ENGLISH (US) (default)
- DANISH
- FRENCH
- GERMAN
- DUTCH
- ICELANDIC
- ITALIAN
- NORWEGIAN
- PORTUGUESE
- SPANISH
- SWEDISH
- FINNISH

Key Beep

When set ON, the keys sound a tone when you press them.

Key Help

When Help is set to ON, icons appear next to the digital depth display, prompting you to make the appropriate key presses. The help message is cleared when an action is selected.

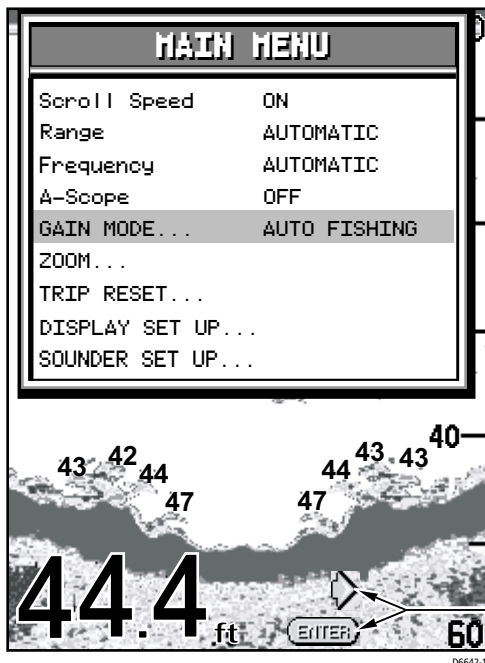

ARROW and ENTER key-help symbols prompting you to use Trackpad and ENTER keys to change this menu item.

Depth Offset

The depth offset is added to the measured depth value before it is displayed. You can specify the depth as a positive value (waterline offset) or a negative value (keel offset). The depth offset can be adjusted in 0.1 increments of the units you have assigned using the *UNITS...* parameter. (See page 59.)

Speed Calibrate

If the transducer is equipped with a speed paddlewheel, the DS600X calculates the speed of the boat through the water. The Speed Calibrate option enables you to adjust the displayed speed so that it matches your actual speed through the water. You can adjust the displayed speed from 1% to 200%.

If the sounder reading is too low, set Speed Calibration to more than 100%. If the sounder reading is too high, set Speed Calibration to less than 100%. This setting also calibrates the Log, Trip and paddlewheel distance.

Temp Calibrate

If the transducer is equipped with a temperature-sensing thermistor, the DS600X calculates the temperature of the water. The temperature calibrate option enables you to adjust the displayed temperature in 0.1 degree increments of the temperature units you have assigned using the *UNITS...* parameter. (See page 59.)

Sounder Simulator

The simulator enables you to operate your display without data from the transducer, in order to become familiar with the sounder features and functions. You can set the simulator ON or OFF. You cannot select OFF when the unit is powered on without a transducer connected.

SW Version and Serial Number (read only)

The area at the bottom of the Sounder Setup screen gives version information for the system. This area is informational only; it is not editable.

SW Version displays the software version of the DS600X.

Serial Number displays the serial number of the DS600X, which should also be marked on the label on the rear of the unit.

Chapter 7: Maintenance and Problem Solving

This chapter provides information on routine maintenance and on possible causes of problems you may experience with your DS600X.

7.1 Maintenance



CAUTION:

This unit contains *high voltage*. Adjustments require specialized service procedures and tools only available to qualified service technicians - there are no user serviceable parts or adjustments and the operator should not attempt to service the equipment. *The operator should not remove the rear cover of the module.*

Routine Checks

The DS600X is a sealed unit. Maintenance procedures are therefore limited to the following periodic checks:

- Examine the cables for signs of damage, such as chafing, cuts or nicks.
- Check that the cable connectors are firmly attached.

Cleaning Instructions

Cleaning the Unit

The DS600X is a sealed unit and does not require regular cleaning. However, if you find it necessary to clean the unit, please follow these basic procedures:

- Ensure power is off.
- Wipe the module clean with a damp cloth.
- If necessary, use IPA (isopropyl alcohol) or a mild detergent solution to remove grease marks.

Cleaning the Transducer

Sea growth can collect quickly on the bottom of the transducer, this can reduce the performance in just a few weeks. To prevent the build-up of sea growth, coat the transducer with a thin layer of paint.

Use only a water-based antifouling paint, or a water-based paint specifically designed for transducers. Apply the paint with a brush.

If your transducer becomes fouled or stops working because of sand or sea growth, use a stiff brush to clean it. You may sand the surface with a fine-grit wet or dry sandpaper (#320 grade or finer), but this will affect the performance of the unit when the boat is moving at higher speeds.

The paddlewheel mechanism may become jammed by dirt, grit or barnacles. Work the contaminant out of the mechanism, then clean the unit with soap and water or alcohol.

Cleaning the Hull

Use caution when sanding or cleaning the outside of the hull near the transducer.

CAUTION:

Harsh cleaning solvents such as acetone may damage the transducer.

EMC Servicing and Safety Guidelines

- Raymarine equipment should be serviced only by authorized Raymarine service technicians. They will ensure that service procedures and replacement parts used will not affect performance. There are no user serviceable parts in any Raymarine product.
- Some products generate high voltages, so never handle the cables/connectors when power is being supplied to the equipment.
- When powered up, all electrical equipment produces electromagnetic fields. These can cause adjacent pieces of electrical equipment to interact with one another, with a consequent adverse effect on operation.

To minimize these effects and enable you to get the best possible performance from your Raymarine equipment, guidelines are given in the installation instructions, to enable you to ensure minimum interaction between different items of equipment, i.e. ensure optimum Electromagnetic Compatibility (EMC).

- Always report any EMC-related problem to your nearest Raymarine dealer. We use such information to improve our quality standards.
- In some installations, it may not be possible to prevent the equipment from being affected by external influences. In general this will not damage the equipment but it can lead to spurious resetting action, or may result in momentary faulty operation.

7.2 Problem Solving

All Raymarine products are, prior to packing and shipping, subjected to comprehensive test and quality assurance programs. However, if this unit should develop a fault, please refer to the following table to identify the most likely cause and the corrective action required to restore normal operation.

If you still have a problem after referring to the table below, contact your local dealer, national distributor or Raymarine Technical Services Department for further advice. Always quote the product serial numbers. The serial number is printed on the back of the unit.

Common Problems and Their Solutions

Table 7-1: Common Problems

Problem	Correction
Unit does not function	<ol style="list-style-type: none"> 1. Make sure that the power supply cable is sound and that all connections are tight and free from corrosion. 2. Check the system fuse.
Display "freezes"	<ol style="list-style-type: none"> 1. Check the Scroll Speed is not set to PAUSE. 2. Check the transducer cable for damage. If damaged, the cable and transducer must be replaced as a unit.
Unit does not display fish	<ol style="list-style-type: none"> 1. Fish arches may not be displayed if the boat is stopped; fish may appear on the display as straight line. 2. Ensure the transducer is within 10° of vertical. 3. Check that the gain is not set too low.
Unit does not see bottom or fish	<ol style="list-style-type: none"> 1. Check that the transom-mount transducer hasn't kicked-up on hitting an object. 2. Check that the gain is not set too low. 3. Check that the transducer is within 10° of vertical. 4. Check that the transducer face is not covered or fouled. If necessary clean the transducer. 5. Check the voltage from the power source; if this is too low it can affect the transmitting power of the sounder.
Unit is unreliable at high boat speeds	Turbulence around the transducer may be confusing the unit.
Unit displays a lot of back-ground noise	<ol style="list-style-type: none"> 1. Check that the gain is not set too high. 2. Check that the transducer is mounted correctly and is clean.

Table 7-1: Common Problems

Problem	Correction
Sounder speed or log readings are wrong	1. Check that the transducer paddlewheel is clean. 2. If necessary, adjust the SPEED CALIBRATE parameter.
Temperature readings are wrong	If necessary, adjust the TEMP CALIBRATE parameter.

7.3 How to Contact Raymarine

On the Internet

Visit the Raymarine World Wide Web site for the latest information on Raymarine electronic equipment and systems at:

www.raymarine.com

Customer Support

Navigate to the **Customer Support** page for links for:

- Finding Factory Service locations and Authorized Dealers near you
- Registering your Raymarine products
- Accessing handbooks in Adobe Acrobat format
- Downloading RayTech software updates
- Accessing the Raymarine solution database

Clicking the **Find Answers** link routes you to our solution database. Search questions and answers by product, category, keywords, or phrases. If the answer you are seeking is not available, click the **Ask Raymarine** tab to submit your own question to our technical support staff, who will reply to you by e-mail.

In the US

Accessories and Parts

Many Raymarine accessory items and parts can be obtained directly from your authorized Raymarine dealer.

However, if you are in need of an item not available from the retailer, please contact Raymarine Technical Services at:

800-539-5539 ext. 2333, *or*
603-881-5200.

Technical Service is available Monday through Friday 4:00 AM to 6:00 PM Eastern Time.

Please have the Raymarine item or part number ready when calling if placing an order. If you are not sure which item is appropriate for your unit, you should first contact the Technical Support Department to verify your requirements:

800-539-5539 ext. 2444, *or*
603-881-5200.

Technical Support

For technical support, call:

800-539-5539 ext. 2444, *or*
603-881-5200.

Our Technical Support Specialists are available to answer questions about installing, operating and trouble-shooting all Raymarine products.

Questions can be sent directly to our Technical Support Department via the Internet. Point your browser to www.raymarine.com and click on the **Customer Support** link. From there, select **Find Answers** and click the **Ask Raymarine** tab.

Product Repair and Service

In the unlikely event your Raymarine unit should develop a problem, please contact your authorized Raymarine dealer for assistance. The dealer is best equipped to handle your service requirements and can offer timesaving help in getting the equipment back into normal operation.

In the event that repairs can not be obtained conveniently, product service may also be obtained by returning the unit to:

Raymarine, Inc.
Product Repair Center
22 Cotton Road, Unit D
Nashua, NH 03063-4219

The Product Repair Center is open Monday through Friday 8:15 a.m. to 5:00 p.m. Eastern Time. All products returned to the Repair Center are registered upon receipt. Should you wish to inquire about the repair status of your unit, contact the Product Repair Center at:

800-539-5539

Please have the product reference number, or unit serial number, ready when you call. We will do everything possible to make the repair and return your unit as quickly as possible.

In Europe

In Europe, Raymarine support, service and accessories may be obtained from your authorized dealer, or contact:

Raymarine Ltd
Anchorage Park
Portsmouth, Hampshire
England PO3 5TD
Tel: +44 (0) 23 9269 3611
Fax: +44 (0) 23 9269 4642

Technical Support

The Technical Services Department handles inquiries concerning installation, operation, fault diagnosis and repair. For technical helpdesk contact:

Tel: +44 (0) 23 9271 4713
Fax: +44 (0) 23 9266 1228

Accessories and Parts

Raymarine accessory items and parts are available through your authorized Raymarine dealer. Please refer to the lists of component part numbers and optional accessories in the Installation chapter of this manual and have the Raymarine part number ready when speaking with your dealer.

If you are uncertain about what item to choose for your unit, please contact our Customer Services Department prior to placing your order.

Worldwide Support

Please contact the authorized distributor in the country.

Appendix A: Specifications

General		
CE	Conforms to 89/336/EEC (EMC)	
Size	H x W x D, excluding mounting bracket 6.93 x 7.0 x 2.52 in (176 x 178 x 64 mm)	
Weight	1.87 lb (848 g)	
Environmental	Waterproofing:	Submersible to IPX7 standard; suitable for external mounting
	Temp Range - Operating:	+14°F to +122°F (-10°C to +50°C)
	Temp Range -Storage:	+4°F to +158°F (-20°C to +70°C)
	Humidity	up to 95% at 35°C, non-condensing
Power Input	10.0VDC to 18.0VDC, 13.8 VDC nominal	
	Consumption - Typical	<10W @ 12VDC
Mounting	Mounting Bracket or optional Flush Mount	
Controls	6 defined keys and trackpad	
Display	320 x 240 pixels (1/4 VGA) color portrait	
Display type	5.7" (145 mm) diagonal Transmissive TFT Color LCD	
Interface	7 pin Power/NMEA	NMEA 0183 receive and transmit
Connector	7 pin transducer	
Sounder		
Output Power:	Adjustable to 500 watts RMS	
Frequency	Dual 50 kHz and 200 kHz	
Pulse Length	100 µsec to 4 msec	
Max. Transmit Rate	1428 pulses / min. @ 50' range	
Depth	2 to 2000 ft (600 m), approx. (actual performance dependent upon transducer type and conditions in the water column)	

NMEA Data

Connector	Received	Transmitted
POWER/NMEA	BWC, BWR, GLL, ZDA, RMB, VTG, HDG, HDT	BWC, BWR, DBT, DPT, GLL, MTW, VHW, VLW, VTG, ZDA

Index

A

- Accessories 5
 - Obtaining 66
- Alarm Clock 49, 58
- Alarms 55
 - Alarm Clock 58
 - Deep Alarm 57
 - Deep Range 57
 - Fish Alarm 56
 - Shallow Alarm 56
 - Shallow Range 56
 - Target Depth ID 55
 - Temp Alarm 57
 - Temp Range 58
- Analog Gauges 47, 48
- A-Scope 33
- Auto Scroll 47

B

- Background Color 47
- Battery 47
- Bearing 49
- Bearing Mode 60
- Brightness 44

C

- Cables
 - Power 11
 - Running 7
 - Transducer 13
- Cleaning Instructions 63
- COG 49
- Color Gain 35
- Connections 11
 - Power 11
 - Transducer 11, 13
- Customer Support 66

D

- Data Items 47
 - Analog Gauges 47
 - Auto Scroll 47
 - Battery 47

- Log 47
- Speed 47
- Temperature 47
- Trip 47
- Date Format 49, 60
- Date Setting 49
- Deep Alarm 57
- Deep Range 57
- Depth Digit Size 45
- Depth Offset 62
- Depth Units 59
- Dimensions 8
- Display Setup 41
 - Brightness 44
- Data Items 47
 - Analog Gauges 47
 - Auto Scroll 47
 - Battery 47
 - Log 47
 - Speed 47
 - Temperature 47
 - Trip 47
- Depth Digit Size 45
- Menu List 43
- Nav Set Up
 - Alarm Clock 49
 - Bearing 49
 - COG 49
 - Date 49
 - Date Format 49
 - LAT/LONG 48
 - RNG/BRG 49
 - SOG 48
 - Time 49
 - Time Format 49
 - Time Offset 49
 - TTG 49
 - Waypoint 48
- Palette 46
 - Background Color 47
 - Target Depth ID 44
 - Transparent Menu 45
- Distance
 - Determining Using VRM 20
- Distance Units 59

E

- Echoes 16
 - Strength 17
- ENTER key 19

F

- Features 2
- Fish Alarm 56
- Fishfinder
 - Basic System 2
 - Typical Display Screen 17
- Fishfinder Page 16, 19, 21
- Frequency 32
- Fuse 12

G

- Gain 35
 - Color Gain 35
- Gain Mode 34
 - Int Rej 36
 - Max Ping Rate 37
 - Power 37
 - Second Echo Rejection 37
 - TVG 36

H

- Help from Raymarine 66

I

- Installation 5
 - Cables 7
 - EMC Guidelines 5
 - Location 6
 - Mounting 9

- Int Rej 36

K

- Key Beep 61
- Key Help 61
- Keypad 19

L

- Language 61
- LAT/LONG 48
- List
 - Display Set Up Menu items 43
 - Main Menu items 29

- Sounder Set Up Menu items 53

Location

- Mounting 6

- Log 47

M

- Main Menu 25
 - List 29
- Maintenance 63
- Max Ping Rate 37
- Menu 30
 - A-Scope 33
 - Frequency 32
 - Gain
 - Color Gain 35
 - Gain Mode 34, 36
 - Gain Settings 35
 - Int Rej 36
 - Max Ping Rate 37
 - Power 37
 - Second Echo Rejection 37
- Main 25
- Operation 23
- Range 30
- Scroll Speed 30
- Selecting 25
- Structure 23
- Trip Reset 39
- Zoom 37
 - Magnification 39
 - Mode 39
 - View 38

- Menu Items 29

- MENU key 19

- Menu List 29

- Display Set Up 43

- Main Menu 29

- Sounder Set Up 53

- Mounting 9

N

- Nav Data Page 19, 21

- Nav Set Up 48

- Alarm Clock 49

- Bearing 49

- COG 49

- Date 49
- Date Format 49
- LAT/LONG 48
- RNG/BRG 49
- SOG 48
- Time 49
- Time Format 49
- Time Offset 49
- TTG 49
- Waypoint 48
- Navigation Data 48
- NMEA-out Set Up 60

P

- Page 19, 21
 - Fishfinder 16
- Palette 46
 - Background Color 47
- Parts 5
- Power 37
 - Cable 11
 - Connection 11
- POWER key 20
- Power on 15

Q

- QUIT key 19

R

- Range 30
- Range and Bearing 49
- RANGE key 20
- Raymarine
 - Addresses 67
 - Phone numbers 67
 - Website 66
- Repair 67
- RNG/BRG 49
- Routine Checks 63

S

- Safety
 - EMC Guidelines 5
- Scroll 47
- Scroll Speed 30
- Scrolling Bottom Graph 16
- Second Echo Rejection 37

- Selecting Menu Items 25
- Serial Number 62
- Service 67
- Shallow Alarm 56
- Shallow Range 56
- Simulator 15, 62
- Software Version 62
- SOG 48
- Sonar
 - Basic System 2
 - Echoes 16
 - Image 17
 - Signal Strength 17
 - Target Indications 18
- Sounder Setup 51
 - Alarms 55
 - Alarm Clock 58
 - Deep Alarm 57
 - Deep Range 57
 - Fish Alarm 56
 - Shallow Alarm 56
 - Shallow Range 56
 - Target Depth ID 55
 - Temp Alarm 57
 - Temp Range 58
 - Depth Offset 62
 - Key Beep 61
 - Key Help 61
 - Language 61
 - Menu List 53
 - NMEA-out Set Up 60
 - Serial Number 62
 - Sounder Simulator 62
 - Speed Calibrate 62
 - SW Version 62
 - Temp Calibrate 62
 - Units 59
 - Bearing Mode 60
 - Date Format 60
 - Depth Units 59
 - Distance Units 59
 - Speed Units 59
 - Temp Units 59
 - Time Format 60
- Sounder Simulator 62

- Specifications 69
- Speed 47
- Speed Calibrate 62
- Speed Units 59
- Supplied Parts 5
- System
 - Connections 11

T

- Target Depth ID 44, 55
- Target Indications 18
- Technical Support 67
- Temp Alarm 57
- Temp Calibrate 62
- Temp Graph Page 19, 21
- Temp Range 58
- Temp Units 59
- Temperature 47
- Time Format 49, 60
- Time Offset 49
- Time Setting 49
- Trackpad 20
- Transducer 3
 - Cable 13
 - Cleaning 63
 - Connections 11, 13
- Transparent Menu 45
- Trip 47
- Trip Reset 39
- TTG 49
- TVG 36

U

- Units 59
 - Bearing Mode 60
 - Date Format 60
 - Depth Units 59
 - Distance Units 59
 - Speed Units 59
 - Temp Units 59
 - Time Format 60

V

- VRM 19, 20

W

- Warranty iii

- Waypoint 48
- Website 66

Z

- Zoom 20, 37
 - Magnification 39
 - Mode 39
 - View 38