



HX270S

VHF/FM Marine
Handheld Transceiver

Owner's Manual

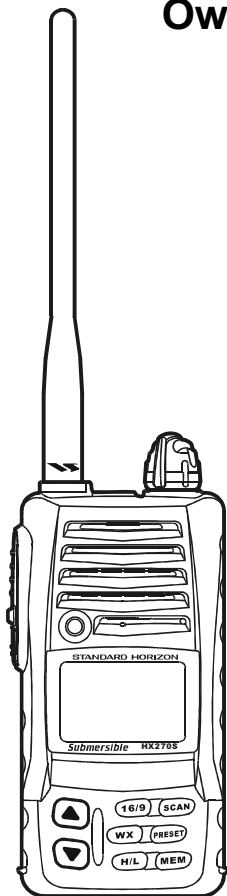

TABLE OF CONTENTS

FCC LICENSE INFORMATION	3
FCC NOTICE	4
1. GENERAL INFORMATION	5
2. ACCESSORIES	6
2.1 PACKING LIST	6
2.2 OPTIONS	6
3. BATTERY	7
3.1 BATTERY CHARGING	7
3.2 BATTERY REMOVAL/INSTALLATION	7
3.3 USING THE NC-88 BATTERY CHARGER	8
3.4 FBA-25A ALKALINE BATTERY CASE	8
3.5 BATTERY SAFETY	9
4. CONTROLS AND INDICATORS	10
4.1 CONTROLS and CONNECTIONS	11
4.2 INDICATORS	13
5. OPERATION	15
5.1 INITIAL SETUP	15
5.2 RECEPTION	16
5.3 TRANSMISSION	17
5.4 TRANSMIT TIME-OUT TIMER (TOT)	17
5.5 USA, CANADIAN, AND INTERNATIONAL BANDS	18
5.6 NOAA WEATHER CHANNELS	18
5.7 SCAN	19
5.8 PROGRAMMABLE PRIORITY SCAN	20
5.9 DUAL WATCH	20
5.10 EMERGENCY (CHANNEL 16 USE)	21
5.11 CALLING ANOTHER VESSEL (CHANNEL 16 OR 9)	21
5.12 OPERATING ON CHANNEL 13	22
5.13 OPERATING ON CHANNEL 67	22
5.14 PRESET CHANNELS (1 ~ 8): INSTANT ACCESS	23
5.15 SIMPLEX/DUPLEX CHANNEL USE	23
5.16 SETUP MODE	24
6. MAINTENANCE	26
7. PRODUCT SUPPORT INQUIRIES	27
8. CHANNEL ASSIGNMENTS	27
9. WARRANTY	34
10. SPECIFICATIONS	37

RF Exposure Safety Statement

This Radio has been tested and complies with the Federal Communications Commission (FCC) RF exposure limits for Occupational Use/Controlled exposure environment. In addition, it complies with the following Standards and Guidelines:

- FCC@96-326, Guidelines for Evaluating the Environmental Effects of Radio-Frequency Radiation.
- FCC OET Bulletin 65 Edition 97-01 (1997) Supplement C, Evaluating Compliance with FCC Guidelines for Human Exposure to Radio Frequency Electromagnetic Fields.
- ANSI/IEEE C95.1-1992, IEEE Standard for Safety Levels with Respect to Human Exposure to Radio Frequency Electromagnetic Fields, 3kHz to 300 GHz.
- ANSI/IEEE C95.3-1992, IEEE Recommended Practice for the Measurement of Potentially Hazardous Electromagnetic Fields-RF and Microwave.

WARNING

This radio generates RF electromagnetic energy during transmit mode. This radio is designed for and classified as Occupational Use Only, meaning it must be used only during the course of employment by individuals aware of the hazards, and the ways to minimize such hazards. This radio is not intended for use by the General Population in an uncontrolled environment.

CAUTION

To ensure that your exposure to RF electromagnetic energy is within the FCC allowable limits for occupational use, always adhere to the following guidelines:

SAFETY INFORMATION

This radio is NOT approved for use by the general population in an uncontrolled environment. This radio is restricted to occupational use, work related operations only where the radio operator must have the knowledge to control its RF exposure conditions.

- When transmitting, hold the radio in a vertical position with its microphone 1 to 2 inches (2.5 to 5 cm) away from your mouth and keep the antenna at least 1 inch (2.5cm) away from your head and body.
- The radio must be used with a maximum operating duty cycle not exceeding 50 %, in typical Push-to-Talk (Manual PTT) configurations.
DO NOT transmit for more than 50 % of total radio use time (50 % duty cycle). Transmitting more than 50 % of the time can cause FCC RF exposure compliance requirements to be exceeded.
The radio is transmitting when the red LED on the front panel of the radio is illuminated. You can cause the radio to transmit by pressing the PTT button.
- Only use the Standard Horizon accessories designed for this product detailed on Page 6.

Congratulations on your purchase of the **HX270S**! Whether this is your first portable marine VHF transceiver, or if you have other STANDARD HORIZON equipment, the STANDARD HORIZON organization is committed to ensuring your enjoyment of this high-performance transceiver, which should provide you with many years of satisfying communications even in the harshest of environments. STANDARD HORIZON technical support personnel stand behind every product we sell, and we invite you to contact us, should you require technical advice or assistance, at (800)767-2450.

We appreciate your purchase of the **HX270S**, and encourage you to read this manual thoroughly, so as to learn and understand the capabilities of the **HX270S** fully.

ABOUT VHF MARINE RADIO

The radio frequencies used in the VHF marine band lie between 156 and 158 MHz with some shore stations available between 161 and 163 MHz. The marine VHF band provides communications over distances that are essentially "line of sight" (VHF signals do not travel well through objects such as buildings, hills or trees). Actual transmission range depends much more on antenna type, gain and height than on the power output of the transmitter. The approximate distance a portable 5W radio may communicate is about 5 miles in if there are no obstructions (buildings, hills etc.) restricting line of sight transmission.

FCC RADIO LICENSE INFORMATION

Standard Horizon radios comply with the Federal Communication Commission (FCC) requirements that regulate the Maritime Radio Service.

PROHIBITED COMMUNICATIONS

The FCC prohibits the following communications:

- False distress or emergency messages;
- Messages to "any boat" except in emergencies and radio tests;
- Messages to or from a vessel on land;
- Transmission while on land;
- Obscene, indecent, or profane language (potential fine of \$10,000).

STATION LICENSE

An FCC ship station license is no longer required for any vessel traveling in U.S. waters which uses a VHF marine radio, RADAR or EPIRB, and which is not required to carry radio equipment. FCC license forms, including applications for ship (506) and land station licenses can be downloaded via the Internet at www.fcc.gov/formpage.html. To obtain a form from the FCC, call (888) 225-5322.

RADIO CALL SIGN

Currently the FCC does not require recreational boaters to have a Ship Radio Station License. The USCG recommends the boat's registration number and the state to be used.

CANADIAN SHIP STATION LICENSING

You may need a license when traveling in Canada. If you do need a license contact their nearest field office or regional office or write:

**Industry Canada
Radio Regulatory Branch
Attn: DOSP
300 Slater Street
Ottawa, Ontario
Canada, KIA 0C8**

FCC/INDUSTRY CANADA INFORMATON

The following data pertaining to the transceiver is necessary to fill out the license application.

FCC Type Accepted Part 80
Output Power with FNB-83 1 W (Low), 2.5 W (Mid), and 5 W (High)
Emission 16K0G3E
Frequency Range 156.025 to 157.425 MHz
FCC Type Number K6630073X20
Industry Canada Type Approval 511B-30073X20

FCC NOTICE

Unauthorized changes or modifications to this equipment may void compliance with FCC Rules. Any change or modification must be approved in writing by STANDARD HORIZON, the Marine Division of VERTEX STANDARD.

NOTICE

This equipment has been tested and found to comply with the limits for a Class B digital device, pursuant to Part 15 of the FCC Rules. These limits are designed to provide reasonable protection against harmful interference in a residential installation. This equipment generates, uses and can radiate radio frequency energy and, if not installed and used in accordance with the instructions, may cause harmful interference to radio communications. However, there is no guarantee that interference will not occur in a particular installation. If this equipment does cause harmful interference to radio or television reception, which can be determined by turning the equipment off and on, the user is encouraged to try to correct the interference by one or more of the following measures:

- Increase the separation between the equipment and receiver.
- Connect the equipment into an outlet on a circuit different from that to which the receiver is connected.
- Consult the dealer or an experienced marine electronics technician for help.

1. GENERAL INFORMATION

1.1 INTRODUCTION

The **HX270S** is a submersible, miniature 5-Watt portable two-way VHF marine transceiver. The transceiver has all allocated USA, international, or Canadian channels. It has an emergency channel 16 which can be immediately selected from any channel by pressing the **16/9** key. NOAA weather channels can also be accessed immediately by pressing the **WX** key.

The transceiver includes the following features: Memory Scanning, Programmable Priority Scanning, NOAA Weather Alert, Battery Saver, easy-to-read large LCD display, EEPROM memory back-up, Battery Life displayed on LCD, and a transmit Time-Out Timer (TOT).

The transmitter provides a maximum of 5 Watts output, and has the selection of 2.5 Watts and 1 Watt to assist the user in ensuring maximum battery life.

2. ACCESSORIES

2.1 PACKING LIST

When the package containing the transceiver is first opened, please check it for the following contents:

- **HX270S** Transceiver
- **FNB-83** 7.2 V, 1400 mAh Ni-MH Battery Pack
- **NC-88B** 120 VAC Overnight Charger
- **CD-26** Charger Cradle
- **FBA-25A** Alkaline Battery Case
- **CAT460** Antenna
- **E-DC-19A** DC Cable with 12 V Cigarette Lighter Plug
- **CLIP-14** Belt Clip with screw
- **Owner's Manual**

2.2 OPTIONS

- ① **CD-26** Charger Cradle
- ② **FBA-25A** Alkaline Battery Case
- ③ **FNB-83** 7.2 V, 1400 mAh Ni-MH Battery Pack
- ④ **E-DC-19A** DC Cable with 12 V Cigarette Lighter Plug
- ⑤ **NC-88B** 120 VAC Overnight Charger
- ⑥ **E-DC-6** DC Cable; plug and wire only
- VAC370** Rapid Charger
- CE68** PPS Software
- CT-111** Cable SET for CE68
- CAW230** Radio-to-Ship's-Antenna Adapter

Note: Before operating the **HX270S** for the first time, it is recommended that the battery be charged.

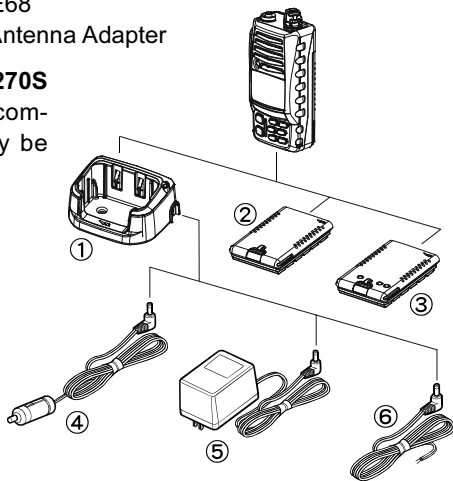

3. BATTERY

The **FNB-83** is a high performance rechargeable battery providing high capacity in a compact package.

3.1 BATTERY CHARGING

If the radio has never been used, or its charge is depleted, it may be charged by connecting the **NC-88** battery charger (see figure 2 on page 8). If 12V DC power is available, the optional **E-DC-6** or the **E-DC-19A** DC adapter with cigarette plug may be used for charging the battery. The **NC-88**, **E-DC-6** and **E-DC-19A** will charge a completely discharged **FNB-83** battery pack in about 10 hours.

3.2 BATTERY REMOVAL/INSTALLATION

1. Turn the transceiver off.
2. To remove, open the Battery Pack Latch on the bottom of the transceiver, then slide the battery downward and out from the transceiver.
3. To install, insert the battery pack into the battery compartment on the back of the transceiver, then close the Battery Pack Latch until it locks in place with a “click.”

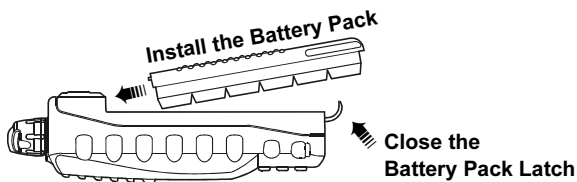

Figure 1

Important Notice

To avoid the ingress of water between the transceiver body and battery pack/case, close the Battery Pack Latch until it locks in place with a “click” while pressing and holding the battery pack/case in to ward the top panel (secure the upper edge of the battery pack/case snugly against the upper edge of the battery nest).

3.3 USING THE NC-88 BATTERY CHARGER

1. Install the supplied **FNB-83** battery pack on the rear of the **HX270S**. Ensure that the transceiver is switched off.
2. Plug the **NC-88** Overnight Charger into the AC line outlet, then insert the cable plug into the jack located on the side panel of the **CD-26** Charger Cradle.
3. Insert the transceiver and battery pack into the **CD-26**; the antenna jack should be at the left side when viewing the charger from the front.
4. If the transceiver and battery pack are inserted correctly, the Red indicator on the **CD-26** will glow. A fully-discharged pack will be charged completely in 10 hours.

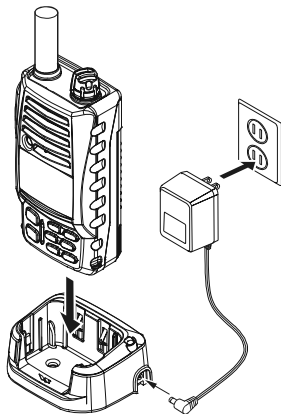

Figure 2

Important Notes:

- The **NC-88** is not designed to power the transceiver for operation (reception or transmission).
- Do not leave the charger connected to the transceiver for continuous periods in excess of 24 hours. Long term overcharging can degrade the Ni-MH battery pack and significantly shorten its useful life.
- If using a charger other than the **NC-88/CD-26**, or if using a battery pack other than the **FNB-83**, follow the appropriate instructions provided with the charger/battery. Contact your Dealer if you have any doubts about the appropriateness of the particular charger or battery pack you intend to use.

3.4 FBA-25A Waterproof Alakline Battery Tray

FBA-25A is a battery case that holds six alkaline batteries and is used with the **HX270S** transceiver.

When installing batteries, insert the (-) end first, then press in the (+) end so the battery snaps into place. Always replace all six batteries at the same time, paying attention to the polarity indicated inside the case.



The FBA-25A must not be used with rechargeable cells. The FBA-25A does not contain the thermal and over-current protection circuits (provided in the "FNB" series of Ni-MH Battery Packs) required when utilizing Ni-Cd and Ni-MH cells.

3.5 BATTERY SAFETY

Battery packs for your transceiver contain Ni-MH batteries. This type of battery stores a charge powerful enough to be dangerous if misused or abused, especially when removed from the transceiver. Please observe the following precautions:

DO NOT SHORT BATTERY PACK TERMINALS

Shorting the terminals that power to the transceiver can cause sparks, severe overheating, burns, and battery cell damage. If the short is of sufficient duration, it is possible to melt battery components. Do not place a loose battery pack on or near metal surfaces or objects such as paper clips, keys, tools, etc. When the battery pack is installed on the transceiver, the terminals that transfer current to the transceiver are not exposed.

DO NOT INCINERATE

Do not dispose of any battery in a fire or incinerator. The heat of fire may cause battery cells to explode and/or release dangerous gases.



Never short-circuit the connection terminals on the battery or charger !



CONTAINS NICKEL-METAL-HYDRIDE BATTERY.
MUST BE RECYCLED OR DISPOSED OF PROPERLY.

4. CONTROLS AND INDICATORS

NOTE

This section defines each control of the transceiver. For detailed operating instructions, refer to section 5 of this manual. Refer to Figure 3 for the location of the following controls, indicators, and connections.

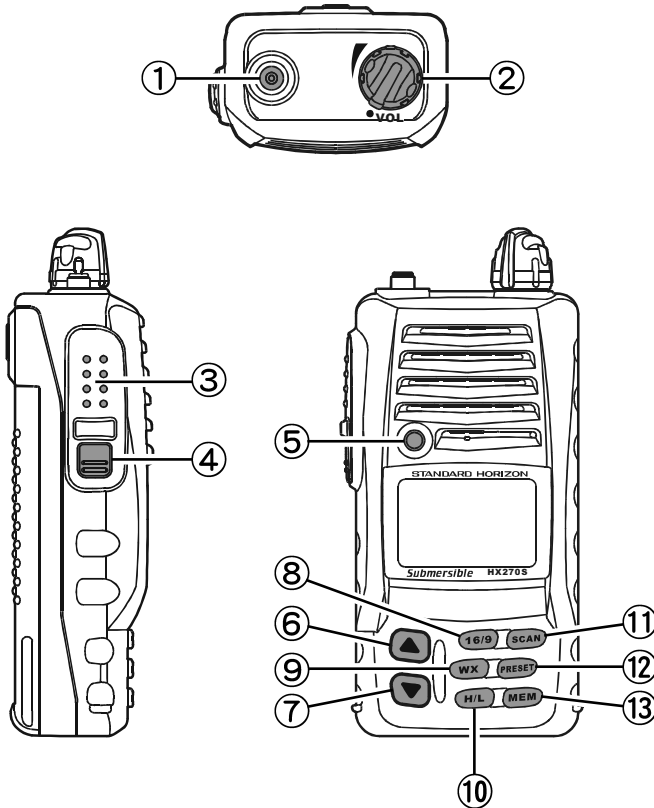

Figure 3
Controls and Connectors

4.1 CONTROLS AND CONNECTIONS

① Antenna Connector

The supplied **CAT460** flexible antenna is attached here.

② POWER SWITCH/VOLUME CONTROL

Turns the transceiver on and off, and adjusts the volume.

③ PUSH-TO-TALK (PTT) SWITCH

Activates transmission.

④ SQUELCH (SQL) SWITCH

Sets the point at which random noise on the channel does not activate the audio circuits but a received signal does. This point is called the Squelch threshold. Further adjustment of the squelch control will degrade the reception of wanted transmissions.

⑤ BUSY/TX INDICATOR

This indicator glows **green** when a signal is being received and **red** when transmitting.

⑥ UP (▲) KEY

Used to select a desired channel. Each press increases the channel number. When held down, the channels increase continuously.

⑦ DOWN (▼) KEY

Used to select a desired channel. Each press decreases the channel number. When held down, the channels decrease continuously.

⑧ 16/9 KEY

Immediately recalls channel 16 from any channel location. Holding down this key recalls channel 9. The 16/9 key is also used to revert to the channel selected before pressing the 16/9 key.

Example: select Ch68, press 16/9 key (Ch16 appears), press the 16/9 key again and Ch68 is shown.

⑨ **WX KEY**

Immediately recalls the last-used NOAA Weather Channel from any channel location. Recalls the previously- selected working channel when the **WX** key is pressed again.

Secondary use: When the **16/9** key is held *and* the **WX** key is pressed, the radio will change modes between the USA, International, and Canadian channel bands.

⑩ **H/L KEY**

Toggles the transmitter power level between High (5 Watts), Medium (2.5 Watts), and Low (1 Watt) of output. Does not operate on “low power only” and transmission-inhibit channels.

When operating on Canadian channel 13, or USA channels 13 or 67, pressing this key momentarily toggles the power level from Low power to Medium or High power.

Hold down this key to lock the displayed channel functions (except the **H/L**, **PTT**, and **SQL** keys) so that they are not accidentally changed. The key lock symbol “**On**” will appear, to indicate that the functions are locked. Hold down until the key lock symbol “**On**” disappears to unlock the radio.

⑪ **SCAN KEY**

Starts scanning and Priority scanning of programmed channels. When scanning, press and hold this key to turn on and off Priority scan (**P** is shown on the left side of the display during Priority scanning).

⑫ **PRESET KEY**

Immediately recalls one of up to eight user preset memories for operation (shown as 1-8 on the LCD). Pressing this key repeatedly scrolls through the preset memory channels.

⑬ **MEM KEY**

Press to select a channel for scanning. Press this key again to delete a memorized channel. (“**MEM**” appears on the LCD display during memory operation).

4.2 INDICATORS

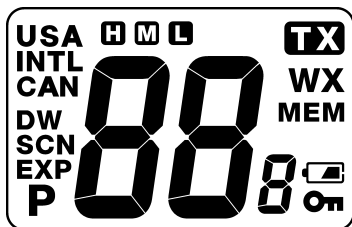

Figure 4
Indicators

Channel Display

The operating channel is shown on the LCD in both the transmission and reception modes.

A Indicator

Signifies ship-to-ship channels in USA or Canadian mode (whose counterpart in the International mode is a public correspondence (marine operator) channel).

USA/INTL/CAN Indicator

Denotes the “band” of operation for the particular channel. “USA” indicates the USA band; “CAN” indicates the Canadian band; and “INTL” indicates the International band.

H/M/L Indicators

“H” indicates High power (5 Watts); “M” indicates Medium power (2.5 Watts); and “L” is for Low power (1 Watt). “Blank” in this location indicates a receive-only channel.

P Indicator

Ch16 Priority Scan is activated.

DW Indicator

Dual watch is activated.

SCN Indicator

Scan is activated.

TX Indicator

Appears during transmission.

WX Indicator



A NOAA weather channel is selected.

MEM Indicator

The channel is in the transceiver's "Scan Memory."

Battery Indicator

When the battery charge is almost depleted, a " icon will appear on the display. When this icon appears, it is recommended that you charge the battery soon.

No Icon	Enough battery power
	Lower battery power
	Nearing depletion
 (Blinking)	Prepare to charge the battery

NOTE: The battery indicator should be used only as a guide in charging the **FNB-83** battery.

KEY Lock Indicator

When the " symbol is shown on the LCD, all keys are disabled except for the **H/L**, **PTT** and **SQL** keys.

5. OPERATION

5.1 INITIAL SETUP

1. Install the belt clip on the transceiver, if desired.
2. Install the battery pack on the transceiver (see figure 1 and section 3.2).
3. Install the antenna onto the transceiver.

NOTE

Water resistance of the transceiver is assured only when the battery pack and antenna are attached to the transceiver.

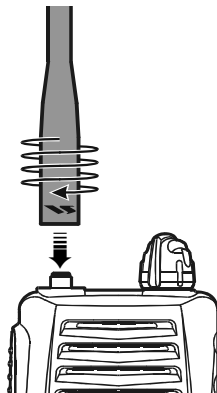

Figure 5
Antenna Installation

Installing the Quick Draw Belt Clip

1. Connect the hanger to the rear of the **HX270S**, with the notch pointing directly up, using the supplied screw (Figure 6-a).

Use only the screw included with the clip to mount the clip to the back of the transceiver!

2. Clip the Quick Draw Belt Clip to your belt (Figure 6-b).
3. To install the **HX270S** into the Quick Draw Belt Clip, align the hanger with the Quick Draw Belt Clip and slide the **HX270S** into its slot until a click is heard.
4. To remove the **HX270S** from the Quick Draw Belt Clip, Rotate the **HX270S** 180 degrees, then slide the transceiver out from the Quick Draw Belt Clip (Figure 6-c).

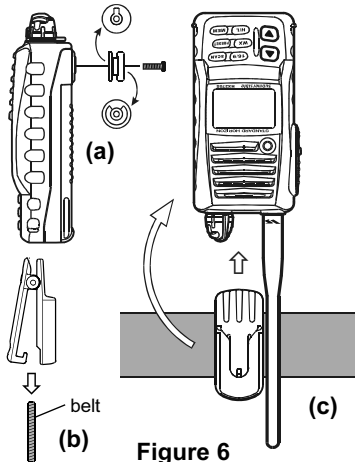

Figure 6

5.2 RECEPTION

1. Turn the **POWER/VOLUME CONTROL** knob clockwise to turn the transceiver on.
2. Press the **SQL** key, then press the [▼] key until the SQL level is **00**.
3. Turn up the **POWER/VOLUME CONTROL** knob until the noise or audio from the speaker is at a comfortable level.
4. Select a channel that has no signal being received (no one is transmitting on the channel) and where only noise is heard.
5. Press the **SQL** key, then press the [▲] key and stop immediately after the noise disappears. This condition is known as the “Squelch Threshold.” If the squelch is set to a higher level, weak signals may not be received.
6. To change channels, press the [▲] or [▼] key.
7. The LCD and keypad are illuminated for 5 seconds when any key is pressed. The lamp automatically turns off in 5 seconds.
8. To “lock” the channel so that it is not accidentally changed, hold down the **H/L** key for about one second. This locks the [▲] and [▼] buttons and all the front panel controls except the **H/L**, **PTT** and **SQL** keys. The “**Om**” symbol will appear on the display to indicate that the keypad is locked. Hold down the **H/L** key for about one second to unlock the keys. The “**Om**” symbol will disappear from the display.



5.3 TRANSMISSION

NOTE

Never key the transceiver without an antenna connected, as this may cause damage to the transceiver.

1. Perform steps 1 through 7 of the RECEPTION discussion above.
2. Before transmitting, monitor the channel and make sure it is clear.

THIS IS AN FCC REQUIREMENT!

3. For communications over short distances, press the **H/L** key until “**L**” is displayed on the LCD. This indicates Low power (approximately 1 Watt).

NOTE

Transmitting on 1 Watt prolongs battery life. Low power (1 Watt) should be selected whenever possible.

4. If using Low power is not effective, select Medium power (2.5 Watts) or High power (5 Watts) by pressing the **H/L** key until “**M**” (Medium power) or “**H**” (High power) is displayed.



5. When receiving a signal, wait until the incoming signal stops before transmitting. The transceiver cannot transmit and receive simultaneously.
6. Press the **PTT** (Push-To-Talk) switch to transmit. The “**TX**” indicator is displayed during transmission.
7. Speak slowly and clearly into the microphone. Hold the microphone about ½ to 1 inch away from your mouth.
8. When the transmission is finished, release the **PTT** switch.

5.4 TRANSMIT TIME - OUT TIMER (TOT)

While the **PTT** switch is held down, transmission time is limited to 5 minutes. This prevents prolonged (unintentional) transmissions. About 10 seconds before automatic transmitter shutdown, a warning beep sounds from the speaker. The transceiver automatically switches to the receiving mode, even if the **PTT** switch is held down. Before transmitting again, the **PTT** switch must first be released, then pressed again. This **Time-Out Timer (TOT)** prevents a continuous transmission that would result from an accidentally stuck **PTT** switch.

5.5 USA, CANADIAN, AND INTERNATIONAL BANDS

1. To change the operating band (channel set) of the transceiver, hold down the **16/9** key and press the **WX** key. The band will change from USA, to International, and to Canadian with each press.
2. “**USA**” appears on the LCD for the USA band, “**INTL**” appears for the International band, and “**CAN**” appears for the Canadian band.



5.6 NOAA WEATHER CHANNELS

1. To receive a NOAA weather channel, press the **WX** key. The transceiver changes to the weather channel mode. This mode consists of a special pre-set memory bank containing the standard NOAA weather channels.
2. The transceiver will be set to the last-used NOAA weather channel. Press the [**▲**] or [**▼**] key to change to other weather channels.
3. To exit from the weather channel mode, press the **WX** key. The transceiver will revert to the channel you were using prior to switching to the weather channel mode.



5.6.1 NOAA WEATHER ALERT

In the event of extreme weather disturbances such as storms and hurricanes, NOAA (National Oceanic and Atmospheric Administration) sends a “weather alert” consisting of a 1050 Hz tone, followed by weather reports on the weather channels. The transceiver is capable of receiving this alert if the following is performed:

1. Program your area’s weather channels into the transceiver’s scan memory. Follow the same procedure as for regular channels under Section 5.7.
2. Press the **SCAN** key to start the scan.
3. The memorized weather channels are scanned along with the regular memorized channels. Scanning will not stop, however, on the (continuous) weather broadcast channels unless the weather alert tone is received.
4. When an alert is received on a weather channel, scanning stops and the transceiver emits a beeping tone that will stay on for 5 minutes or until the user presses the **WX** key to listen to the Weather Alert.

5.6.2 NOAA WEATHER ALERT TESTING

In the event of a major storm or other appreciable weather condition requiring vessels at sea or other bodies of water to be notified, the NOAA (National Oceanographic and Atmospheric Administration) broadcasts a 1050 Hz tone that the **HX270S** can detect. (Refer to section 5.6.1 “NOAA WEATHER ALERT” on how to use this feature.) This tone, when detected, will produce a loud beep from the radio speaker to signal that a weather alert is being broadcast.

In order to test this system, the NOAA broadcasts the 1050 Hz tone every Wednesday, sometime between 11 AM and 1 PM. Any marine VHF radio that can detect the weather alert tone, may use this test to verify that this feature is functioning properly.

5.7 SCAN

This transceiver provides a special “Scanning Memory Bank” which allows you to designate certain channels for inclusion in a “loop” which will be scanned at high speed. If an incoming signal is detected on one of the channels in the scanning loop, the radio will pause on that channel, allowing you to listen to the incoming transmission.

1. Select the desired channel to be included in the scanning loop using the [▲] or [▼] key.
2. Press the **MEM** key to store the channel into the transceiver’s scanning memory. “**MEM**” will be displayed on the LCD.
3. Repeat steps 1 and 2 for all the channels to be scanned.
4. To delete a channel from the transceiver’s scan memory, press the **MEM** key again while the memorized channel is displayed. “**MEM**” will disappear from the display.
5. All channels programmed remain in the transceiver’s scan memory even if the power is turned off.
6. Press the **SQL** key, then press the [▲] or [▼] key until background noise is eliminated.
7. To start scanning, press the **SCAN** key. The scan proceeds from the lowest to the highest programmed channel number and stops on channels when a transmission is received. Scanning will resume when the squelch closes after the incoming signal disappears at the end of the transmission.
8. To stop the scan, press the **SCAN**, **16/9**, or **WX** key.



5.8 PROGRAMMABLE PRIORITY SCAN

The priority scanning feature allows the radio to scan while also keeping watch on a particularly important “priority channel.” The following channels can be set as the priority channel: 16, 09, and Preset Channels 1 through 8 (Preset Channels are described in section 5.14).

1. To set the priority channel, hold down the **16/9** key and press the **MEM** key. The channel will change from 16 to 09 to Preset 1 to Preset 2 to Preset 3 to Preset 4 to Preset 5 to Preset 6 to Preset 7 to Preset 8 with each press of the **MEM** key. The displayed channel will be set as the priority channel when the **16/9** key is released.
2. For priority scanning, hold down the **SCAN** key during normal scanning. Scanning will proceed between the memorized channels and the priority channel. The priority channel will be scanned after each programmed channel. “**P**” is shown on the left side of the channel number during priority scanning.
3. As an example of priority scanning, let us say that channels 06, 07, and 08 are memorized in the transceiver’s scan memory. Priority scanning will proceed in the following sequence:

[CH06] ➡ [Priority Channel] ➡ [CH07] ➡ [Priority Channel] ➡
➡ [CH08] ➡ [Priority Channel] ➡ [CH06] ➡ [Priority Channel]

4. Even when the transceiver stops and listens to the signal of a programmed channel, the transceiver will “dual watch” between this channel and the priority channel. Therefore, your priority watching of the designated channel is not compromised when the scanner has paused on an active channel.

5.9 DUAL WATCH

The Dual Watch feature allows the radio to watch for a transmission on the priority channel and another selected Marine channel until a signal is received. The priority channel is determined per the discussion in section 5.8 “PROGRAMMABLE PRIORITY SCAN” as described previously.

1. To start the Dual Watch feature, select a channel to be dual watched with the priority channel and press and hold in the **SCAN** key. The radio checks the priority channel for voice traffic every one second. A small “**DW**” icon will be shown blinking on the left of the display during scanning.
2. To cancel the Dual Watch feature, press the **SCAN** key.



5.10 EMERGENCY (CHANNEL 16 USE)

Channel 16 is known as the Hail and Distress Channel. An emergency may be defined as a threat to life or property. In such instances, be sure the transceiver is on and set to CHANNEL 16. Then use the following procedure:

1. Press the PTT (push-to-talk) switch and say “**Mayday, Mayday, Mayday**”. This is _____, _____ ” (your vessel’s name).
2. Then repeat once: “**Mayday**, _____ ” (your vessel’s name).
3. Now report your position in latitude/longitude, or by giving a true or magnetic bearing (state which) to a well-known landmark such as a navigation aid or geographic feature such as an island or harbor entry.
4. Explain the nature of your distress (sinking, collision, aground, fire, heart attack, life-threatening injury, etc.).
5. State the kind of assistance you desire (pumps, medical aid, etc.).
6. Report the number of persons aboard and condition of any injured.
7. Estimate the present seaworthiness and condition of your vessel.
8. Give your vessel’s description: length, design (power or sail), color and other distinguishing marks. The total transmission should not exceed 1 minute.
9. End the message by saying “**OVER**”. Release the PTT (push-to-talk) switch and listen.
10. If there is no answer, repeat the above procedure. If there is still no response, try another channel.
11. To recall the previously-selected channel, press the **16/9** key again.

5.11 CALLING ANOTHER VESSEL (CHANNEL 16 OR 9)

Channel 16 may be used for initial contact (hailing) with another vessel.

However, its most important use is for emergency messages. This channel must be monitored at all times except when actually using another channel.

It is monitored by the U.S. and Canadian Coast Guards and by other vessels. Use of channel 16 for hailing must be limited to initial contact only. Calling should not exceed 30 seconds, but may be repeated 3 times at 2-minute intervals. In areas of heavy radio traffic, congestion on channel 16 resulting from its use as a hailing channel can be reduced significantly in U.S. waters by using **Channel 9** as the initial contact (hailing) channel for non-emergency communications. Here, also, calling time should not exceed 30 seconds but may be repeated 3 times at 2-minute intervals.

Prior to making contact with another vessel, refer to the channel charts in this manual, and select an appropriate channel for communications after initial contact. For example, Channels 68 and 69 of the U.S. VHF Charts are some of the channels available to non-commercial (recreational) boaters. Monitor your desired channel in advance to make sure you will not be interrupting other traffic, and then go back to either channel 16 or 9 for your initial contact.

When the hailing channel (16 or 9) is clear, state the name of the other vessel you wish to call and then **“this is”** followed by the name of your vessel and your Station License (Call Sign). When the other vessel returns your call, immediately request another channel by saying **“go to,”** the number of the other channel, and **“over.”** Then switch to the new channel. When the new channel is not busy, call the other vessel.

After a transmission, say **“over,”** and release the microphone’s push-to-talk (PTT) switch. When all communication with the other vessel is completed, end the last transmission by stating your Call Sign and the word **“out.”** Note that it is not necessary to state your Call Sign with each transmission, only at the beginning and end of the contact.

Remember to return to Channel 16 when not using another channel. Some radios automatically monitor Channel 16 even when set to other channels or when scanning; see your Owner’s Manual.

5.12 OPERATING ON CHANNEL 13

Channel 13 is used at docks, bridges and for maneuvering in port. Messages on this channel must concern navigation only, such as meeting and passing in restricted waters. In emergencies and when approaching blind river bends, High power is allowed. Pressing the **H/L** key will change the power output from 1 Watt (**L**) to 5 Watts (**H**); if pressed again, 2.5 Watts (**M**) will be selected. When the **PTT** switch is released, the transceiver will revert to Low power. Press the **H/L** key again if you need High power on a subsequent transmission.

5.13 OPERATING ON CHANNEL 67

When channel 67 is used for navigational bridge-to-bridge traffic between ships, High or Medium power may be used temporarily (in the USA band) by pressing the **H/L** key. When the **PTT** switch released, the transceiver will revert to low power.

5.14 PRESET CHANNELS (1 ~ 8): INSTANT ACCESS

Eight user-assigned channels can be programmed for instant access.

5.14.1 Programming

1. Hold down the **PRESET** key, and press the [▲] or [▼] key (repeatedly, if necessary) until the desired channel number (from among the regular operating channels) is displayed.
2. With the desired channel number displayed, release the **PRESET** key. The “1” notation will appear on the LCD display for 1 second, indicating that the displayed channel is now saved in the Preset Channel “1” position. Then the preset channel number will disappear and the display comes back to the normal channel display.

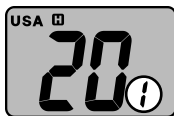

Repeat steps 1 and 2 to program the desired channels into Preset Channels 1 ~ 8.

To delete a Preset Channel, hold down the **PRESET** key and press the [▲] or [▼] key until the Preset Channel number to be deleted is displayed, then release the **PRESET** key.

5.14.2 Operation

Pressing the **PRESET** key toggles between Preset Channel 1, 2, 3, 4, 5, 6, 7, 8 and the last selected “regular” channel. Preset Channel 1 is represented by “1” to the right of the channel number on the LCD for 1 second, and channel 2 is represented by “2,” and so forth. Then the preset channel number will disappear and the display comes back to the normal channel display.

5.15 SIMPLEX/DUPLEX CHANNEL USE

All channels are factory-programmed in accordance with FCC (USA), Industry Canada and International regulations. The mode of operation cannot be altered from simplex to duplex or vice-versa. Simplex or duplex mode is automatically activated, depending on the channel and whether the USA, International or Canadian operating band is selected.

5.16 SETUP MODE

The **HX270S**'s Setup Mode allows a number of the **HX270S** operating parameters to be custom-configured for your operating requirements.

The Setup Mode is easy to activate and set, using the following procedure:

1. Turn the radio off.
2. Hold down the **SQL** key, then turn on the transceiver while still holding down the **SQL** key.
3. "SET" will appear on the display, indicating that the Setup Mode has been activated.
4. Press the **SQL** key to select the Menu item to be adjusted (see below).
5. Press the [▲] or [▼] key select the status or value of the Menu item.
6. After completing your adjustment, press the **SQL** key to save the new setting, and then press the **PTT** switch to exit to normal operation.

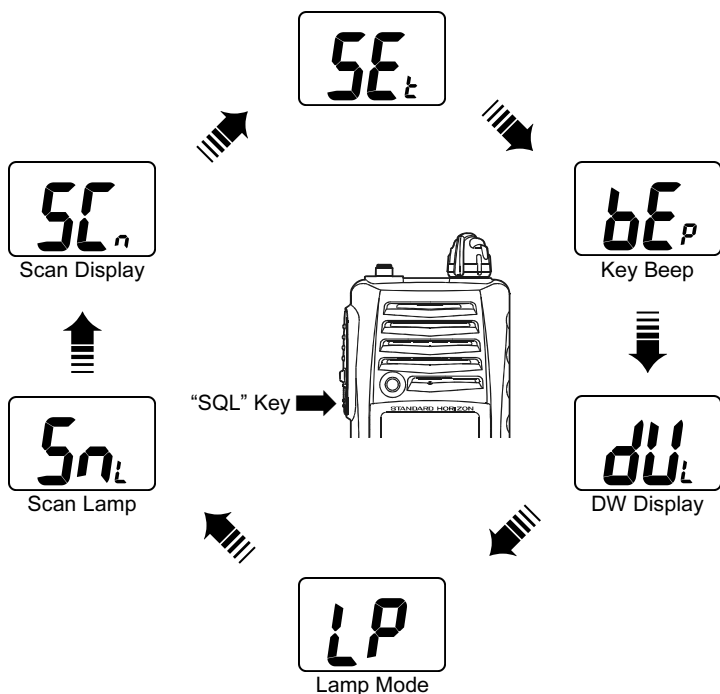

5.16.1 bEP (KEY BEEP)

Function: Enable/Disable the Keypad beeper.

Available Values: ON/OFF

Default: ON

5.16.2 dUL (DW DISPLAY)

Function: Selects the Dual Watch scanning display mode.

Available Values: nor (Normal)/SPL (Special)

Default: SPL (Special)

When “Special” is selected, channel number which is the LCD shows received channel.

5.16.3 LP (LAMP MODE)

Function: Select the LCD/Keypad Lamp mode.

Available Values: kEy (KEY)/Cnt (Continue)/oFf

Default: kEy (KEY)

kEy: Illuminates the LCD/Keypad for 5 seconds when any key is pressed.

Cnt: Illuminates the LCD/Keypad continuously.

oFf: Disables the LCD/Keypad illumination.

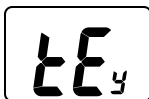

Key

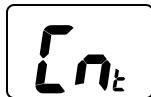

Continue

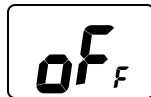

Off

5.16.4 SnL (SCAN LAMP)

Function: Enable/Disable the Scan lamp while scanning is paused.

Available Values: ON/OFF

Default: ON

5.16.5 SCn (SCAN DISPLAY)

Function: Select the display mode while scanning.

Available Values: nor (Normal)/SPL (Special)

Default: nor (Normal)

nor: The channel number changes when scanning.

SPL: The channel number only changes when the radio receives a transmission. This lets you see the last channel on which someone called.



Normal



Special

6. MAINTENANCE

To receive warranty service, the purchaser must deliver the Product, transportation and insurance prepaid, to STANDARD HORIZON Marine Repair Department (a division of VERTEX STANDARD), 10900 Walker Street Cypress, CA 90630. Include proof of purchase indicating model, serial number, and date of purchase. STANDARD HORIZON will return the Product to the purchaser freight prepaid. For general troubleshooting, refer to this Troubleshooting Chart.

TROUBLESHOOTING CHART		
SYMPTOM	PROBABLE CAUSE	REMEDY
The SCAN key does not start the scan.	No channels memorized.	Use the MEM key to enter desired channels into the transceiver's memory.
	Squelch is not adjusted.	Adjust the squelch to threshold or to the point where noise just disappears. Further adjustment of the squelch control may eliminate incoming signals.
The USA/INTL/CAN modes do not function.	Proper operation not followed.	HOLD down the 16/9 key and press the WX key.
Press and holding the SQL key does not eliminate background noise.	Low battery.	Charge battery. Refer to section 3 of this manual.
Cannot change any function.	Key Lock is on.	Turn Key Lock off. Refer to section 4.1. ⑩.
Key Lock does not function.	Proper operation not followed.	Hold down the H/L key for 1 second.
Indicator does not light when charging a battery.	Defective battery FNB-83 or corroded contacts on battery or charger.	Contact your Standard Horizon dealer.

7. PRODUCT SUPPORT INQUIRIES

If you have any questions or comments regarding the use of the **HX270S**, you can visit the STANDARD HORIZON Web site (www.standardhorizon.com), send an E-mail marinetech@vxstdusa.com, or contact the Product Support team at (800)767-2450 M-F 7:00-5:00PST.

8. CHANNEL ASSIGNMENTS

Tables on the following columns list the VHF Marine Channel assignments for U.S.A. and International use. Below are listed some data about the charts.

1. VTS. Where indicated, these channels are part of the U.S. Coast Guard's **Vessel Traffic System**.
2. Alpha channel numbers, that is, channel numbers followed by the letter A (such as Channel 07A) are **simplex** channels on the U.S.A. or Canadian channel assignments whose counterparts in the International assignments are **duplex** channels. International channels do not use "Alpha" numbers. If you call the Coast Guard on Channel 16, they will sometimes ask you to "**go to channel 22 Alpha**." This is a channel assigned to U.S.A, and Canadian Coast Guards for handling distress and other calls. If your radio is set for **International** operation you will go to Channel 22 instead of 22A, and will not be able to communicate with the Coast Guard. To use Channel 22A, your radio must be set for **USA** or **Canada** operation, usually by a U/I/C (USA/International/Canada) control or combination of controls. Channel 22 (without an "A" is an **International** duplex channel for port operations. Some radios indicate an "A" adjacent to the alpha channels on the display; on others "Alpha" is not indicated but the proper channel is selected based on the U/I/C setting.
3. Bridge-to-Bridge channels (for example, Channel 13) are for use by bridge operators on intercoastal waterways and rivers. It is also used by marine vessels in the vicinity of these bridges for navigation and for communicating with the bridge operators. Note that a limit of 1 Watt is specified for these channels. See page 22 for additional information.
4. The **S/D** column on the chart indicates either S (simplex) or D (duplex). **Simplex** means transmitting and receiving on the same frequency. Only one party at a time can talk, unlike a telephone. Be sure to say "**over**" and release your microphone push-to-talk switch at the end of each transmission. **Duplex** operation involves the use of one frequency for transmitting and a separate frequency for receiving. On channels specified

as duplex on the charts, correct mode of operation is established automatically by your radio when you select a channel; you cannot change the mode. And you still must release the push-to-talk switch after each transmission in order to listen to the radio.

- Channels normally used by recreational boaters are those that include the term “non-commercial” in the Channel Use column of the chart. Some of these are shared with other users and some are used only in certain geographic regions.
- Marine vessels equipped with VHF radios are required to monitor Channel 16.**

VHF Marine Channel

VHF MARINE CHANNEL CHART							
CH	U	C	I	S/D	TX	RX	CHANNEL USE
01		X	X	D	156.050	160.650	Public Correspondence (Marine Operator)
01A	X			S	156.050		Port Operation and Commercial. VTS in selected areas
02		X	X	D	156.100	160.700	Public Correspondence (Marine Operator)
03		X	X	D	156.150	160.750	Public Correspondence (Marine Operator)
03A	X			S		156.150	US Government only, Coast Guard
04			X	D	156.200	160.800	Public Correspondence (Marine Operator), Port operation, ship movement
04A		X		S	156.200		Pacific coast: Coast Guard, East Coast: Commercial fishing
05			X	D	156.250	160.850	Public Correspondence (Marine Operator), Port operation, ship movement
05A	X	X		S	156.250		Port operation. VTS in Seattle
06	X	X	X	S	156.300		Inter-ship Safety
07			X	D	156.350	160.950	Public Correspondence (Marine Operator), Port operation, ship movement
07A	X	X		S	156.350		Commercial
08	X	X	X	S	156.400		Commercial (Inter-ship only)
09	X	X	X	S	156.450		Boater Calling channel, Commercial & Non-commercial (Recreational)
10	X	X	X	S	156.500		Commercial
11	X	X	X	S	156.550		Commercial. VTS in selected areas.
12	X	X	X	S	156.600		Port operation. VTS in selected areas.
13	X	X	X	S	156.650		Inter-ship Navigation Safety (Bridge-to-bridge)
14	X	X	X	S	156.700		Port operation. VTS in selected areas.
15	X			S	- - -	156.750	Environmental (Receive only)
15		X	X	S	156.750		Commercial, non-commercial, ship movement (1 W)
16	X	X	X	S	156.800		International Distress, Safety and Calling
17	X	X	X	S	156.850		State Controlled (1 W)
18			X	D	156.900	161.500	Port operation, ship movement
18A	X	X		S	156.900		Commercial
19			X	D	156.950	161.550	Port operation, ship movement
19A	X			S	156.950		US: Commercial
19A		X		S	156.950		Coast Guard

VHF MARINE CHANNEL CHART							
CH	U	C	I	S/D	TX	RX	CHANNEL USE
20	X	X	X	D	157.000	161.600	Canadian Coast Guard Only, International: port operations and shipment
20A	X			S	157.000		Port operation
21			X	D	157.050	161.650	Port operation, ship movement
21A	X	X		S	157.050		U.S. Government Only, Canadian Coast Guard
22			X	D	157.100	161.700	Port operation, ship movement
22A	X	X		S	157.100		US and Canadian Coast Guard Liaison and Maritime Safety Information Broadcasts announced on channel 16
23		X	X	D	157.150	161.750	Public Correspondence (Marine Operator)
23A	X			S	157.150		U.S. Government Only
24	X	X	X	D	157.200	161.800	Public Correspondence (Marine Operator)
25	X	X	X	D	157.250	161.850	Public Correspondence (Marine Operator)
26	X	X	X	D	157.300	161.900	Public Correspondence (Marine Operator)
27	X	X	X	D	157.350	161.950	Public Correspondence (Marine Operator)
28	X	X	X	D	157.400	162.000	Public Correspondence (Marine Operator)
60		X	X	D	156.025	160.625	Public Correspondence (Marine Operator)
61			X	D	156.075	160.675	Public Correspondence (Marine Operator), Port operation, ship movement
61A	X	X		S	156.075		U.S. Government Only, Canadian Coast Guard- Pacific Coast, Commercial Fishing-East Coast
62			X	D	156.125	160.725	Public Correspondence (Marine Operator), Port operation, ship movement
62A		X		S	156.125		Public Coast: Coast Guard; East Coast: commercial fishing only
63			X	D	156.175	160.775	Public Correspondence (Marine Operator), Port operation, ship movement
63A	X			S	156.175		Port Operation and Commercial. VTS in selected areas.
64		X	X	D	156.225	160.825	Public Correspondence (Marine Operator), Port operation, ship movement
64A	X	X		S	156.225		U.S. Government Only, Canadian Commercial Fishing
65			X	D	156.275	160.875	Public Correspondence (Marine Operator), Port operation, ship movement
65A	X	X		S	156.275		Port Operations
66			X	D	156.325	160.925	Public Correspondence (Marine Operator), Port operation, ship movement
66A	X	X		S	156.325		Port Operations
67	X	X	X	S	156.375		US: Commercial. Used for Bridge-to-bridge commu- nications in lower Mississippi River. Inter-ship only, Canada: Commercial fishing, S&R
68	X	X	X	S	156.425		Non-commercial (Recreational)
69	X	X	X	S	156.475		US: Non-commercial (Recreational), Canada: Commercial fishing only, International: Inter-ship, Port operations and Ship movement
70	X	X	X	S	156.525		Digital selective calling (voice communications not allowed)
71	X	X	X	S	156.575		US, Canada: Non-commercial (Recreational), International: Port operations and Ship movement
72	X	X	X	S	156.625		Non-commercial (Inter-ship only)
73	X	X	X	S	156.675		US: Port Operations, Canada: Commercial fishing only, International: Inter-ship, Port operations and Ship movement

VHF MARINE CHANNEL CHART							
CH	U	C	I	S/D	TX	RX	CHANNEL USE
74	X	X	X	S	156.725		US: Port Operations, Canada: Commercial fishing only, International: Inter-ship, Port operations and Ship movement
75	X			S	156.775		Port Operations (Inter-ship only) (1W)
76	X			S	156.825		Port Operations (Inter-ship only) (1W)
77	X	X		S	156.875		Port Operations (Inter-ship only) (1W)
77			X	S	156.875		Port Operations (Inter-ship only)
78			X	D	156.925	161.525	Public Correspondence (Marine Operator), Port operation, ship-movement
78A	X	X		S	156.925		Non-commercial (Recreational)
79			X	D	156.975	161.575	Port operation and Ship movement
79A	X	X		S	156.975		Commercial
80			X	D	157.025	161.625	Port operation, ship movement
80A	X	X		S	157.025		Commercial
81			X	D	157.075	161.675	Port operation, ship movement
81A	X	X		S	157.075		U.S. Government Only - Environmental protection operations.
82			X	D	157.125	161.725	Public Correspondence (Marine Operator), Port operation, ship movement
82A	X	X		S	157.125		U.S. Government Only, Canadian Coast Guard Only
83	X	X	X	D	157.175	161.775	Canadian Coast Guard Only
83A	X	X		S	157.175		U.S. Government Only, Canadian Coast Guard Only
83		X	X	D	157.175	161.775	Public Correspondence (Marine Operator)
84	X	X	X	D	157.225	161.825	Public Correspondence (Marine Operator)
85	X	X	X	D	157.275	161.875	Public Correspondence (Marine Operator)
86	X	X	X	D	157.325	161.925	Public Correspondence (Marine Operator)
87	X	X	X	D	157.375	161.975	Public Correspondence (Marine Operator)
88	X	X	X	D	157.425	162.025	Public Correspondence (ship-to-coast)
88A	X			S	157.425		Commercial, Inter-ship Only
WX01	X	X	X	D	---	162.550	Weather (receive only)
WX02	X	X	X	D	---	162.400	Weather (receive only)
WX03	X	X	X	D	---	162.475	Weather (receive only)
WX04	X	X	X	D	---	162.425	Weather (receive only)
WX05	X	X	X	D	---	162.450	Weather (receive only)
WX06	X	X	X	D	---	162.500	Weather (receive only)
WX07	X	X	X	D	---	162.525	Weather (receive only)
WX08	X	X	X	D	---	161.650	Weather (receive only)
WX09	X	X	X	D	---	161.775	Weather (receive only)
WX10	X	X	X	D	---	163.275	Weather (receive only)

The above **BOLD** channels are not for use of the general public in U.S. waters, unless proper authorization is given.

Channel designator	Carrier frequency (MHz)		Points of communication (Intership and between coast and ship unless otherwise indicated)	
	Ship transmit	Coast transmit		
Port Operations				
01A ¹	156.050	156.050		
63A ¹	156.175	156.175		
05A ²	156.250	156.250		
65A	156.275	156.275		
66A	156.325	156.325		
12 ³	156.600	156.600		
73	156.675	156.675		
14 ³	156.700	156.700		
74	156.725	156.725		
77 ⁴	156.875			
20A ¹²	157.000			
Navigational (Bridge-to-Bridge)⁵				
13 ⁶	156.650	156.650		
67 ⁷	156.375	156.375		
Commercial				
01A ¹	156.050	156.050	Intership only. Do.	
63A ¹	156.175	156.175		
07A	156.350	156.350		
67 ⁷	156.375		
08	156.400		
09	156.450	156.450		
10	156.500	156.500		
11 ³	156.550	156.550		
18A	156.900	156.900		
19A	156.950	156.950		
79A	156.975	156.975		
80A	157.025	157.025		
88A ⁸	157.425		
72 ¹⁴	156.625		
Digital Selective Calling				
70 ¹⁵	156.525	156.525		
Noncommercial				
68 ¹⁷	156.425	156.425	Intership only. Great Lakes only. Do. Internship only.	
09 ¹⁶	156.450	156.450		
69	156.475	156.475		
71	156.575	156.575		
72	156.625		
78A	156.925	156.925		
79A	156.975	156.975		
80A	157.025	157.025		
67 ¹⁴	156.375		

Channel designator	Carrier frequency (MHz)		Points of communication (Intership and between coast and ship unless otherwise indicated)
	Ship transmit	Coast transmit	
Distress, Safety and Calling			
16	156.800	156.800	EPRI B
Intership Safety			
06	156.300	a. Intership, or b. For SAR: Ship and aircraft for the U.S. Coast Guard.
Environmental			
15 ¹³	156.750	Coast to ship only.
Maritime Control			
17 ^{9,10}	156.850	156.850	
Liaison, U.S. Coast Guard			
22A ¹¹	157.100	157.100	Ship, aircraft, and coast stations of the U.S. Coast Guard and at Lake Mead, Nev., ship and coast stations of the National Park Service, U.S. Department of the Interior.
Public Correspondence (Marine Operator) channels			
24	157.200	161.800	
84	157.225	161.825	
25	157.250	161.850	
85	157.275	161.875	
26	157.300	161.900	
86	157.325	161.925	
27	157.350	161.950	
87	157.375	161.975	
28	157.400	162.000	
88 ⁸	157.425	162.025	

1. 156.050 MHz and 156.175 MHz are available for port operations and commercial communications purposes when used only within the U.S. Coast Guard designated Vessel Traffic Services (VTS) area of New Orleans, on the lower Mississippi River from the various pass entrances in the Gulf of Mexico to Devil's Swamp Light at River Mile 242.4 above head of passes near Baton Rouge.
2. 156.250 MHz is available for port operations communications use only within the U.S. Coast Guard designated VTS radio protection areas of New Orleans and Houston described in Sec. 80.383. 156.250 MHz is available for intership port operations communications used only within the area of Los Angeles and Long Beach harbors, within a 25- nautical mile radius of Point Fermin, California.
3. 156.550 MHz, 156.600 MHz and 156.700 MHz are available in the U.S. Coast Guard designated port areas only for VTS communications and in the Great Lakes available primarily for communications relating to the movement of ships in sectors designated by the St. Lawrence Seaway Development Corporation or the U.S. Coast Guard. The use of these frequencies outside VTS and ship movement sector protected areas is permitted provided they cause no interference to VTS and ship movement communications in thier respective designated sectors.
4. Use of 156.875 MHz is limited to communications with pilots regarding the movement and docking of ships. Normal output power must not exceed 1 watt.
5. 156.375 MHz and 156.650 MHz are available primarily for intership navigational communications. These frequencies are available between coast and ship on a secondary basis when used on or in the vicinity of locks or drawbridges. Normal output power must not exceed 1 watt. Maximum output power must not exceed 10 watts for coast stations or 25 watts for ship stations.
6. On the Great Lakes, in addition to bridge-to-bridge communications, 156.650 MHz is available for vessel control purposes in established vessel traffic systems. 156.650 MHz is not available for use in the Mississippi River from South Pass Lighted Whistle Buoy "2" and Southwest Pass entrance Midchannel Lighted Whistle Buoy to mile 242.4 above Head of Passes near Baton Rouge. Additionally it is not available for use in the Mississippi River-Gulf Outlet, the Mississippi River-Gulf Outlet Canal, and the Inner Harbor Navigational Canal, except to aid the transition from these areas.
7. Use of 156.375 MHz is available for navigational communications only in the Mississippi River from South Pass Lighted Whistle Buoy "2" and Southwest Pass entrance Mid-channel Lighted Whistle Buoy to mile 242.4 above head of Passes near Baton Rouge, and in addition over the full length of the Mississippi River-Gulf Outlet Canal from entrance to its junction with the Inner Harbor Navigation Canal, and over the ull length of the Inner Harbor Navigation Canal from its junction with the Mississippi River to its entry to Lake Pontchartrain at the New Seabrook vehicular bridge.

8. Within 120 km (75 miles) of the United States/Canada border, in the area of the Puget Sound and the Strait of Juan de Fuca and its approaches, 157.425 MHz is half of the duplex pair designated as Channel 88. In this area, Channel 88 is available to ship stations for communications with public coast stations only. More than 120 km (75 miles) from the United States/Canada border in the area of the Puget Sound and the Strait of Juan de Fuca, its approaches, the Great Lakes, and the St. Lawrence Seaway, 157.425 MHz is available for intership and commercial communications. Outside Puget Sound area and its approaches and the Great Lakes, 157.425 MHz is also available for communications between commercial fishing vessels and associated aircraft while engaged in commercial fishing activities.
9. When the frequency 156.850 MHz is authorized, it may be used additionally for search and rescue training exercises conducted by state or local governments.
10. The frequency 156.850 MHz is additionally available to coast stations on the Great Lakes for transmission of scheduled Coded Marine Weather Forecasts (MAFOR), Great Lakes Weather Broadcast (LAWEB) and scheduled Notices to Mariners or Bulletins. F3C and J3C emissions are permitted. Coast Stations on the Great Lakes must cease weather broadcasts which cause interference to stations operating on 156.800 MHz until the interference problem is resolved.
11. The frequency 157.100 MHz is authorized for search and rescue training exercises by state or local government in conjunction with U.S. Coast Guard stations. Prior U.S. Coast Guard approval is required. Use must cease immediately on U.S. Coast Guard request.
12. The duplex pair for channel 20 (157.000/161.600 MHz) may be used for ship to coast station communications.
13. Available for assignment to coast stations, the use of which is in accord with an agreed program, for the broadcast of information to ship stations concerning the environmental conditions in which vessels operate, i.e., weather; sea conditions; time signals; notices to mariners; and hazards to navigation.
14. Available only in the Puget Sound and the Strait of Juan de Fuca.
15. The frequency 156.525 MHz is to be used exclusively for distress, safety and calling using digital selective calling techniques. No other uses are permitted.
16. The frequency 156.450 MHz is available for intership, ship and coast general purpose calling by noncommercial vessels, such as recreational boats and private coast stations.
17. The frequency 156.425 MHz is assigned by rule to private coast stations in Alaska for facsimile transmissions as well as voice communications.

9. WARRANTY

Marine Products Limited Warranty

STANDARD HORIZON (a division of VERTEX STANDARD) warrants, to the original purchaser only, each new Marine Communications Product ("Product") manufactured and/or supplied by STANDARD HORIZON against defects in materials and workmanship under normal use and service for a period of time from the date of purchase as follows:

3 years Waterproof - if purchased after 01/01/94

Associated Chargers

3 years - if purchased after 01/01/91

Associated Batteries - 1 year. Note: Batteries will be deemed defective only if storage capacity drops below 80% of rated capacity or if leakage develops.

Associated Accessories - 1 year. Includes: Microphones/Handsets, External Speakers, Antennas, Carrying Accessories, Power Supplies, and Signaling Boards.

In the event of a defect, malfunction or failure of the Product during the warranty period, STANDARD HORIZON's liability for any breach of contract or any breach of express or implied warranties in connection with the sale of Products shall be limited solely to repair or replacement, at its option, of the Product or part(s) therein which, upon examination by STANDARD HORIZON, appear to be defective or not up to factory specifications. STANDARD HORIZON may, at its option, repair or replace parts or subassemblies with new or reconditioned parts and subassemblies. Parts thus repaired or replaced are warranted for the balance of the original applicable warranty.

STANDARD HORIZON will not warrant installation, maintenance or service of the Products. In all instances, STANDARD HORIZON's liability for damages shall not exceed the purchase price of the defective Product.

This warranty only extends to Products sold within the 50 States of the United States of America and the District of Columbia.

STANDARD HORIZON will pay all labor to repair the product and replacement parts charges incurred in providing the warranty service except where purchaser abuse or other qualifying exceptions exist. The purchaser must pay any transportation expenses incurred in returning the Product to STANDARD HORIZON for service.

This limited warranty does not extend to any Product which has been subjected to misuse, neglect, accident, incorrect wiring by anyone other than STANDARD HORIZON, improper installation, or subjected to use in violation of instructions furnished by STANDARD HORIZON, nor does this warranty extend to Products on which the serial number has been removed, defaced, or changed. STANDARD HORIZON cannot be responsible in any way for ancillary equipment not furnished by STANDARD HORIZON which is attached to or used in connection with STANDARD HORIZON's Products, or for the operation of the Product with any ancillary equipment and all such equipment is expressly excluded from this warranty. STANDARD HORIZON disclaims liability for range, coverage, or operation of the Product and ancillary equipment as a whole under this warranty. STANDARD HORIZON reserves the right to make changes or improvements in Products, during subsequent production, without incurring the obligation to install such changes or improvements on previously manufactured Products.

The implied warranties which the law imposes on the sale of this Product are expressly LIMITED, in duration, to the time period specified above. STANDARD HORIZON shall not be liable under any circumstances for consequential damages resulting from the use and operation of this Product, or from the breach of this LIMITED WARRANTY, any implied warranties, or any contract with STANDARD HORIZON. IN CONNECTION WITH THE SALE OF ITS PRODUCTS, STANDARD HORIZON MAKES NO WARRANTIES, EXPRESS OR IMPLIED AS TO THE MERCHANTABILITY OR FITNESS FOR A PARTICULAR PURPOSE OR OTHERWISE, EXCEPT AS EXPRESSLY SET FORTH HEREIN.

Some states do not allow the exclusion or limitation of incidental or consequential damages, or limitation on how long an implied warranty lasts, so the above limitations or exclusions may not apply. This warranty gives specific legal rights, and there may be other rights which may vary from state to state.

ONLY PRODUCTS SOLD ON OR AFTER JANUARY 1, 1991 ARE COVERED UNDER THE TERMS OF THIS LIMITED WARRANTY.

In addition to the warranty, STANDARD HORIZON includes a lifetime "flat rate" program to provide service after the warranty period has expired. If you wish to obtain the flat rate price for out-of-warranty repair, you must include the information on the Owner's Record with the unit when you return it to STANDARD HORIZON.

Note: The flat rate amount is payable by the Owner only if STANDARD HORIZON or the STANDARD HORIZON Dealer determines that a repair is needed. After the repair, a 90-day warranty will be in effect from the date of return of the unit to the Owner.

This service program is not available for equipment which has failed as a result of neglect, accident, breakage, misuse, improper installation or modification.

ON-LINE WARRANTY REGISTRATION

Please visit www.standardhorizon.com to register the **HX270S** Marine VHF. It should be noted that visiting the Web site from time to time may be beneficial to you, as new products are released they will appear on the STANDARD HORIZON Web site.

10. SPECIFICATIONS

7.1 General

Frequency range:	156 MHz - 163.275 MHz (Marine Band + WX Band) Channel Steps: 25 kHz
Frequency stability:	± 5 ppm (-22 °F to +140 °F [-30 °C to +60 °C])
Emission type:	16K0G3E
Antenna impedance:	50 Ohms
Supply voltage:	7.2 VDC
Current consumption:	200 mA (Receive) 40 mA (Standby, Saver Off) TX: 1.4 A (H)/0.9 A (M)/0.5 A (L)
Operating Temperature:	-22 °F to +140 °F (-30 °C to +60 °C)
Waterproof rating:	30 minutes @ 1 meter depth (JIS 7)
Case Size (W x H x D):	2.3" x 4.7" x 1.2" (58 x 120 x 30.5 mm)
Weight (Approx):	13.4 oz (380 g) with FNB-83

7.2 Transmitter

RF output power:	5 W/2.5 W/1 W @7.2 V
Modulation Type:	Variable Reactance
Max deviation:	±5 kHz
Spurious emissions:	At least 73 dB down

7.3 Receiver

Circuit type:	Double-conversion superheterodyne
Intermediate Frequencies:	1st: 21.7 MHz 2nd: 450 kHz
Sensitivity:	0.25 µV 12 dB SINAD
Adjacent channel selectivity:	70 dB
Intermodulation response:	70 dB
Selectivity:	12 kHz / 25 kHz (-6 dB/-60 dB)
AF output:	600 mW @ 16 Ohm for 10 % THD (@7.2V)

This device complies with part 15 of the FCC rules. Operation is subject to the condition that this device does not cause harmful interference.

Part 15.21: Changes or modifications to this device not expressly approved by Vertex Standard could void the User's authorization to operate this device.





**Marine Division of VERTEX STANDARD
US Headquarters**

10900 Walker Street, Cypress, CA 90630, U.S.A.

www.standardhorizon.com



E M O O 7 N 1 0 0

Copyright 2004
VERTEX STANDARD CO., LTD.
All rights reserved.

No portion of this manual
may be reproduced
without the permission of
VERTEX STANDARD CO., LTD.

Printed in Japan