

# LOWRANCE®

www.lowrance.com

Pub. 988-0152-221



## GlobalMap® 5150c Mapping GPS Receiver Operation Instructions

**Copyright © 2006 Lowrance Electronics, Inc.  
All rights reserved.**

No part of this manual may be copied, reproduced, republished, transmitted or distributed for any purpose, without prior written consent of Lowrance. **Any unauthorized commercial distribution of this manual is strictly prohibited.**

Lowrance® is a registered trademark of Lowrance Electronics, Inc. MapCreate™, FreedomMaps™ and NauticPath™ are trademarks of LEI. Fishing Hot Spots® is a registered trademark of Fishing Hot Spots Inc. LakeMaster® and Pro Maps are trademarks or registered trademarks of WayPoint Technologies, Inc. Navionics® is a registered trademark of Navionics, Inc. DURACELL® is a registered trademark of Duracell, Inc. RAYOVAC® is a registered trademark of Rayovac Corporation. Energizer® and e2® are registered trademarks of Energizer Holdings, Inc.



Points of Interest Data in this unit are by infoUSA, copyright © 2001-2006, All Rights Reserved. infoUSA is a trademark of infoUSA, Inc.

Lowrance Electronics may find it necessary to change or end our policies, regulations and special offers at any time. We reserve the right to do so without notice. All features and specifications subject to change without notice. On the cover: GlobalMap 5150c. All screens in this manual are simulated.

**For free owner's manuals and the most current information on  
this product, its operation and accessories,  
visit our web site:  
[www.lowrance.com](http://www.lowrance.com)**

Lowrance Electronics Inc.  
12000 E. Skelly Dr.  
Tulsa, OK USA 74128-2486  
Printed in USA.

# Table of Contents

<b>Section 1: Read Me First!</b> .....	<b>1</b>
Capabilities and Specifications: GlobalMap 5150c.....	2
How GPS Works.....	4
Introduction to GPS and WAAS.....	6
How to use this manual: typographical conventions.....	8
Arrow Keys.....	8
Keyboard.....	8
Menu Commands.....	8
Instructions = Menu Sequences.....	8
<b>Section 2: Installation &amp; Accessories</b> .....	<b>11</b>
Preparations.....	11
GPS Antenna/Receiver Module Installation.....	11
Power Connections.....	12
NMEA Cable Connections.....	14
NMEA Wiring.....	15
Mounting the Unit: Bracket, In-Dash or Portable.....	15
MMC or SD Card Memory Card Installation.....	19
Cleaning Towel.....	20
Face Cover.....	21
<b>Section 3: Basic GPS Operations</b> .....	<b>23</b>
Keyboard.....	23
Power/lights on and off.....	24
Main Menu.....	24
Pages.....	26
Satellite Status Page.....	26
Navigation Page.....	28
Map Page.....	31
Background map vs. MapCreate map content.....	33
Map with Custom Gauges.....	35
Resize Window command.....	37
Choose Viewable Pages.....	38
Basic GPS Quick Reference.....	39
Find Your Current Position.....	40
Moving Around the Map: Zoom & Cursor Arrow Keys.....	40
Selecting Any Map Item with the Cursor.....	41
Searching.....	41
Set a Waypoint.....	44
Navigate To a Waypoint.....	46
Set Man Overboard (MOB) Waypoint.....	47
Navigate Back to MOB Waypoint.....	47
Navigate to Cursor Position on Map.....	48

Navigate to a Point of Interest.....	50
Creating and Saving a Trail.....	50
Displaying a Saved Trail.....	52
Navigating Trails.....	52
Transfer Custom Maps and GPS Data Files.....	56
Cancel Navigation.....	58
<b>Section 4: Advanced GPS Operations.....</b>	<b>59</b>
Find Distance from Current Position To Another Location.....	59
Find Distance from Point to Point.....	59
Icons.....	60
Create Icon on Map.....	60
Create Icon at Current Position.....	60
Delete an Icon.....	61
Navigate to an Icon.....	61
Routes.....	61
Create and Save a Route.....	62
Delete a Route.....	65
Edit a Route Name.....	65
Edit Route Waypoints.....	65
Navigate a Route.....	66
Navigate a Route in Reverse.....	67
Trails.....	68
Delete a Trail.....	68
Edit a Trail Name.....	69
Edit a Trail Color.....	69
Edit a Trail Pattern.....	69
Utilities.....	70
Alarm Clock.....	70
Sun/Moon Rise & Set Calculator.....	70
Trip Calculator.....	70
Trip Down Timer.....	70
Trip Up Timer.....	70
Waypoints.....	70
Delete a Waypoint.....	70
Edit a Waypoint.....	71
Selecting a Waypoint.....	72
Set a Waypoint by Average Position.....	72
Set a Waypoint by Projecting a Position.....	72
<b>Section 5: System &amp; GPS Setup Options.....</b>	<b>73</b>
Alarms.....	73
Check MMC Files and Storage Space.....	74
Communications Port Configuration.....	74
Configure NMEA.....	75

Coordinate System Selection.....	76
Customize Page Displays .....	78
GPS Simulator.....	79
Initialize GPS .....	80
Map Auto Zoom .....	80
Map Data .....	81
Show Map Data .....	81
Pop-up Map Information.....	81
Map Boundaries .....	81
Fill Water With White .....	82
Map Datum Selection .....	82
Map Detail Category Selection .....	83
Map Fix.....	84
Map Orientation.....	85
NauticPath™ USA Marine Charts.....	86
Navionics® Charts.....	91
Overlay Data .....	92
Pop-up Help.....	94
Reset Options .....	95
Require WAAS.....	95
Screen Contrast and Brightness .....	96
Set Language.....	97
Set Local Time.....	97
Show WAAS Alarm .....	98
Software Version Information.....	98
Sounds and Alarm Sound Styles.....	99
Track Smoothing.....	99
Trail Options .....	100
Delete All Trails .....	100
Update Trail Option .....	101
Delete Trail .....	102
New Trail .....	102
Trail Visible/Invisible and Other Trail Options .....	102
Transparency.....	102
Units of Measure.....	103
<b>Section 6: Searching.....</b>	<b>104</b>
Find Addresses .....	106
Find Any Item Selected by Map Cursor .....	109
Find Interstate Highway Exits .....	109
Find Map Places or Points of Interest (POI) .....	112
Find Streets or Intersections.....	114
Find Waypoints .....	118
<b>Section 10: Supplemental Material .....</b>	<b>121</b>

***NOTICE!***

The storage and operation temperature range for your unit is from -20 degrees to +167 degrees Fahrenheit (-28 degrees to +75 degrees Celsius). *Extended storage or operation in temperatures higher or lower than specified will damage the liquid crystal display in your unit. This type of damage is not covered by the warranty.* For more information, contact the factory's Customer Service Department; phone numbers are listed on the last page of the manual.

**WARNING!**

**A CAREFUL NAVIGATOR NEVER RELIES ON ONLY ONE METHOD TO OBTAIN POSITION INFORMATION.**

***CAUTION***

*When showing navigation data to a position (waypoint), a GPS unit will show the shortest, most direct path to the waypoint. It provides navigation data to the waypoint regardless of obstructions. Therefore, the prudent navigator will not only take advantage of all available navigation tools when traveling to a waypoint, but will also visually check to make sure a clear, safe path to the waypoint is always available.*

**WARNING!**

**When a GPS unit is used in a vehicle, the vehicle operator is solely responsible for operating the vehicle in a safe manner. Vehicle operators must maintain full surveillance of all pertinent driving, boating or flying conditions at all times. An accident or collision resulting in damage to property, personal injury or death could occur if the operator of a GPS-equipped vehicle fails to pay full attention to travel conditions and vehicle operation while the vehicle is in motion.**

# Section 1: Read Me First!

## *How this manual can get you out on the road, fast!*

Welcome to the exciting world of digital GPS! We know you're anxious to begin navigating, but we have a favor to ask. Before you grab the GlobalMap 5150c and begin installing it, please give us a moment or two to explain how our manual can help you get the best performance from your compact, wide-screen, mapping GPS receiver.

First, we want to thank you for buying an Lowrance GPS unit. Whether you're a first time user or a professional fisherman, you'll discover that your GlobalMap 5150c is easy to use, yet capable of handling demanding navigation tasks. When you team your unit with our custom mapping software MapCreate™, you have an incredible combination. You won't find another GPS unit with this much power and this many features for this price!

Our goal for this book is to get you on the road fast, with a minimum of fuss. Like you, we'd rather spend more time navigating and less time reading the manual!

So, we designed our book so that you *don't* have to read the *whole thing* from front to back for the information you want. At the start (or end) of each segment, we'll tell you what content is coming up next. If it's a concept you're already familiar with, we'll show you how and where to skip ahead for the next important topic. We've also made it easy to look up any tips you may need from time to time. Here's how:

The manual is organized into 7 sections. This first section is an introduction to Lowrance GPS. It tells you the basics you need to know before you can make the unit look around and tell you where you are.

Section 2 will help you install your unit. We'll show you how to get the MultiMedia Card (MMC) correctly installed inside the unit. We'll also tell you about some of the available accessories.

Section 3 covers *Basic GPS Operation*. It will show you how easy it is to run the GlobalMap 5150c, right out of the box. This section features a one-page GPS Quick Reference. **(If you've already jumped ahead and figured out how to install the unit yourself, and you just *can't* wait any longer, turn to the Quick Reference on page 39 and head for the road with your GPS unit!)**

Section 3 contains short, easy-to-scan GPS lessons that follow one another in chronological order. They're all you'll need to know to find your way on the water or in the wilderness quickly.

After you've learned the basics (or if you already have some GPS experience), you may want to try out some of the GlobalMap 5150c many advanced navigation features. That brings us to Section 4, *Advanced GPS Operations*. This section contains the rest of the unit's GPS command functions, organized in alphabetical order.

When you come to a GPS menu command on the GlobalMap 5150c screen, you can look it up in the manual by skimming over the table of contents, just flipping through Section 3 or scanning through the command portion of Section 4.

This unit is ready to use right out of the box, but you can fine tune and customize its operation with dozens of options. We describe how to use general system options along with GPS options in Section 5, *System Setup and GPS Setup Options*. Section 5 is organized in alphabetical order.

In Section 6, we go into more detail on one of the GlobalMap 5150c most remarkable capabilities — Searching. We'll introduce a search example in the Basic GPS Operation section, but there are so many map items you can search for, we had to give this function its own section in the manual! For example, did you know this unit can look up business phone numbers, functioning as a virtual Yellow Pages? We'll show you how in Section 6.

Finally, in Section 7, we offer *Supplemental Material*, including a list of the GPS datums used, warranties and customer service information.

Now, if you're into the fine details, glance over the next segment on specifications to see just how much GPS power your GlobalMap 5150c contains. It's important to *us* (and our power users), but, if *you* don't care how many watts of power the unit has, or how many waypoints it can store, skip ahead to important information on how our GPS works, on page 4.

## Capabilities and Specifications: GlobalMap 5150c

### General

- Display:** .....5.0" (12.7 cm) diagonal 256-color TFT LCD; programmable to viewing preference.
- Resolution:** .....640V x 480H pixel resolution; 307,200 total pixels.
- Backlighting:** .....Backlit screen and keypad with multiple lighting levels for night use.
- Input power:** .....10 to 15 volts DC.
- Current drain:** .....With lights on: 700 ma.



- Case size:** .....5.4" H x 6.9" W x 3.4" D (13.8 x 17.6 x 8.6 cm); sealed and waterproof; suitable for salt-water use.
- MMC slots:**.....Two, with waterproof door (SD card compatible).
- Recording:**.....MMC & SD cards for recording GPS trip details and displaying charts or custom maps.
- Back-up memory:**.....Built-in memory stores GPS data for decades. User settings are stored when unit is turned off.
- Languages:** .....10; menu languages selectable by user.

**GPS**

- Receiver/antenna:** .....External LGC-12w GPS/WAAS antennal module .
- Background map:** .....Built-in custom, detailed Lowrance map. Contains: enhanced detail of continental U.S. and Hawaii. Includes more than 60,000 nav aids and 10,000 wrecks/obstructions in coastal and Great Lakes waters. Metro areas, selected major streets/highways and interstate exit services details included.
- Custom mapping:**.....MapCreate software optional; optional plug and play LEI FreedomMaps™ offer the same high-detail without the computer work of MapCreate. Other plug and play mapping options include Fishing Hot Spots®, Lake-Master® Pro Maps, LEI NauticPaths™ charts and Navionics® charts.
- Mapping memory:** .....Up to 1 gigabyte on one MMC (or SD) card.
- Position updates:**.....Every second.
- Position points:**.....1,000 waypoints; 1,000 event marker icons.
- Audible alarms:**.....Arrival/off-course/anchor.
- Graphic symbols for waypoints or event marker icons:**.....42.
- Routes:** .....100, up to 100 waypoints per route.
- Plot Trails:**.....10 savable; up to 10,000 points per trail.
- Zoom range:** .....40 ranges; 0.02 to 4,000 miles.

**NOTE:**

The above memory capacities refer only to the GlobalMap's on-board memory. The amount of GPS data you can record and save for recall later is limited only by the number and size of MMC cards you have.

**NOTICE!**

The storage temperature range for your GlobalMap 5150c is from -4 degrees to +167 degrees Fahrenheit (-20 degrees to +75 degrees Celsius). *Extended storage in temperatures higher or lower than specified will damage the liquid crystal display in your unit. This type of damage is not covered by the warranty.* For more information, contact the factory's Customer Service Department; phone numbers are listed on the last page of this manual.

**How GPS Works**

You'll navigate faster and easier if you understand how the GlobalMap 5150c scans the sky to tell you where you are on the earth – and, where you're going. But if you already have a working understanding of GPS receivers and the GPS navigation system, skip on ahead to Section 2, *Installation & Accessories* on page 11. If you're new to GPS, read on. You can later impress your friends with your new-found knowledge.

First, think of your unit as a small but powerful computer. But don't worry — we made it easy to use, so you don't need to be a computer expert to find your way! The GlobalMap 5150c includes a keypad and a screen with menus so you can tell it what to do. The screen also lets the unit show your location on a moving map, as well as point the way to your destination.

This gimbal-mounted GlobalMap 5150c uses an internal antenna/receiver module, which makes the whole system work something like your car radio. But instead of your favorite dance tunes, this receiver tunes in to a couple of dozen GPS satellites circling the earth. It will also listen in to the WAAS satellites in orbit, but more about that in the upcoming segment introducing you to GPS and WAAS.

Your unit listens to signals from as many satellites as it can "see" above the horizon, eliminates the weakest signals, then computes its location in relation to those satellites. Once the GlobalMap 5150c figures its latitude and longitude, it plots that position on the moving map shown on the screen. The whole process takes place several times a second!

The performance doesn't stop there. Stored in the permanent memory of each unit is a basic background map of the *entire* world. We lock it in here at the factory — you can't change or erase this map.

The background map is suitable for many navigation chores, but for maximum accuracy and much more detail, you need our optional map-making software, MapCreate, or one of our special plug-and-play mapping cards. Some unit features — such as searching for businesses and addresses — won't work without a custom MapCreate map. There is so much detail in our background map and even more in MapCreate that we'll describe their contents and differences in Section 3, *Basic GPS Operations*, on page 33.

Another portion of the GlobalMap 5150c onboard memory is devoted to *recording* GPS navigation information, which includes waypoints, event marker icons, trails and routes. This lets you look back the way you came. Think of this data storage like the hard drive memory in a computer or a tape in a cassette tape recorder. You can save several different GPS data files, erase 'em and record new ones, over and over again. Like any computer file, these **GPS Data Files** (file format \*.usr) can be shared between Lowrance GPS or sonar/GPS units or even personal computers.

This GlobalMap 5150c has one more thing in common with a personal computer. Just as computers have a floppy disk drive for storing and exchanging files, the unit has a slot for an MMC (MultiMedia Card) or SD card (Secure Digital card) flash memory card. These solid-state memory devices are about the size of a postage stamp, but can hold data ranging from 8 MB to 1 GB in size. (Compare that to a floppy disk's 1.44 MB capacity!) This unit uses all that MMC space for two key GPS purposes.

First, you can backup your onboard GPS Data Files by copying them to the MMC. Since the MMC is removable (like a floppy disk or a cassette tape), you can store these GPS Data Files on a personal computer equipped with an MMC card reader. Or store them on a pocketful of MMCs, if you don't have a computer. Our MapCreate mapping software can save, edit or create its own GPS Data Files, which can be copied to the MMC and then loaded from the MMC into the unit's memory. No matter where they come from, GPS Data Files *must* be loaded from the MMC into memory before the GlobalMap 5150c can use them.

The other key GPS use for MMCs is storage of special high-detail, custom maps, which you can produce on your computer with our MapCreate software. These MapCreate custom maps contain much greater detail than the basic background map. These **Custom Map Files** (file format \*.lcm) can also be shared between Lowrance GPS or sonar/GPS units and personal computers.

This unit automatically reads Custom Map Files directly from the MMC or SD card. To use a custom map, all you need to do is slide an MMC containing a map into the GlobalMap 5150c.

## Introduction to GPS and WAAS

Well, now you know the basics of how the unit does its work. You might be ready to jump ahead to Section 2, *Installation & Accessories*, on page 11, so you can mount your GlobalMap 5150c and plug in the power. Or you might want to see how our text formatting makes the manual tutorials easy to skim. If that's the case, move on to "How to Use This Manual" on page 8. But, if you want to understand the current state of satellite navigation, look over this segment describing how GPS and its new companion WAAS work together to get you where you're going.

The Global Positioning System (GPS) was launched July 17, 1995 by the United States Department of Defense. It was designed as a 24-hour-a-day, 365-days-a-year, all weather global navigation system for the armed forces of the U.S. and its allies. Civilian use was also available at first, but it was less accurate because the military scrambled the signal somewhat, using a process called Selective Availability (SA).

GPS proved so useful for civilian navigation that the federal government discontinued SA on May 2, 2000, after the military developed other methods to deny GPS service to enemy forces. Reliable accuracy for civilian users jumped from 100 meters (330 feet) under SA to the present level of 10 to 20 meters (about 30 to 60 feet.)

Twenty-four satellites orbit 10,900 nautical miles above the Earth, passing overhead twice daily. A series of ground stations with precisely surveyed locations controls the satellites and monitors their exact locations in the sky. Each satellite broadcasts a low-power signal that identifies the satellite and its position above the earth. Three of these satellites are spares, unused until needed. The rest virtually guarantee that at least four satellites are in view nearly anywhere on Earth at all times.

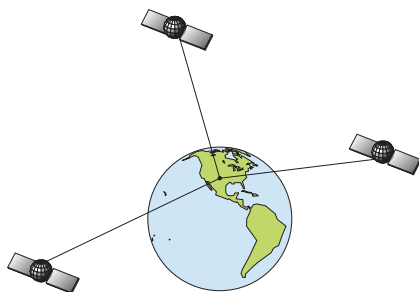

**A minimum of three satellites are required to determine a 2D fix.**

The system requires signal reception from three satellites in order to determine a position. This is called a 2D fix. It takes four satellites to

determine both position and elevation (your height above sea level — also called altitude). This is called a 3D fix.

Remember, the unit must have a clear view of the satellites in order to receive their signals. Unlike radio or television signals, GPS works at very high frequencies. These signals can be easily blocked by trees, buildings, an automobile roof, even your body.

Like most GPS receivers, this unit doesn't have a compass or any other navigation aid built inside. It relies solely on the signals from the satellites to calculate a position. Speed, direction of travel, and distance are all calculated from position information. Therefore, in order for the GlobalMap 5150c to determine direction of travel, you must be moving and the faster, the better. This is not to say that it won't work at walking or trolling speeds — it will. There will simply be more "wandering" of the data shown on the display.

GPS alone is plenty accurate for route navigation, but the U.S. Federal Aviation Administration has special aircraft navigation needs that go beyond basic GPS. Consequently, the FAA has developed a program to boost GPS performance with its Wide Area Augmentation System (WAAS). The FAA commissioned the system on July 11, 2003.

WAAS is designed to increase GPS accuracy to within 7.6 meters vertically and horizontally, but according to the FAA, it consistently comes within 1-2 meters horizontally and 2-3 meters vertically. It does this by broadcasting correction signals on GPS frequencies. Your unit automatically receives both GPS and WAAS signals.

There are, however, some fringe areas of the U.S., including parts of Alaska, that do not yet receive robust WAAS coverage. Continued WAAS development is planned to extend WAAS coverage in the years to come.

WAAS boosts the accuracy of land GPS navigation, but the system is designed for aircraft. The satellites are in a fixed orbit around the Equator, so they appear very low in the sky to someone on the ground in North America. Aircraft and vessels on open water can get consistently good WAAS reception, but terrain, foliage or even large man-made structures can sometimes block the WAAS signal from ground receivers.

You'll find that using your GPS receiver is both easy and amazingly accurate. It's easily the most accurate method of electronic navigation available to the general public today. Remember that this receiver is only a tool. Always have another method of navigation available, such as a map or chart and a compass.

Also remember that this unit will always show navigation information in the shortest line from your present position to a waypoint, regardless of terrain! It only calculates position, it can't know what's between you and your destination, for example. It's up to you to safely navigate around obstacles, no matter how you're using this product.

## How to use this manual: typographical conventions

Many instructions are listed as numbered steps. The keypad and arrow "keystrokes" appear as boldface type. So, if you're in a real hurry (or just need a reminder), you can skim the instructions and pick out what menu command to use by finding the boldface command text. The following paragraphs explain how to interpret the text formatting for those commands and other instructions:

### Arrow Keys

The arrow keys control the movement of dotted cross-hair lines on your mapping screen called the cursor. The arrow keys help you move around the menus so you can execute different commands. They are represented by symbols like these, which denote the down arrow key, the up arrow, the left arrow and the right arrow: ↓ ↑ ← →.

### Keyboard

The other keys perform a variety of functions. When the text refers to a key to press, the key is shown in bold, sans serif type. For example, the "Enter/Icons" key is shown as **ENT** and the "Menu" key is shown as **MENU**.

### Menu Commands

a menu command or a menu option will appear in small capital letters, in a bold sans serif type like this: **ROUTE PLANNING**. These indicate that you are to select this command or option from a menu or take an action of some kind with the menu item. Text that you may need to enter or file names you need to select are show in italic type, such as *trail name*.

### Instructions = Menu Sequences

Most functions you perform with this unit are described as a sequence of key strokes and selecting menu commands. We've written them in a condensed manner for quick and easy reading.

For example, instructions for navigating a trail would look like this:

1. From the Map Page, press **MENU | MENU | ↓** to **MY TRAILS | ENT**.
2. Press ↓ to *Trail 1* | **ENT** | → | ↓ to **NAVIGATE | ENT**.
3. You are asked to wait while it converts the trail into a route.

4. The wait message disappears and the GlobalMap 5150c begins showing navigation information along the trail. Now, begin moving and follow your GlobalMap 5150c.

Translated into complete English, step 1 above would mean: "Start on the Map Page. Press the Menu key twice. Next, repeatedly press (or press and hold) the down arrow key to scroll down the menu and select (highlight) the My Trails menu command. Finally, press the Enter key."

Step 2 would mean: "Press the down arrow key repeatedly to scroll to the trail named Trail 1, and press Enter. Next, press the right arrow key and then the down arrow key to highlight the Navigate command, then press Enter."

# Notes



# Section 2:

## Installation & Accessories

### Preparations

You can install the GPS system in some other order if you prefer, but we recommend this installation sequence:

#### **Caution:**

*You should read over this entire installation section before drilling any holes in your vehicle or vessel!*

1. Determine the approximate location for the GPS unit, so you can plan how and where to route the cables for the antenna and power. This will help you make sure you have enough cable length for the desired configuration.
2. Determine the approximate location for the GPS antenna module and its cable route.
4. Determine the location of your battery or other power connection, along with the power cable route.
6. Install the GPS antenna and route the antenna cable to the GPS unit.
7. Install the power cable and route it to the GPS unit.
8. Mount the GPS unit.

### GPS Antenna/Receiver Module Installation

The GlobalMap 5150c package includes the LGC-12w GPS module. This device contains the GlobalMap 5150c external antenna and receiver for GPS and WAAS signals. The antenna/receiver module comes with a 25-foot extension cable. This module can be mounted on a flat surface or pole, or a magnet is included for temporary mounting on any ferrous surface.



LGC-12w Module, bottom view (left) and top view (right).

You need to select an antenna installation location that has a clear, unobstructed view of the sky. After the module is installed, route the cable to the unit, plug it in the center socket on the back and your system is ready to use. See the module's instruction sheet, publication part number 988-0148-371, for complete installation directions.

In an automobile, you may achieve good results by simply placing the external antenna on the top of the dash, at the base of the windshield. a piece of the rubber non-skid shelf liner material available in recreational vehicle supply stores will help hold the antenna in place. This may not work well if you have a cab-over design pickup truck camper or motor home. If dashboard reception is poor, simply relocate the antenna module elsewhere on the vehicle for a clearer view of the sky.

## **Power Connections**

The GlobalMap 5150c works from a 12-volt battery system. For the best results, attach the power cable directly to the battery. You can attach the power cable to an accessory or power buss, but you might have problems with electrical interference. Therefore, it's safer to go ahead and attach the power cable directly to the battery.

### **CAUTION:**

*When using the unit in a saltwater environment, we strongly recommend that you shut off the power supply to the power cable when the unit is not in use. When the unit is turned off but still connected to a power supply, electrolysis can occur in the power cable plug. This may result in corrosion of the plug body along with the electrical contacts in the cable and the unit's power socket.*

*In saltwater environments we recommend you connect the power cable to the auxiliary power switch included in most boat designs. If that results in electrical interference, or if such a switch is not available, we recommend connecting direct to the battery and installing an inline switch. This will let you shut off power to the power cable when the unit is not in use. When you are not using the unit, you should always shut off power to the power cable, especially when the power cable is disconnected from the unit.*

If possible, keep the power cable away from other boat wiring, especially the engine's wires. This will provide the best isolation from electrical noise. If the cable is not long enough, splice #18 gauge wire onto it. The power cable has two wires, red and black. Red is the positive lead, black is negative or ground. Make sure to attach the in-line fuse holder to the red lead *as close to the power source as possible*.

For example, if you have to extend the power cable to the battery or power buss, attach one end of the fuse holder directly to the battery or power buss. This will protect both the unit and the power cable in the event of a short. It uses a 3-amp fuse.

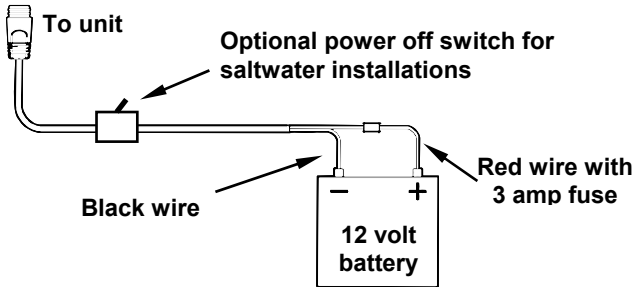

Power connections for the GlobalMap 5150c GPS unit.

**WARNING:**

This product *must* be independently fused with the enclosed 3-amp fuse (or equivalent), even if you connect to a fused accessory or power buss.

*If a malfunction happens inside the unit, extensive damage can occur if the enclosed fuse is not used. As with all electrical devices, this unit could be damaged to a point that it is not repairable and could even cause harm to the user when not properly fused.*

**CAUTION:**

*Failure to use the enclosed 3-amp fuse will void your warranty! For a replacement, use a type 3AG 3-amp fuse.*

This unit has reverse polarity protection. No damage will occur if the power wires are reversed. However, the unit will not work until the wires are attached correctly.

An optional 8-foot, CA-4 external power cable with a cigarette lighter adapter is available from Lowrance.

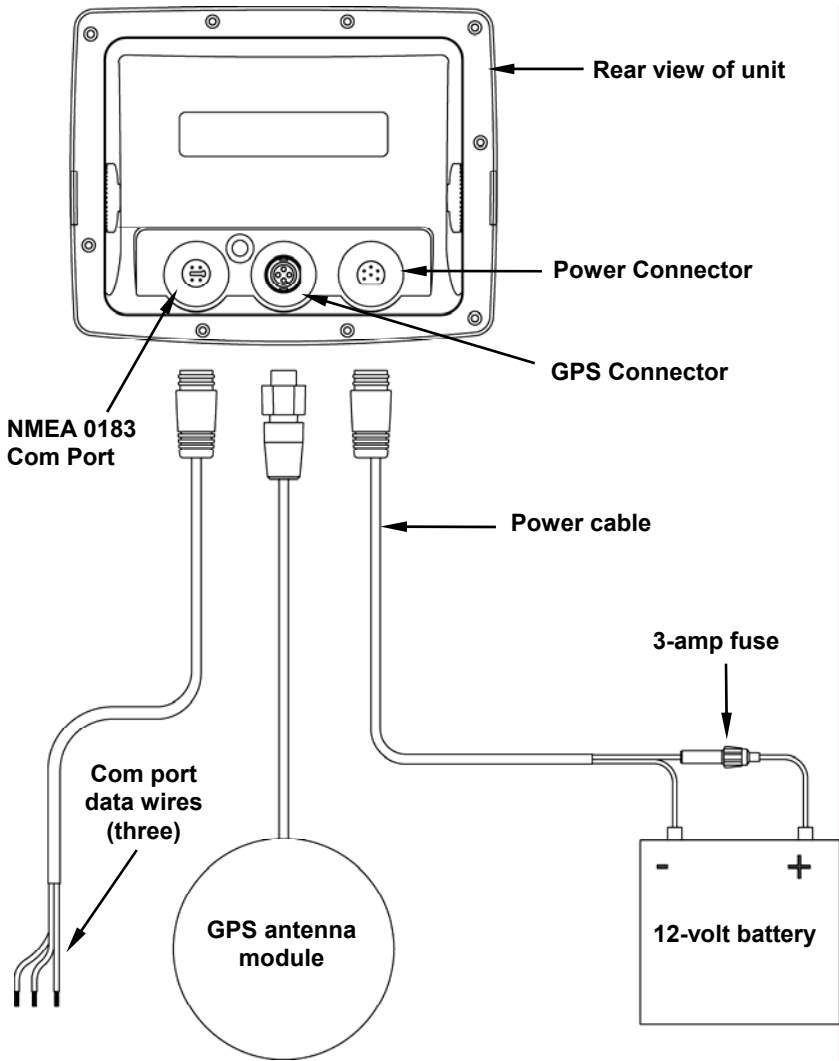

**Cable connections.**

## **NMEA Cable Connections**

NMEA is a standard communications format for marine electronic equipment. For example, an autopilot can connect to the NMEA interface on the GlobalMap 5150c and receive positioning information. The GlobalMap 5150c can exchange information with any device that transmits or receives NMEA 0183 data.

See the diagrams on the following page for general wiring connections. Read your other product's owner's manual for more wiring information.

### NMEA Wiring

To exchange NMEA data, the GlobalMap 5150c has one NMEA 0183 version 2.0 communication port. Com port one (Com-1) can be used to receive NMEA format GPS data. The com port can also transmit NMEA format GPS data to another device.

The data cable contains three wires. Com-1 uses the yellow wire to transmit, the orange wire to receive and the shield wire for signal ground.

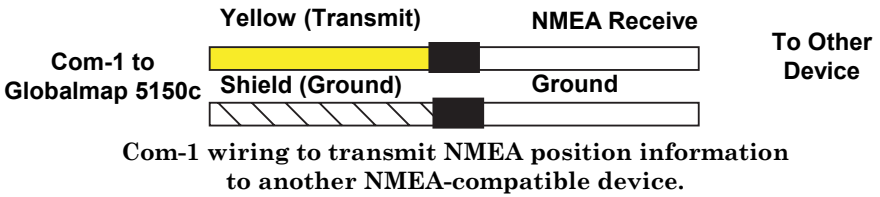
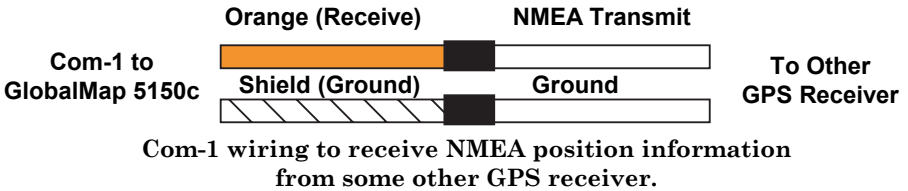

### Mounting the Unit: Bracket, In-Dash or Portable

You can install the GlobalMap 5150c on the top of a dash with the supplied gimbal bracket. It can also be installed in the dash or mounted on a portable power supply.

If you use the supplied bracket, you may be interested in an optional R-A-M<sup>®</sup> bracket mounting system. This converts the unit's gimbal bracket to a swivel mount, which can be used on the dash or overhead mounting positions. R-A-M offers permanent mounts and temporary mounts suitable for many vehicle types. See your Lowrance dealer or visit the LEI web site ([www.lei-extras.com](http://www.lei-extras.com)) for the latest options; accessory ordering information is on the inside back cover of this manual. For a complete look at the many mounting options, visit the RAM web site at [www.ram-mount.com](http://www.ram-mount.com).



**Optional R-A-M mounting system.**

### **Bracket Installation**

Mount the GlobalMap 5150c in any convenient location, provided there is clearance behind the unit when it's tilted for the best viewing angle. You should also make sure there is enough room behind the GlobalMap 5150c to attach the power and GPS antenna/receiver module cables. A drawing on the next page shows the dimensions of a gimbal-mounted GlobalMap 5150c.

Holes in the bracket's base allow wood screw or through-bolt mounting. You may need to place a piece of plywood on the back side of thin fiberglass panels to reinforce the panel and secure the mounting hardware.

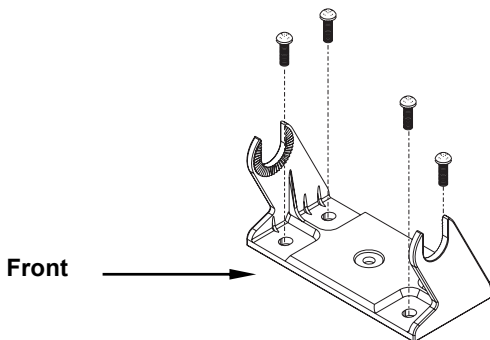

**Install the gimbal bracket. Orient the bracket so the arms slope toward the front of your unit.**

Drill a 1-inch (25.4 mm) hole in the dash for the power and antenna cables. The best location for this hole is immediately under the gimbal bracket location.

This way, the bracket can be installed so that it covers the hole, holds the cables in position and results in a neat installation. Some customers, however, prefer to mount the bracket to the side of the cable hole — it's a matter of personal preference.

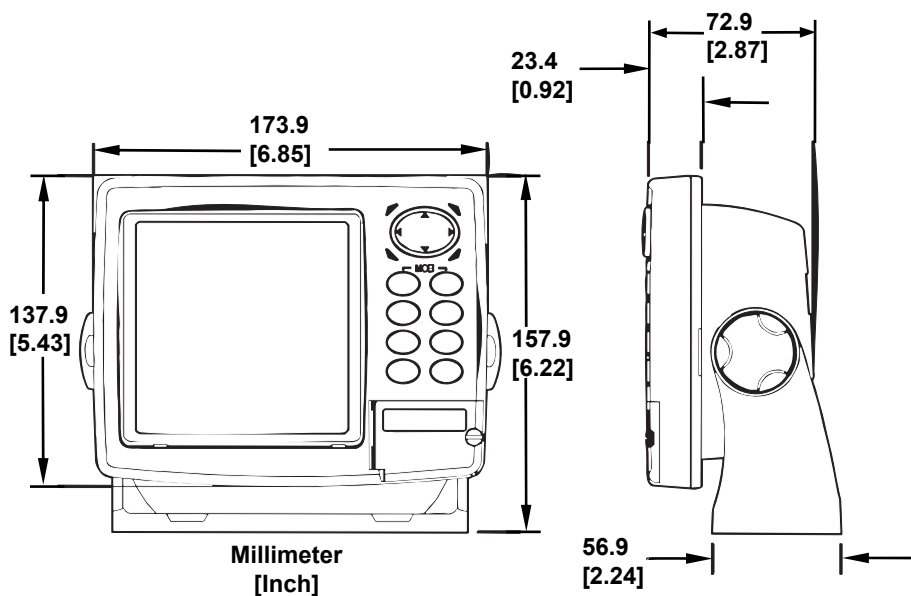

Front view (left) and side view (right) showing dimensions of the GlobalMap 5150c when mounted on gimbal bracket.

After drilling the hole, pass the antenna connector *up* through the hole from under the dash. Pass the power cable's bare-wire end *down* through the hole from the top.

If you wish, you can fill in the hole around the cables with a good marine caulking compound. Some marine dealers stock cable hole covers to conceal the opening. No matter what type of installation you prefer, be sure to leave enough slack in the cables to allow tilting or swiveling the GlobalMap 5150c. If you choose to fill in the hole, be sure to position the cables against the rear edge of the hole as you apply the fill material.

Before positioning the bracket, be sure to hold the cables against the rear edge of the hole. Then, slide the bracket over the hole and butt the rear of the bracket base firmly against the cables, thus pinning them in place against the side of the hole. Finally, fasten the bracket to the dash. Attach the unit to the gimbal bracket using the supplied gimbal knobs and washers.

### In-Dash Installation

You can mount the Globalmap 5150c in the dash with an optional FM-5 In-Dash Adapter Kit. The kit includes mounting hardware, a template for cutting the hole and an instruction sheet, part 988-0147-43.

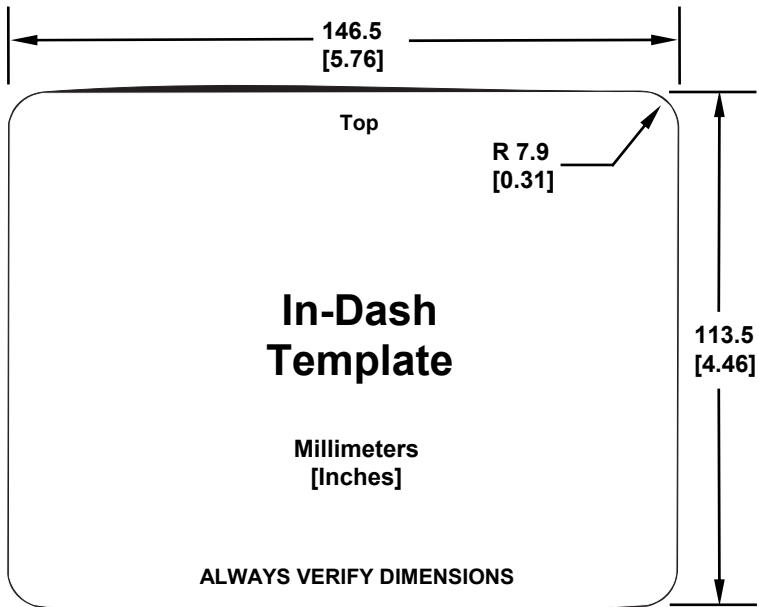

**In-dash mounting template for the GlobalMap 5150c, showing dimensions. NOTE: The figure above is *not* printed to scale. a scaled template (FM-5 In-Dash Adapter Kit instructions) is available for free download from our web site, [www.lowrance.com](http://www.lowrance.com).**

**Portable Installation**

Like many Lowrance products, the GlobalMap 5150c is capable of portable operation by using an optional portable power pack (PPP). The power pack expands the uses for your GPS unit. The PPP makes it easy to transfer your unit from a boat to a car, recreational vehicle, airplane or other vehicle without drilling and mounting a second bracket. You can use your unit in your own car or boat, then take it along when riding in a friend's vehicle that's not equipped with GPS.

Most LEI portable power packs can be used with eight "D" cell alkaline batteries. Some use an optional sealed, rechargeable battery. For information on the PPP for your unit, see the accessory ordering information inside the back cover of this manual.



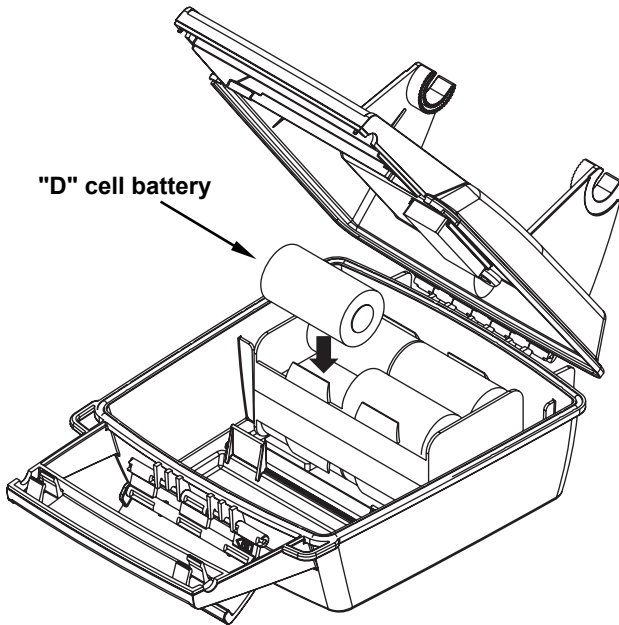

**Installing batteries in a typical portal power pack.**

## **MMC or SD Card Memory Card Installation**

Your GlobalMap 5150c uses a MultiMedia Card to store information, such as custom maps, waypoints, trails and other GPS data. The unit can also use Secure Digital Cards (SD card or SDC) to store data.

### **NOTE:**

Throughout this manual, we will use the term MMC, but just remember that your unit can use an MMC *or* SD card to store data.

Both of these solid-state flash memory devices are about the size of a postage stamp. An SD card is slightly thicker than an MMC. As this manual went to press, MMCs and SD cards were available in various storage capacities up to 1 gigabyte.

Additional MMC cards are available from LEI Extras; see ordering information inside the back cover of this manual. MMCs and SD cards are also available at many camera and consumer electronics stores.

The MMC slot is located in a compartment on the front of the case. The compartment door is located at the lower right corner. The following figure shows a close-up with the door opened.



Memory card compartment with a 16 MB MMC card installed.

### To remove an MMC

1. Open the card compartment door by unscrewing the thumb screw. The screw should only be finger tight. If it was over-tightened, use a thumbnail, a coin or a screwdriver to open the door.
2. Just press a finger against the label of the MMC and drag it from the slot.
3. Close the compartment door and fasten the thumb screw finger tight.

### To add an MMC or SD Card

1. Open the card compartment door.
2. Grasp the bottom of the MMC and push the top of the card into the slot. Once the card is started, use your fingernails to slide it the rest of the way to the left, until it is firmly seated in the slot.
3. Close the compartment door and fasten the thumb screw finger tight.

## Other Accessories

### Cleaning Towel

A lint-free microfiber towel is included for cleaning the unit's screen. The towel is highly effective in clearing away water spots, smudges and finger prints. Just wipe the screen with the dry towel — it's not necessary to moisten the towel with water. If the screen is badly soiled, you may use water or common window or lens cleaners. However, **DO NOT** use polishing compounds or any other abrasive product.

If you lose the towel or wear it out, you can replace it with a similar microfiber cloth. These are often available where shop towels or automobile cleaning towels are sold.

### Caution:

*Cleaning fabrics other than the microfiber towel type may scratch the screen. Polishing compounds or other abrasive cleaners will scratch the screen. Damage caused by incorrect cleaning is not cov-*

*ered by the warranty. You may wash the towel if it becomes soiled or loses its effectiveness, but do not use fabric softener. Fabric softener will ruin the towel's cleaning capability.*

Other accessories include MMC cards, MMC card readers and MapCreate custom mapping software for your computer. MMC card readers are available in USB and parallel port versions.

If these accessories are not available from your dealer, see the accessory ordering information on the inside back cover of this manual.

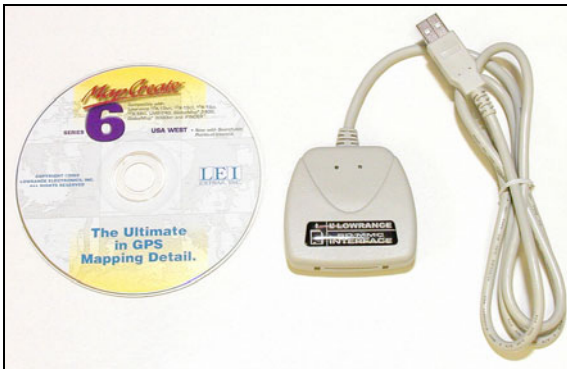

**MapCreate CD-ROM (left) and MMC card reader for USB ports on the right.**

Now that you have your GlobalMap 5150c installed, move on to Section 3, *Basic GPS Operations*. There, we'll present a series of step-by-step tutorials to teach you the basics of GPS navigation.

## **Face Cover**

A white protective cover that snaps on and off the front of the unit is available. This cover is intended for use when the vehicle is idle.

### **WARNING:**

**When the unit is mounted in an unprotected area, such as an open boat cockpit, the protective face cover must be removed when the vehicle is moving at high speed. This includes towing a boat on a trailer at highway speeds. Otherwise, wind blast can pop off the cover.**

# Notes

## Section 3: Basic GPS Operations

This section addresses the unit's *most basic* GPS operations. The tutorials presented in Sec. 3 follow a chronological order. Sec. 4, *Advanced GPS Operations*, will discuss other more advanced functions and utilities. Material in Sec. 4 is arranged in alphabetical order.

Before you turn on the unit and find where you are, it's a good idea to learn about the different keys, the three Page screens and how they all work together. BUT, if you just can't wait to get outside, turn to the one-page *Quick Reference* on page 39.

### Keyboard



GlobalMap 5150c GPS unit, front view, showing Map Page, keyboard and access door for the MMC slot.

1. **PWR/LIGHT** (Power & Light) – The PWR key turns the unit on and off and activates the backlight.
2. **PAGES** – Pressing this and the ← → arrow keys (4) switches the unit between the three different page screens. (Satellite Status Page, Navigation Page and Map Page.) Each page represents one of the unit's major operation modes.

3. **MENU** – Press this key to show the menus and submenus, which allow you to select a command or adjust a feature. This also accesses search functions for streets, intersections, addresses and highway exits.

4. **ARROW KEYS** – These keys are used to navigate through the menus, make menu selections and move the map cursor.

5. **ENT/ICONS** (Enter & Icons) – This key allows you to save data, accept values or execute menu commands. It is also used to create event marker icons.

6. **EXIT** – The Exit key lets you return to the previous screen, clear data or erase a menu.

7. **WPT** – (Waypoint) The Waypoint key is used to save and recall waypoints, search for waypoints and access the waypoint list. It also launches the Point-of-Interest (POI) search menus and is involved in some navigation functions.

8. **ZOUT** – (Zoom Out) – This key lets you zoom the screen out. This lets you see a larger geographic area on the map. Less detail is seen as you zoom out.

9. **ZIN** – (Zoom In) – This key lets you zoom the screen in. Zooming in lets you see greater detail in a smaller geographic area on the map.

## Power/lights on and off

To turn on the unit, press **PWR**. As the unit powers up, the Map Page is displayed first. (To switch to another page, press **PAGES** | ← or → to *Page Name* | **EXIT**.)

To turn on the backlight, press **PWR** again. The unit has three backlight levels to select from. Repeatedly pressing **PWR** will cycle through the backlight settings and turn off the backlight.

Turn off the unit by pressing and holding the **PWR** key for 3 seconds.

## Main Menu

The unit has a Main Menu, which contains some function commands and some setup option commands. The tutorial lessons in this section will deal only with functions, the basic commands that make the unit do something. The GPS will work fine for these lessons right out of the box with the factory default settings. But, if you want to learn about the various options, see Sec. 5, *System Setup and GPS Setup Options*.

You can access the Main Menu from any of the three Page screens by pressing **MENU** | **MENU**. To clear the menu screen and return to the page display, press **EXIT**.

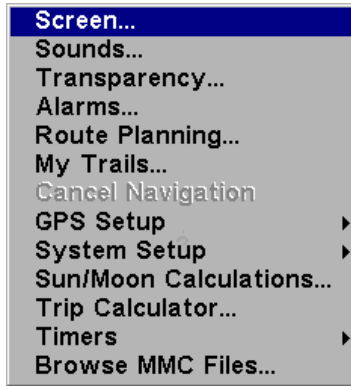

### Main Menu.

The Main Menu commands and their functions are:

**Screen** command: changes the contrast or brightness of the display screen.

**Sounds** command: enables or disables the sounds for key strokes and alarms and sets the alarm style.

**Transparency** command: adjust the level of transparency for menus.

**Alarms** command: turns GPS alarms on or off and changes alarm thresholds.

**Route Planning** command: used to plan, view or navigate a route.

**My Trails** command: shows, hides, creates and deletes plot trails. Also used to navigate or backtrack a trail.

**Cancel Navigation** command: turns off the various navigation commands. Used to stop navigating after you have reached your destination waypoint, Point of Interest or map cursor location; or after you reach the end of a route or trail.

**GPS Setup** command: sets various GPS receiver options.

**System Setup** command: sets general configuration options.

**Sun/Moon Calculations** command: finds the rising and setting time of the sun and the moon.

**Trip Calculator** command: shows trip status and statistics.

**Timers** command: controls the up timer, down timer and alarm clock settings.

**Browse MMC Files** command: this allows you to view the installed MMC card and the files it contains.

## Pages

The unit has three Page displays that represent the three major operating modes. They are the Satellite Status Page, the Navigation Page and Map Page. They are accessed by pressing the **PAGES** key, then using → or ← to select a Page. (Clear the Pages Menu by pressing **EXIT**.)

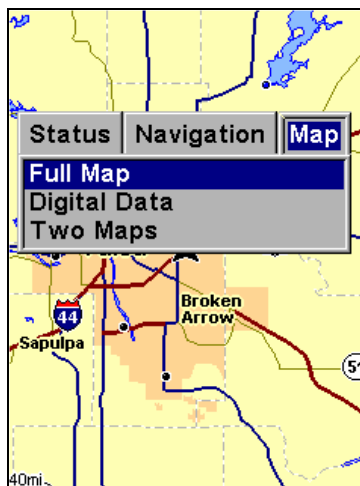

Pages Menu, showing some Map display options.

### Satellite Status Page

The Satellite Status Page, shown in the following images, provides detailed information on the status of the unit's satellite lock-on and position acquisition. To get to the Satellite Status Page: Press the **PAGES** key, then use → or ← to select **STATUS**. (Clear the Pages Menu by pressing **EXIT**.)

No matter what Page you are on, a flashing current position indicator/question mark symbol and flashing GPS data displays indicate that satellite lock has been lost and there is no position confirmed. The Satellite Status Page shows you the quality and accuracy of the current satellite lock-on and position calculation.

### WARNING:

**Do not begin navigating with this unit until the numbers have stopped flashing!**



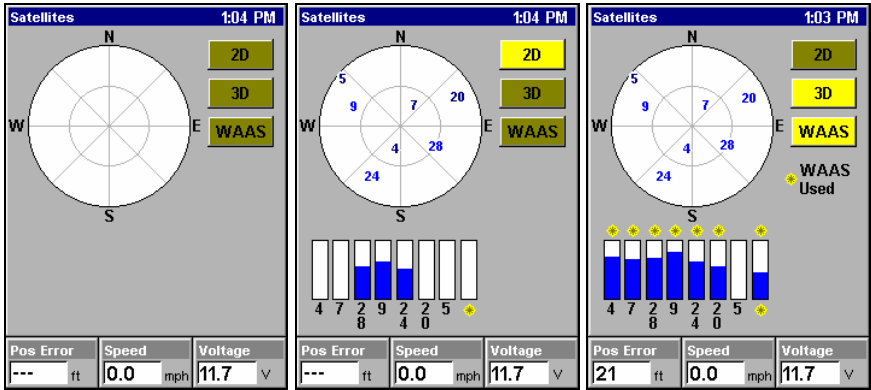

**Satellite Status Page.** The first image (left) indicates unit has not locked on to any satellites and has no fix on its position. The second image (center) shows satellites being scanned. The third image (right) shows satellite lock-on with 3D position acquired (latitude, longitude and altitude), and WAAS reception.

This screen shows a graphical view of the satellites that are in view. Each satellite is shown on the circular chart relative to your position. The point in the center of the chart is directly overhead. The small inner ring represents 45° above the horizon and the large ring represents the horizon. North is at the top of the screen. You can use this to see which satellites are obstructed by obstacles in your immediate area if the unit is facing north.

The GPS receiver is tracking satellites that are in bold type. The receiver hasn't locked onto a satellite if the number is grayed out, therefore it isn't being used to solve the position.

Beneath the circular graph are the bar graphs, one for each satellite in view. Since the unit has twelve channels, it can dedicate one channel per visible satellite. The taller the bar on the graph, the better the unit is receiving the signals from the satellite.

You can set up custom digital gauges through the Satellite Status page menu. The Custom Gauges feature allows you to monitor a wide variety of data from one page.

**To set up Custom Gauge page:**

1. Select the **SATELLITE STATUS** page from the Pages menu, highlight **CUSTOM GAUGES** and press **ENT**.
2. Press **MENU**. **OVERLAY DATA** will highlighted. Ppress **ENT**. The Overlay Data shown menu will appear.

3. Highlight (**PRESS ENT TO ADD...**) and press **ENT** to open the Data Viewer menu with five expandable data categories: GPS Data, Navigation, Trip Calculator, Time and Sensor Data.

4. Highlight the desired data category and press **ENT**, which will expand the list, revealing several subcategories with checkboxes next to them.

5. Select the desired subcategory and press **ENT**, which will place a checkmark in the checkbox, showing the selected data is set for display.

6. If you want to display other data types, repeat Steps 4 and 5. Press **EXIT** repeatedly to get back to the Custom Gauges page. The data you selected will now be displayed on the screen.

#### **To change Overlay data size:**

1. From the Custom Gauges page, press **MENU SELECT OVERLAY DATA** and press **ENT**. The Overlay Data Shown menu will appear.

2. Highlight the *Data Type* you want to resize, then use ← → to set the data to the desired size to one of four options: Off, Small, Medium, Large and Enormous.

3. To change the size of another Data Type, repeat the steps above. To return to the Custom Gauges display, press **EXIT**.

#### **NOTE:**

One of the data display options for the Satellite Status page is "Position Error" (horizontal position error), which can appear in one of the page's data boxes. Position Error will show you the expected error from a benchmark location. In other words, if the Position Error box shows 50 feet, then the position shown by the unit is estimated to be within 50 feet of the actual location.

This also gives you an indicator of the fix quality the unit currently has. The smaller the position error number, the better (and more accurate) the fix is. If the position error flashes dashes, then the unit hasn't locked onto the satellites, and the number shown isn't valid. (For details, see *Customize Page Displays*, on page 78.)

The Satellite Status Page has its own menu, which is used for setting various options. (Options and setup are discussed in Sec. 5). To access the Satellite Status Page Menu, from the Status Page, press **MENU**.

#### **Navigation Page**

This screen has a compass rose that not only shows your direction of travel, but also the direction to a recalled waypoint. To get to the Navigation Page: Press **PAGES** | → or ← to **NAVIGATION** | **EXIT**.

The navigation screen looks like the one below when you're *not* navigating to a waypoint or following a route or trail. Your position is

shown by an arrow in the center of the screen. Your trail history, or path you've just taken, is depicted by the line extending from the arrow. The arrow pointing down at the top of the compass rose indicates the current track (direction of travel) you are taking.

**Track or compass heading indicator, showing direction of travel**

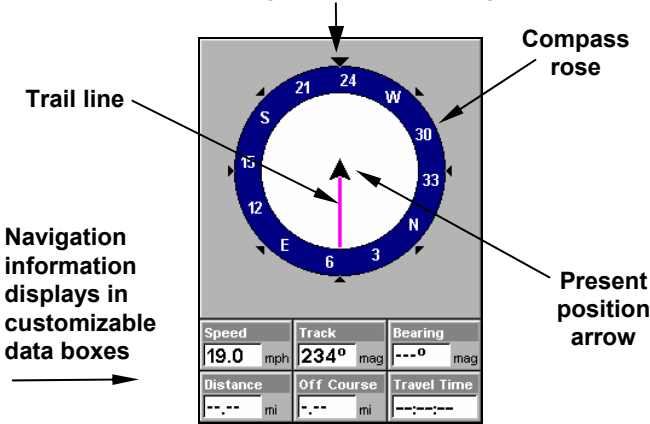

**Navigation Page, recording a trail, traveling southwest. Page looks like this when the unit is not navigating to a waypoint, following a route, or backtracking a trail.**

When navigating to a waypoint, the Navigation screen looks like the following figure. Your ground speed, track, distance and bearing to waypoint, and course are all shown digitally on this screen.

**NOTE:**

Remember, when the Speed, Track and Position information displays are flashing, satellite lock has not been achieved and no position fix has been determined. A question mark will also flash on the present position arrow in the center of the compass rose.

Speed (ground speed) is the velocity you are making over the ground. (If you wish, you can customize the Speed data box to display Closing Speed instead. Closing Speed is also known as velocity made good. It's the speed that you're making toward the waypoint. For instructions, see the Customize Page Displays entry in Sec. 5.)

Track is the heading, or the current direction you are actually traveling. Bearing is the direction of a line-of-sight from your present position to the destination. No matter what direction you are steering, the Bearing window shows the compass direction straight to the destination from your location at the moment. Distance shows how far it is to the waypoint you're navigating toward.

The Off Course window shows the current cross track error. This shows the distance you are off-course to the side of the desired course line. The course line is an imaginary line drawn from your position when you started navigating to the destination waypoint. The course line is shown on the Navigation Page screen (and the Map Page screen) as a dotted line.

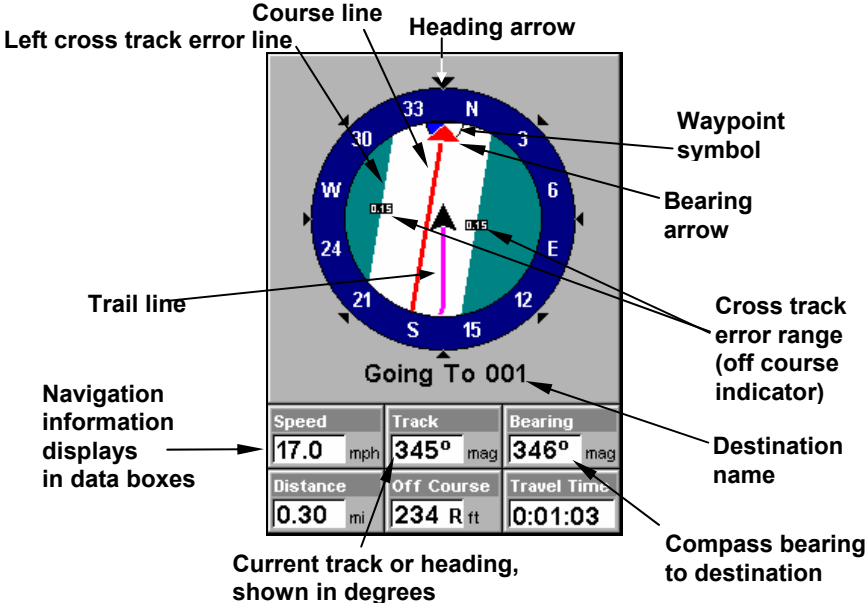

**Navigation Page, going to a waypoint while creating a new trail.**

The cross track error range is shown on the compass rose as a wide, white, corridor enclosing the course line. The outer edges of this white corridor represent lines that show the current cross track error range. The default for the cross track error range is 0.20 miles.

For example, if the present position symbol touches the right cross track error line, then you are 0.20 miles to the right of the desired course. You need to steer left to return to the desired course. You can use the **ZIN** or **ZOUT** keys to change the cross track error range.

A circular symbol depicting your destination (waypoint) appears on the screen as you approach the waypoint, as shown on the screen in the preceding figure.

Travel Time is the time that it will take to reach your destination at your present closing speed. (You can also customize the time data box to show Arrival Time instead. Arrival Time is the local time it will be when you arrive at the destination, based upon your present closing speed and track.)

In the preceding example figure, the driver is headed northwest (a 345° track) toward a waypoint 346° (bearing) away. The cross track error range (white corridor) is 0.15 miles either side of the course. The driver is headed toward trail waypoint 1, which is 0.3 miles away. The vehicle is 234 feet right of the original course. Traveling at a speed of 17 mph, the driver will arrive at the waypoint in 1 minute, 3 seconds.

The Navigation Page has its own menu, which is used for some advanced functions and for setting various options. (Options and setup are discussed in Sec. 5). To access the Navigation Page Menu, from the Navigation Page, press **MENU**.

### **Map Page**

The Map Page screens show your course and track from a "bird's-eye" view. By default, this unit shows the map with north always at the top of the screen. (This can be changed. See the topic *Map Orientation*, in Sec. 5.) If you're navigating to a waypoint, the map also shows your starting location, present position, course line and destination. You don't have to navigate to a waypoint, however, to use the map.

Map Page is the default screen that appears when you turn on the unit. To get to the Map Page from another page: Press **PAGES** | → or ← to **MAP** | **EXIT**. When the Map Page is displayed, a screen similar to the following figures appears.

The arrow in the center of the screen is your present position. It points in the direction you're traveling. The solid line extending from the back of the arrow is your plot trail, or path you've taken.

The map zoom range is the distance across the screen. This number shows in the lower left corner of the screen. In the first of the following example figures, the range is 4,000 miles from the left edge of the map to the right edge of the map.

The Zoom In and Zoom Out keys zoom the map to enlarge or reduce its coverage area and the amount of mapping detail shown. There are 40 available map zoom ranges, from 0.02 miles to 4,000 miles.

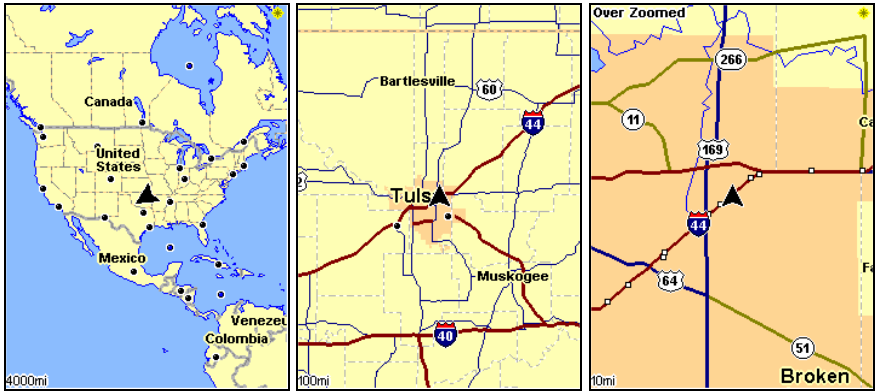

Map Page opening screen (left). Map oomed to 100 miles (center). Map zoomed to 10 miles (right). Over Zoomed means you have reached the detail limits in an area covered only by the basic background map. Zooming in any closer will reveal no more map details because a high-detail custom map has not been loaded on the MMC for this area.

If you're using only the factory-loaded background map, the maximum zoom range for showing *additional* map detail is 15 miles. You can continue to zoom in closer, but the map will simply be enlarged without revealing more map content (except for a few major city streets.) Load your own high-detail custom map made with MapCreate (or a pre-made FreedomMap from LEI), and you can zoom in to 0.02 miles with massive amounts of accurate map detail.

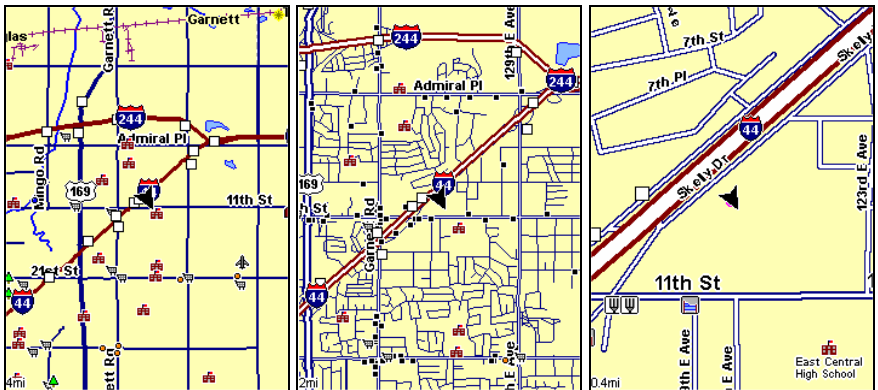

Map Pages with high-detail MapCreate map of urban area loaded on the MMC. Arterial streets are visible at the 4 mile zoom range (left). Numerous dots representing Points of Interest are visible at the 2 mile range, along with minor streets (center). At a 0.4-mile zoom (right), you can see an interstate highway with an exit, major and minor streets as well as Point of Interest icons.

## **Background map vs. MapCreate map content**

The special built-in Lowrance background map contains basic world-wide coverage of major inland lakes, rivers, streams and coastal waters, plus key cities, highways, and more.

MapCreate custom maps include massive amounts of information not found in the background map. MapCreate maps contain the searchable Points of Interest database, all the minor roads and streets, all the landmark features (such as summits, schools, radio towers, etc.); more rivers, streams, smaller lakes and ponds and their names.

What is more important is the large scale map detail that allows your GPS unit to show a higher level of position accuracy. For example, the background map would show you the general outline and approximate shape of a coastline or water body, but the higher detail in MapCreate shows the shoreline completely and accurately (finer detail). Many smaller islands would not be included in the background map, but are included in MapCreate.

### **NOTE:**

Available through LEI Extras – look inside back cover for accessory ordering information – FreedomMaps(TM) are pre-made maps that contain all of the same information available in a custom MapCreate map, without any of the work of preparation. FreedomMaps are available for Europe and North America. Each chart is preloaded on a plug and play digital memory card that you just install in your GPS unit.

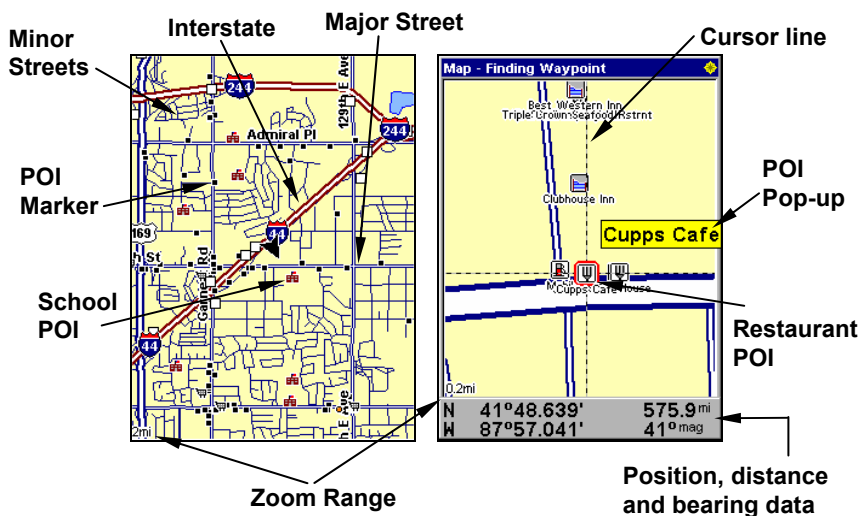

When the map is zoomed out far enough, most POIs appear as square dots (left). As you zoom in closer, the symbols become readable icons. In the 0.2 mile zoom example (right), the cursor has selected the Cupps Café POI, which triggers a pop-up box with the POI name. This pop-up box works on POIs at any zoom range.

**Tip:**

In some urban areas, businesses are so close to one another that their POI icons crowd each other on the screen. You can reduce screen clutter and make streets and other map features easier to see by simply turning off the *display* of POIs you're not watching for. (To see how, check the text on Map Detail Category Selection, page 83. It shows how to use the Map Categories Drawn menu to turn individual POI displays off and on.) Even though their display is turned off, you can still search for POIs and their icons will pop-up when your unit finds them for you.

The Map Page has its own menu, which is used for several functions and for setting various options. To access the Map Page Menu, from the Map Page, press **MENU**.

The Pages Menu also offers several map display options under the Map Page category. To access them, press **PAGES** | ← or → to **MAP** | ↓ to *Option* | **EXIT**.



Speed	0.0 mph
Distance	--. mi
Bearing	---° mag
Track	358° mag
Off Course	--. mi 10mi
Travel Time	Degrees/Minutes
	Latitude
	N 36°27.658'
Pos Error	Longitude
	W 92°38.580'

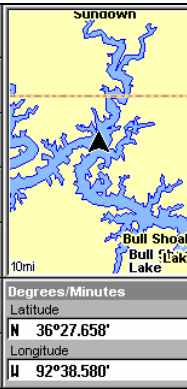

### Digital Data map page option.

In pages that have two major windows (such as two maps) you can toggle back and forth between the two windows by pressing **PAGES|PAGES**. This allows you to change which map your cursor moves on, and which map the menu operates on.

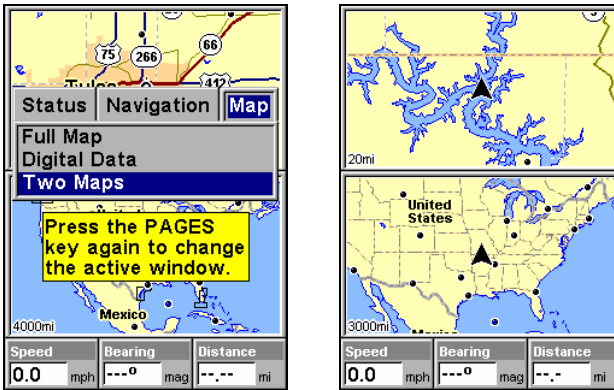

Pages Menu with Two Map option selected (left).  
Map Page with two map windows (right).

### Map with Custom Gauges

The Map with Custom Gauges page has a split screen with a map on the right side and digital gauge information on the left side. The two windows can be resized to make one side bigger than the other or may be set up to split the screen evenly.

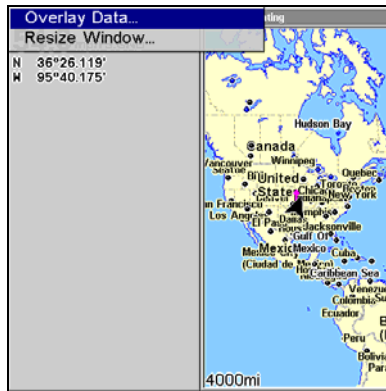

Overlay Data selected on Map with Custom Gauges menu.

**To customize digital gauge display:**

1. Press **PAGES**, highlight Map, select **MAP WITH CUSTOM GAUGES** and press **ENT**.
2. Press **MENU**, select **OVERLAY DATA** and press **ENT**. The Overlay Data shown menu will appear.
3. Highlight (**PRESS ENT TO ADD...**) and press **ENT** to open the Data Viewer menu with five expandable data categories: GPS Data, Navigation, Trip Calculator, Time and Sensor Data.
4. Highlight the desired data category and press **ENT**, which will expand the list, revealing several subcategories with checkboxes next to them.
5. Select the desired subcategory and press **ENT**, which will place a checkmark in the checkbox, showing the selected data is set for display.
6. If you want to display other data types, repeat Steps 4 and 5. Press **EXIT** repeatedly to get back to the Map with Custom Gauges page. The data you selected will now be displayed in the gray area on the left side of the screen.

**To change Overlay data size:**

1. From the Map with Custom Gauges page, press **MENU** select **OVERLAY DATA** and press **ENT**. The Overlay Data Shown menu will appear.
2. Highlight the *Data Type* you want to resize, then use ← → to switch the data setting to one of the following four options: Off, Small, Medium, Large and Enormous.
3. To change the size of another Data Type, repeat the steps above. To return to the Custom Gauges display, press **EXIT**.

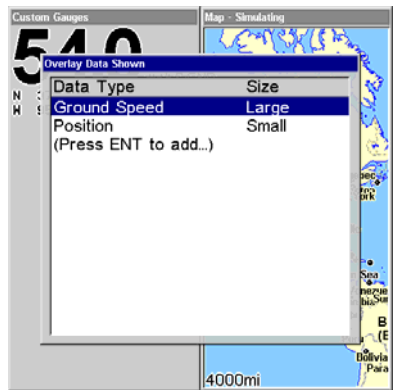
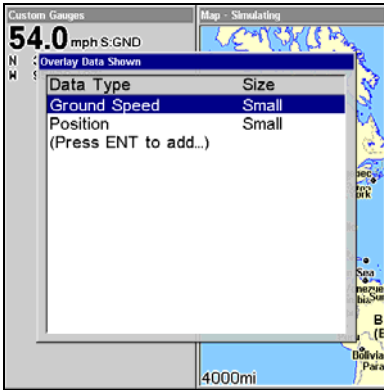

Ground Speed is set to small size (left). The size Ground Speed data has been changed to Large (right).

### Resize Window command

Resize Window is another extremely handy feature for pages that have two major windows. You can change the relative size of the windows, as well as horizontal or vertical layout, to suit your viewing preference. Here's how:

1. From any two-window display, press **MENU** | ↓ to **RESIZE WINDOW** | **ENT**.
2. Four flashing arrows appear along the centerline dividing the two windows. Press an arrow key perpendicular to the centerline to adjust the window widths. Press an arrow key parallel to the centerline to switch between horizontal and vertical layout.

Press **EXIT** to clear the four flashing arrows.

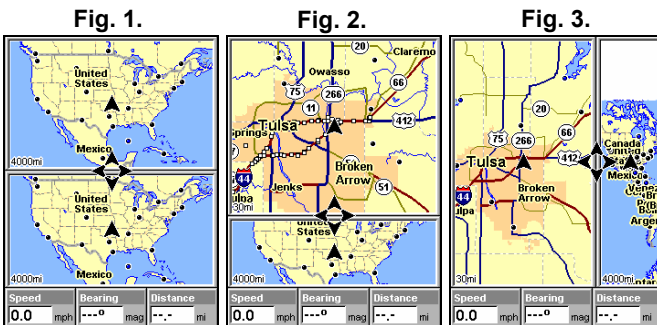

Fig. 1. Two Maps page display with four flashing arrows on the dividing centerline. Fig. 2. The centerline has been moved down to enlarge the top map, which is now zoomed in to 40 miles. Fig. 3. Pressing → has switched the page layout from horizontal to vertical – note that the relative sizes remain the same.

3. To change the window size again or revert back to the original display, just follow the steps above. (Most dual-window displays use half the screen for each window by default.) You can also use the Reset Options command to revert to the factory default.

**NOTE:**

The units described by this manual are all capable of using this command. If your unit does not have a Resize Window command on the Map Page menu, you can update your software by visiting our web site [www.lowrance.com](http://www.lowrance.com) or by contacting customer service.

### Choose Viewable Pages

The Choose Viewable Pages command allows you to turn on or turn off page displays. When a page display is turned off, it will be removed from the page display rotation that you scroll through when using the **PAGES** key.

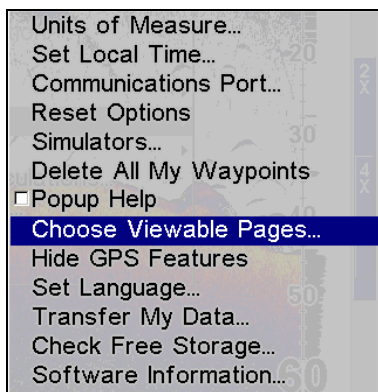

#### Choose Viewable Pages selected from System Setup menu.

1. To turn a page display on or off, press **MENU | MENU**, then use **↑ ↓** to select **SYSTEM SETUP** and press **ENT**.
2. Use **↑ ↓** to highlight **CHOOSE VIEWABLE PAGES** and press **ENT**. A list of your unit's pages will appear.
3. Highlight the desired page display and press **ENT**, to turn it on (check) or turn it off (uncheck).
4. Press **EXIT** to return to the main page display.

## Basic GPS Quick Reference

*Start outdoors, with a clear view of the open sky. As you practice, try navigating to a location at least a few blocks away. While you're learning, navigation in too small an area will constantly trigger arrival alarms.*

1. To turn on the unit, press and release **PWR** key.
2. Opening screen displays map of North America at 4,000 mile zoom range. Rotate through the three main Page screens (Map Page, Satellite Status Page and Navigation Page) by pressing **PAGES** | ← or → to select *Page Name* | **EXIT**. Switch Pages to display Satellite Status Page.
3. Wait while unit locates satellites and calculates current position. Process is visible on Satellite Page. This takes about a minutes or less under clear sky conditions (unobstructed by terrain or structures.) When position is acquired, unit sounds a tone and displays a "position acquired" message. The present position arrow and information shown in data boxes or as overlay data will stop flashing.
4. With position acquired, press **PAGES** key to display Map Page, which shows a bird's eye view of the earth. You can move around the map by:
  - Zoom in** closer to see greater detail: press **ZIN** (zoom in key.)
  - Zoom out** to see more area, less detail: press **ZOUT** (zoom out key.)
  - Scroll** map north, south, east or west using arrow keys ↑ ↓ → ← .To stop scrolling and return to current position on map, press **EXIT** key.
5. Set a waypoint (*Wpt 001*) at your current position so you can navigate back here: press **WPT** | **WPT**. Waypoint symbol and "001" appears.
6. Zoom/scroll map to find a nearby object or location to go to. Use arrow keys to center cursor cross-hair over the map object or location.
7. Navigate to the selected destination: press **MENU** | **ENT** | **EXIT**. Follow red course line on Map Page or compass bearing arrow on Navigation Page.
8. At destination, Arrival Alarm goes off; to clear it, press **EXIT**. Cancel navigation: press **MENU** | **MENU** | ↓ to **CANCEL NAVIGATION** | **ENT** | ← to **YES** | **ENT**.
9. Return to *Wpt 1* by *Navigate To Waypoint* or *Backtrack Trail*. **To Waypoint**: press **WPT** | **ENT** | **ENT**. Use ↑ or ↓ to select *Wpt 001*, press **ENT** | **ENT**; follow navigation displays. **Trail**: press **MENU** | **MENU** | ↓ to **MY TRAILS** | **ENT**. Press ↓ to *Trail 1* | **ENT** | ↓ to **DELETE TRAIL** | → to **NAVIGATE** | **ENT**. Press → to **REVERSE ROUTE** | **ENT** | ← to **NAVIGATE ROUTE** | **ENT**. (If arrival alarm sounds, press **EXIT**.) Follow navigation displays.
10. Back home, Arrival Alarm goes off; press **EXIT**. Cancel navigation: press **MENU** | **MENU** | ↓ to **CANCEL NAVIGATION** | **ENT** | ← to **YES** | **ENT**.
11. To turn off the unit, press and hold **PWR** key for three seconds.

## Find Your Current Position

Finding your current position is as simple as turning the unit on. Under clear sky conditions, the unit automatically searches for satellites and calculates its position in approximately one minute or less.

### NOTE:

"Clear sky" means open sky, unobstructed by terrain, dense foliage or structures. Clouds do not restrict GPS signal reception.

If for some reason satellite acquisition takes longer, you may be inside a structure or vehicle or in terrain that is blocking signal reception. To correct this, be sure you are positioned so that the unit's antenna module has as clear a view of the sky as possible, then turn the unit off and back on again.

## Moving Around the Map: Zoom & Cursor Arrow Keys

The map is presented from a bird's eye view perspective. The current zoom range shows in the lower left corner of the screen.

1. Press the **ZIN** key (zoom in) to move in closer and see greater detail in a smaller geographic area.
2. Press the **ZOUT** key (zoom out) to move farther away and see less map detail, but a larger geographic area.

When you are traveling, the map will automatically move as you move. This keeps your current location roughly centered on the screen.

You can manually pan or scroll the map northward, southward, eastward or westward by using the arrow keys, which launch the cross-hair map cursor. This allows you to look at map places other than your current position. To clear the cursor, press **EXIT**, which jumps the map back to the current position or the last known position.

### *Tip:*

Use the cursor to determine the distance from your current position (or last known position, when working indoors) to any map object or location. Simply use the arrow keys to position the cursor over the object or place. The distance, measured in a straight line, appears in the popup data box. Press **EXIT** to clear the cursor.

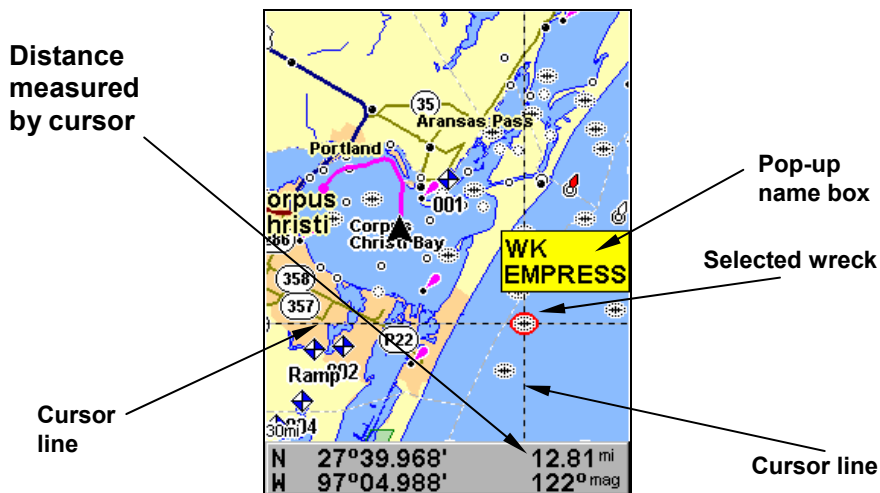

The selected wreck (the *Empress*) to the southeast is 12.81 miles away.

## Selecting Any Map Item with the Cursor

1. Use the zoom keys and the arrow keys to move around the map and find the item you wish to select.
2. Use the arrow keys and center the cursor cross-hair on the desired object. On most items, a pop-up box will give the name of the selected item.

### Tip:

This unit has an extremely handy Cursor Undo feature that lets you instantly return to the previous location you were looking at without scrolling. It works like this: Use the cursor (arrow keys) to scroll the map to some far away location or waypoint. Press **EXIT** to clear the cursor and jump back to your current position on the map. When you want to take another peek at that distant place, just press **EXIT** again. You can use this trick to toggle between your current position and your destination without a lot of scrolling.

## Searching

Now that you've seen how the unit can find where *you* are, let's search for something somewhere else. Searching is one of the most powerful features in the Lowrance GPS product line.

In this example, we'll look for the *nearest* fast-food restaurant. For more information on different types of searches, refer to Sec. 6, *Searching*.

### NOTE:

This example requires the Point of Interest (POI) database included with a high detail Mapcreate custom map.

After the unit has acquired a position:

1. Press **WPT** | ↓ to **POI-RESTAURANTS**.
2. You could search the entire restaurant category, but in this example we will narrow our search. Press → to **FAST FOOD CHAINS** | **ENT** | **ENT**.
3. The unit says it is calculating, then a list of restaurants appears, with the closest at the top of the list, and the farthest at the bottom of the list. The nearest is highlighted.

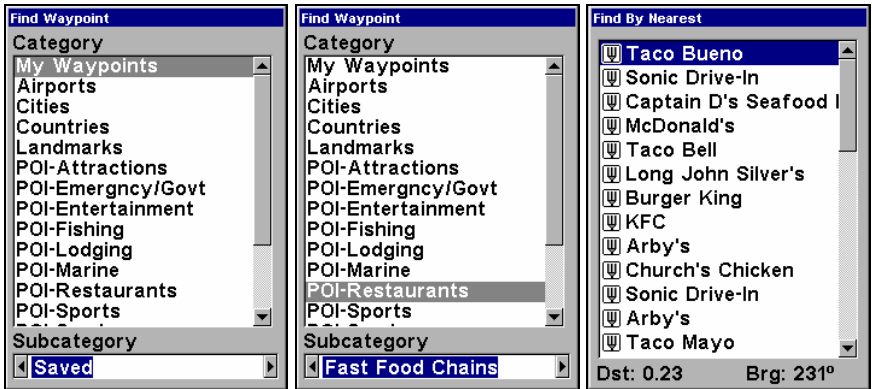

Find Waypoint Menu (left). Category Selection menu (center). List of the nearest restaurants (right).

4. If you wish, you could scroll ↑ or ↓ here to select another restaurant, but for now we will just accept the nearest one. Press **ENT**.
5. The POI information screen appears. (This is how you can use this unit as a business phone directory!) If you wanted to navigate there, you could press Enter, since the Go To waypoint command is highlighted. But we just want to see it on the map, so press → to **FIND ON MAP** | **ENT**.



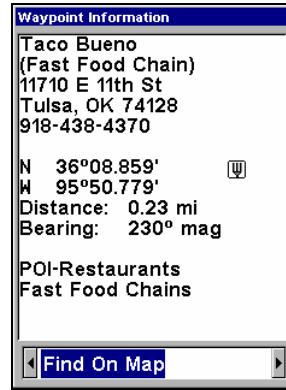

POI information screen on fast food restaurant nearest this position. Screen shows name, street address, phone number, latitude/longitude, distance to restaurant and its compass bearing. The first figure shows Go To waypoint command (left). Second figure shows Find On Map command (right).

6. The unit's map appears, with the cross-hair cursor highlighting the restaurant's POI symbol. A pop-up data box shows the POI's name. A data box at the bottom of the screen displays the location's latitude and longitude, distance and bearing.



Map screen showing Finding Waypoint, the result of a restaurant search.

7. To clear the search and return to the last page displayed, press **EXIT** repeatedly. (Before you completely exited out of the Search menus, you could have gone looking for another place.)

**NOTE:**

Search works from mapping and POI data loaded in the unit. If you do not have a high-detailed custom map (containing POI data) for the area you are searching loaded on the MMC, you may not find anything.

**Set a Waypoint**

A waypoint is simply an electronic "address," based on the latitude and longitude of a position on the earth. A waypoint represents a location, spot, or destination that can be stored in memory, then be recalled and used later on for navigation purposes.

You can create a waypoint at the cursor position on the map, or at your current position while you are navigating. You can create a waypoint at any location by manually entering the position's latitude and longitude. You can copy waypoints from your unit to your personal computer with MapCreate software. When you want to repeat a trip, these archived waypoints can be reloaded into your GPS unit.

**To create and save a Waypoint:**

These first two techniques use the Quick Save method, the fastest and easiest way to create a waypoint.

**Create Waypoint at Current Position**

While you are traveling, press **WPT|WPT**. The waypoint is saved and automatically given a name with a sequential number, such as "waypoint 003." The waypoint symbol and number appear on the map.

**NOTE:**

The Quick Save method uses the default waypoint symbol until you edit an existing waypoint and change its symbol. (Edit Waypoint Symbol is described in Sec. 4.) After you have changed a waypoint symbol, the unit will remember the one you chose and use it the *next* time you "quick save" a waypoint. To revert back to the *default* symbol, edit a waypoint and choose the original symbol, or use the Reset Options command (described in Sec. 5).

### Step 1.

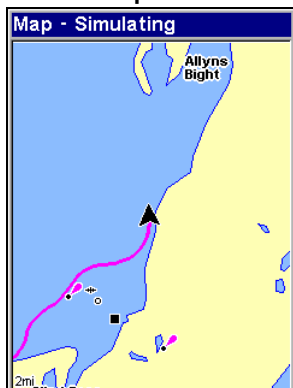

### Step 2.



### Step 3.

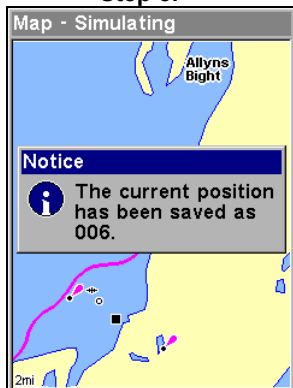

### Step 4.

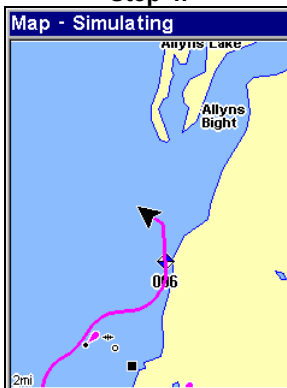

Sequence for setting a waypoint. Step 1: while traveling, *quickly* press **WPT** twice to call up Find Waypoint screen (seen in Step 2) and set a point. Step 3: message says the waypoint has been saved. Step 4: vehicle continues on its way; number waypoint symbol is visible on map.

### Create Waypoint on Map

1. Use the arrow keys to move the cursor to the place where you want to make a waypoint.
2. Press **WPT** | **WPT**. The waypoint is saved and automatically given a name with a sequential number, such as "waypoint 001." The waypoint symbol and number appear on the map.

### Create Waypoint by Entering a Position

1. Press **WPT** | **↑** to **MY WAYPOINTS** | **→** to **NEW** | **ENT**.
2. Press **↓** to **ENTERED POSITION** | **ENT** | **↑** to **CREATE** | **ENT**.

3. Press ↓ to **LATITUDE|ENT**. Enter the latitude by pressing ↑ or ↓ to change the first character, then press → to the next character and repeat until the latitude is correct. Press **ENT**.

4. Press ↓ to **LONGITUDE|ENT**. Enter the longitude by pressing ↑ or ↓ to change the first character, then press → to the next character and repeat until the longitude is correct. Press **ENT**, then **EXIT|EXIT** to return to the previous page display. The waypoint is saved and automatically given a name with a sequential number, such as "waypoint 001." The waypoint symbol and number appear on the map and in the waypoint list.

## Navigate To a Waypoint

You can select any waypoint visible on the Map Page with the cursor, then use the Navigate to Cursor command (we'll describe how later in this section.) However, you can avoid scrolling the map to pick your waypoint if you use the Find Waypoint commands:

1. Press **WPT|↑** to **MY WAYPOINTS|ENT**. To look up the nearest waypoint, press **ENT**; or, to look by name (and scroll through the entire waypoint list), press ↓ to **NAME|ENT**. For this example, look by name.

2. If your waypoint list is a long one, you can spell out the waypoint name in the **FIND BY NAME** box to search for it. (Press ↑ or ↓ to change the first character, then press → to move the cursor to the next character and repeat until the name is correct, then press **ENT** to jump to the list below.)

3. If the list is short, you can jump directly to the **FIND IN LIST** box by pressing **ENT**. Use ↑ or ↓ to select the waypoint name, press **ENT** and the waypoint information screen appears with the **Go To** command selected.

4. To begin navigating to the waypoint, press **ENT**.

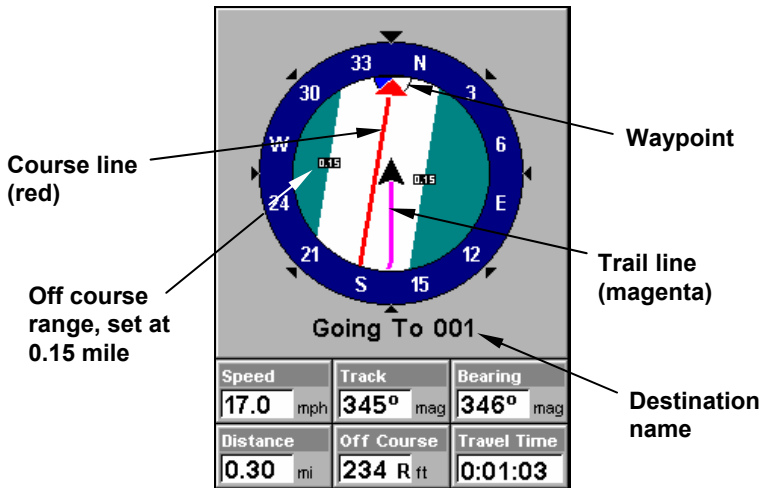

Navigation Page, navigating toward waypoint 001 and leaving a trail.

## Set Man Overboard (MOB) Waypoint

One of boating's most terrifying events is having a friend or family member fall overboard. This situation can be deadly on any body of water — fresh or salt. It's particularly dangerous at night or if you're out of sight of land. Of course, the first thing to do is remain calm and then use all standard safety procedures to rescue the person.

This unit has a man overboard feature that shows navigation data to the location where the feature was activated. To activate it, press the **ZOUT** and **ZIN** keys at the same time. Your position at the time these keys are pressed is used as the man overboard position.

### Caution:

*Saving a new "Man Overboard" waypoint will overwrite and erase the previous "Man Overboard" waypoint.*

## Navigate Back to MOB Waypoint

Find your way back to the accident position with the Navigation Page or Map Page. When MOB is activated, the Navigation Page automatically shows the compass rose with its bearing arrow pointing toward the man overboard position, and the destination name says "Going To Man Overboard." The Map Page displays a Man Overboard waypoint, represented by a human figure, and the steering arrow points where to steer to reach that position.

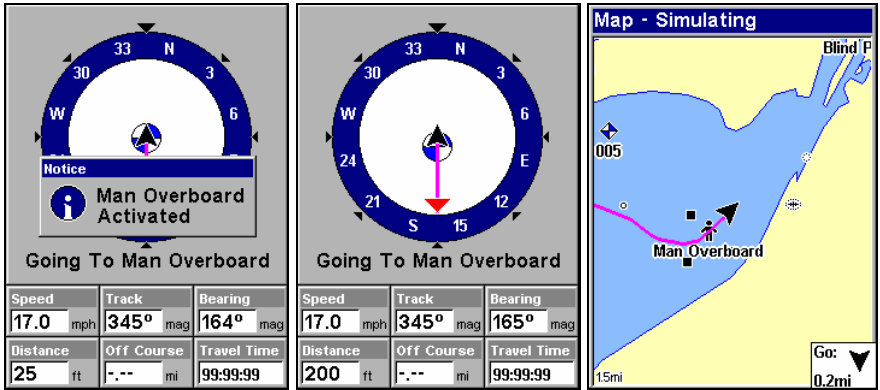

Navigating to Man Overboard: "Man Overboard activated" message (left). The Navigation Page (center) with Map Page (right). The victim is astern of the vessel; the GPS shows which direction to steer to for the rescue.

The man overboard position is also stored in the waypoint list for future reference. It can be edited the same as any other waypoint. This prevents the inadvertent loss of the current Man Overboard position.

To cancel navigation to MOB, press **MENU|MENU|↓** to **CANCEL NAVIGATION|ENT|←** to **YES|ENT**. The unit stops showing navigation information.

### Navigate to Cursor Position on Map

The **Go To CURSOR** command: navigates to the current cursor position on the map. It's a quick and handy way to navigate to anything you can see on the map display.

1. Use the cursor (controlled by the arrow keys) with the zoom in and zoom out keys to maneuver around the map until you find a location you want to go to.
2. Center the cursor over the location to select it. See the example in the following figure. (Many map items such as waypoints, Points of Interest, towns, etc. can be "selected," and appear "highlighted" with a pop-up box. Other features, such as a river or a street intersection will not appear "highlighted," but the cursor will take you to those locations just the same.)



Navigate to cursor. In this example, the cursor has selected the town of Oologah, Oklahoma.

3. Press **MENU|ENT** and the unit will begin navigating to the cursor location.

The Map Page will display a red line from your current position to the cursor position. The Navigation Page displays a compass rose showing navigation information to your destination. See the following examples.

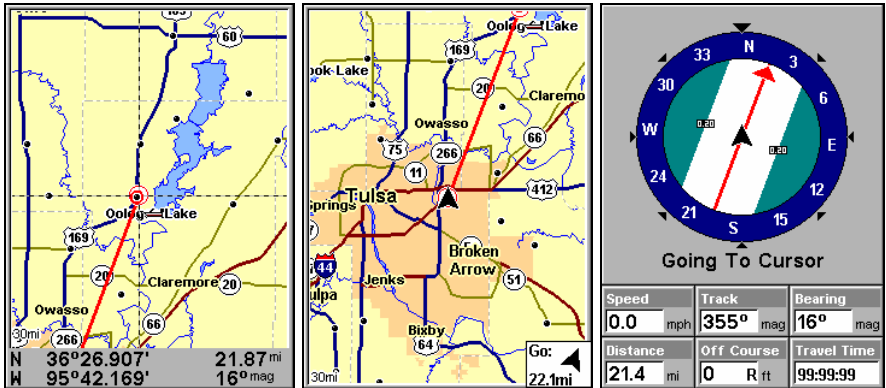

The first figure (left) clearly shows the red course line connecting your current position to your destination. The 30-mile zoom (center), shows both current position and direction to destination on screen. The Navigation Page (right) will also show navigation information.

To stop navigating to the cursor, use the Cancel Navigation command: press **MENU|MENU|↓** to **CANCEL NAVIGATION|ENT|←** to **YES|ENT**. The unit stops showing navigation information.

## Navigate to a Point of Interest

For POIs that are in view on the map, you can easily use the Navigate to Cursor command above. Use the cursor to select the POI.

The other method involves searching for POIs with the Find Waypoint command, launched with the **WPT** key. (See the searching example earlier in this section, or turn to Sec. 6, *Searching*, for detailed instructions on POI searches.)

After you have looked up an item with the Find Waypoint command, use ← or → to make sure the **Go To** command is highlighted at the bottom of the screen, then press **ENT**. The unit begins showing navigation information to the item.

To cancel navigation, press **MENU | MENU | ↓** to **CANCEL NAVIGATION | ENT | ←** to **YES | ENT**. The unit stops showing navigation information.

## Creating and Saving a Trail

A trail, or plot trail, is a string of position points plotted by the unit as you travel. It's a travel history, a record of the path you have taken. Trails are useful for repeating a journey along the same track. They are particularly handy when you are trying to retrace your trip and go back the way you came. On the screen, trails are represented by a solid line extending from the back of the current position arrow. The default color is light magenta.

The unit is set at the factory to automatically create and record a trail while the unit is turned on. The unit will continue recording the trail until the length reaches the maximum trail point setting (default is 2,000, but the unit can record trails 9,999 points long). When the point limit is reached, the unit begins recording the trail over itself.

With the default auto setting, this unit creates a trail by placing a dot (trail point) on the screen every time you change directions. (The methods used for creating a trail and the trail update rate can both be adjusted or even turned off. See Sec. 5 for *Trail Options*.)

To preserve a trail from point A to point B, you must "turn off" the trail by making it *inactive* before heading to point C or even back to point A. When the current trail is set inactive, the unit *automatically* creates and begins recording a new trail.



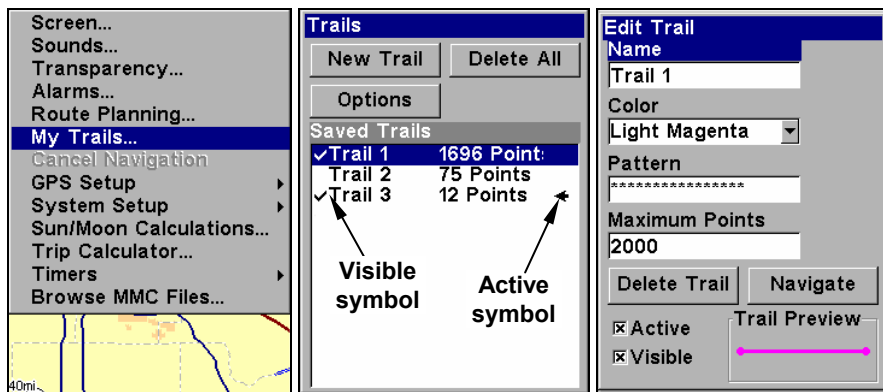

Sequence for saving a trail and beginning a new one. My Trails command (left). The Trails Menu (center). The arrow to the right of Trail 3 indicates the trail is "active," and the check to the left indicates the trail is visible on the map display. The third figure (right) shows the Edit Trail menu, with the Name command selected.

### To Save a Trail

1. Press **MENU | MENU | ↓** to **MY TRAILS | ENT.**
2. Press **↓** to the *Active Trail Name | ENT.*
3. Press **↓** to **ACTIVE | ENT.** This unchecks the Active option.
4. To return to the previous page, press **EXIT** repeatedly. As you leave the Edit Trail menu, you will notice that a new trail starts with a new sequential number. In the example figure below, the new trail is number 4, showing zero points. Note that Trail 3 is inactive, but it is still visible on the map.

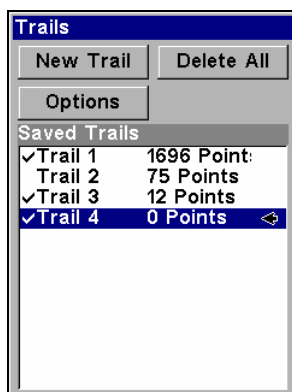

New trail, named "Trail 4," is created when Trail 3 is made inactive. Any new travel will be recorded in this trail, which is active and visible. Trails do not need to be visible in order to be active.

You can save and recall up to 10 different plot trails, which can also be copied to your MMC for archiving or for transfer to your MapCreate software.

**Tip:**

Another quick way to stop recording one trail and begin a new one is to use the New Trail command: Press **MENU|MENU|↓** to **MY TRAILS|ENT|ENT**.

**Caution:**

*You also have the option of completely turning off trail recording, under the trail Options command. However, if the Update Active Trail option is left turned off, it will cancel the automatic trail creation feature.*

## Displaying a Saved Trail

The active trail is automatically displayed on the map (the "Visible" option) with the factory default settings. You can selectively turn trail display off and on for any saved or active trail. In the Saved Trails List, visible trails have a check mark in front of the trail name.

**To turn off trail display:**

1. Press **MENU|MENU|↓** to **MY TRAILS|ENT**.
2. Press **↓** to enter the Saved Trail list, then use **↑** or **↓** to select the desired *Trail Name|ENT*.
3. Press **↓** to **VISIBLE|ENT**. To return to the previous page, press **EXIT** repeatedly.

**To turn on trail display:**

1. Press **MENU|MENU|↓** to **MY TRAILS|ENT**.
2. Press **↓** to enter the Saved Trail list, then use **↑** or **↓** to select the desired *Trail Name|ENT*.
3. Press **↓** to **VISIBLE|ENT**. To return to the previous page, press **EXIT** repeatedly.

## Navigating Trails

There are three methods for following a trail: visual trailing, navigating a trail (forward) and backtracking a trail. Try each method to see which you prefer.

Visual trailing is the simplest method. It uses only the Map Page and requires no menu commands at all. The technique works the same if you are running a trail forward (from start to end) or backward (from end to start.) However, visual trailing provides no navigation information during the trip, such as the time to your destination.

The other two methods provide a full range of navigation data and work with both the Map Page and Navigation Page. The only difference between them is "navigating a trail" follows a trail forward (from start to end) while "backtracking" follows a trail in reverse (from end to start.)

When hiking at walking speed with a hand-held GPS, we often just use visual back trailing because it is a bit better at following each little turn on a foot path. At faster speeds, such as the highway or on the water, the Navigate Trail and Backtrack Trail commands are handy.

### **Visual Trailing**

1. On the Map Page, zoom (**ZIN** or **ZOUT**) so your trail is visible.
2. Begin moving and watch the Map Page. Simply walk or steer so that your current position arrow traces along the trail you have just made.

#### **Tip:**

Generally, when using this method, the smaller the zoom range, the more accurately you will be able to steer along the trail.

### **Navigate a Trail (forward)**

The following figures illustrate the menu sequence for navigating a trail.

1. Press **MENU | MENU | ↓** to **MY TRAILS | ENT**.
2. Press **↓** to enter the Saved Trail list, then use **↑** or **↓** to select the desired *Trail Name* | **ENT**.
3. Press **↓** to **DELETE TRAIL | →** to **NAVIGATE | ENT | ENT**.

The unit begins showing navigation information along the trail.

#### **NOTE:**

If you are already located at or near the beginning of your trail, the arrival alarm will go off as soon as you hit Enter. Just press **EXIT** to clear the alarm and proceed.

5. Now, begin moving and follow your unit.
6. When you reach your destination, be sure to cancel your navigation: press **MENU | MENU | ↓** to **CANCEL NAVIGATION | ENT**. The unit asks if you're sure; press **← | ENT**.

Figure 1.

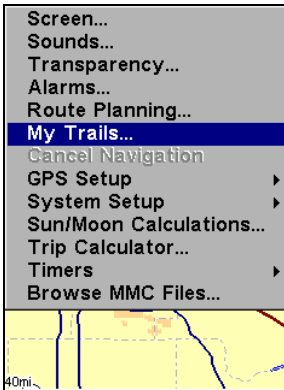

Figure 2.

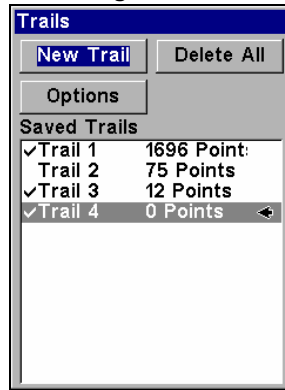

Figure 3.

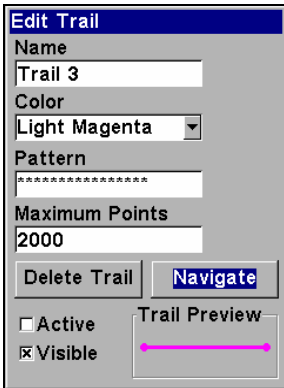
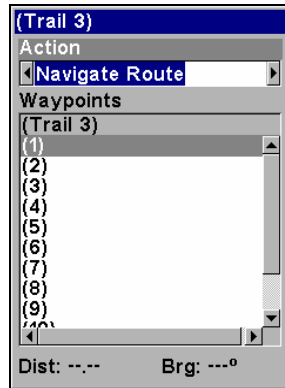

Figure 4.



Navigate a trail menu sequence: Fig. 1, My Trails command. Fig. 2, Trails Menu. Fig. 3, Edit Trail Menu. Fig. 4, Edit Route Menu with Navigate Route command highlighted for Trail 1. A trail is always converted to a "route" when you navigate the trail.

On the Map Page, the trail you are navigating is represented by a magenta line (if the visible trail option is on). The course you are following (the trail converted to a route) is represented by a red line. The magenta trail line overlays the red course line. To see the red course line, you must turn off the visible trail option. The Navigation Page will show only the red course line, unless you are recording a new trail. The bearing arrow on the compass rose points to the next waypoint on the trail.

As you travel, the arrival alarm will go off when you near a trail waypoint, and the bearing arrow on the compass rose will swing around and point to the next trail waypoint. Press **EXIT** to clear the alarm.

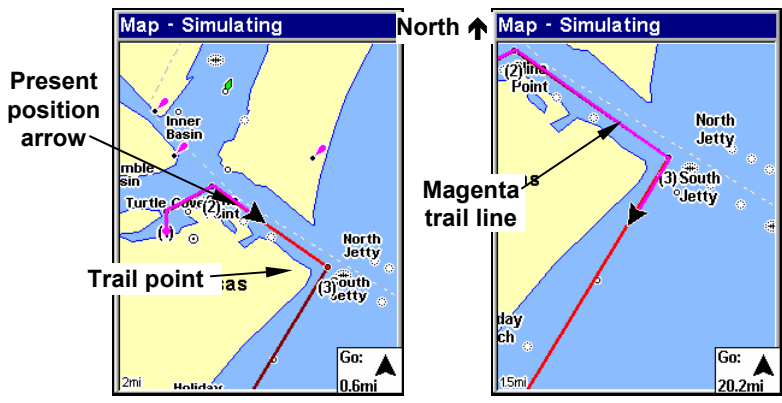

Navigate trail, map views: driver (left) is heading southeast straight toward trail point 3. Driver (right) has reached point 3 and has turned southwest to follow the trail.

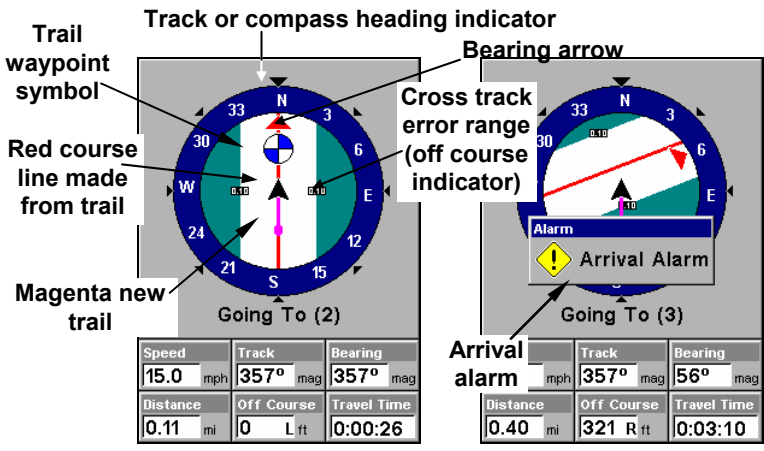

Navigate trail, navigation page (compass rose) views: driver (left) is heading north straight toward trail point 2; bearing arrow shows the trail point is 357 degrees (straight ahead.) Driver (right) has reached trail point 2 and must turn northeast to follow the trail. Arrival alarm goes off and bearing arrow swings around to say turn right (east), toward the next waypoint, trail point 3. The unit now shows navigation information to point 3, which is 0.40 miles away.

**Backtracking a trail:**

1. Press **MENU | MENU | ↓** to **MY TRAILS | ENT.**
2. Press **↓** to enter the Saved Trail list, then use **↑** or **↓** to select the desired *Trail Name* | **ENT.**
3. Press **↓** to **DELETE TRAIL | →** to **NAVIGATE | ENT.**

4. Press **→** to **REVERSE ROUTE|ENT|←** to **NAVIGATE ROUTE|ENT**. The unit begins showing navigation information along the trail, in reverse.

**NOTE:**

If you are already located at or near the end of your trail, the arrival alarm will go off as soon as you hit Enter. Just press **EXIT** to clear the alarm and proceed.

5. Now, begin moving and follow your unit.

6. When you reach your destination, be sure to cancel your navigation: press **MENU|MENU|↓** to **CANCEL NAVIGATION|ENT**. The unit asks if you're sure; press **←|ENT**.

## **Transfer Custom Maps and GPS Data Files**

### **Custom Maps:**

Custom maps work only from the MMC card or SD card. When a card containing a Custom Map File is loaded into the unit, the unit automatically loads the map into memory when the unit is turned on.

Instructions for copying Custom Map Files to an MMC are contained in the instruction manual for your MMC card reader and Mapcreate software. For instructions on inserting an MMC into the unit, *see Sec. 2, Installation/Accessories*.

### **GPS Data files:**

GPS Data Files contain waypoints, routes, trails and event marker icons. Instructions for copying GPS Data Files between your computer and an MMC are contained in the instruction manual for your MMC card reader and Mapcreate software.

GPS data automatically recorded in the unit's internal memory must be saved to the MMC (as a GPS Data File) in order to store it on your personal computer. GPS Data Files stored on an MMC must be copied from the card to the unit's internal memory before the unit can read them. Here's how:

1. Insert the MMC into your unit. Press **MENU|MENU|↓** to **SYSTEM SETUP|ENT|↓** to **TRANSFER MY DATA|ENT** and the screen below appears.

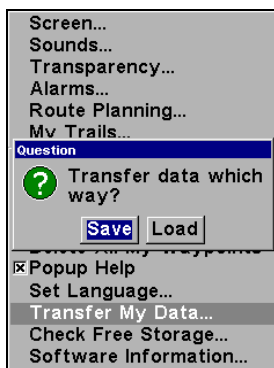

The Transfer My Data submenu asks if you want to save data to the MMC or load data from the MMC into the unit's memory.

2. The Transfer My Data menu includes a message which tells you if an MMC is present or not. If no MMC is present, you must first insert a card into the unit in order to activate the Load or Save commands.

To transfer data *from the unit to the MMC*: press **ENT** (for **SAVE**.)

To transfer data *from the MMC to the unit*: press **→** to **LOAD** | **ENT**.

3. **Saving to MMC**: To accept the default name "Data" for the GPS Data File, press **↓** to **SAVE DATA** | **ENT**. If you wish to rename the file (as shown in the following figures), press **ENT** to activate the selection box. Press **↑** or **↓** to change the first character, then press **→** to the next character and repeat until the name is correct. Then, press **ENT** | **↓** to **SAVE DATA** | **ENT**.

The unit will display first a progress then a completion message when the data transfer is finished. To return to the Page view, repeatedly press **EXIT**.

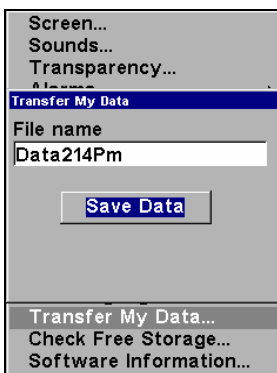
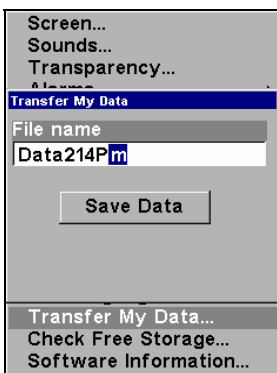
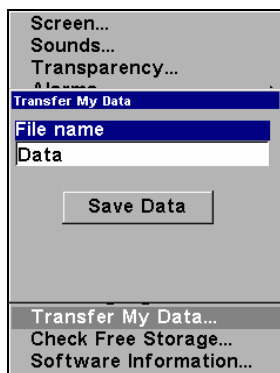

These figures (left to right) show the menu sequence for naming and saving a GPS Data File from the unit's memory to an MMC.

4. **Loading to unit memory:** There may be more than one GPS Data File (\*.USR) on the card. To select a file, press **ENT** to activate the selection box, use **↓** or **↑** to highlight the file, then press **ENT** to accept the selection. Next, press **↓** to **LOAD DATA** | **ENT**. The unit will display a completion message when the data transfer is finished. To return to the Page view, press **EXIT** | **EXIT** | **EXIT** | **EXIT**.

Figure 1.

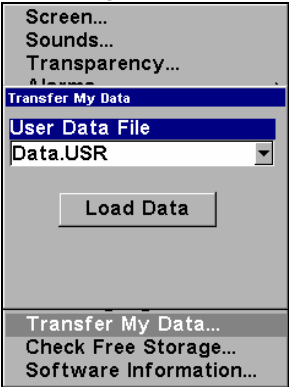

Figure 2.

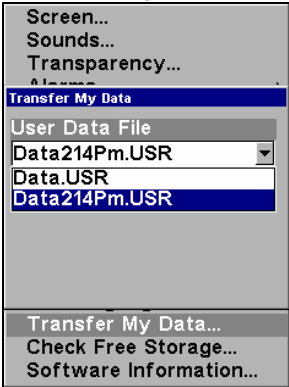

Figure 3.

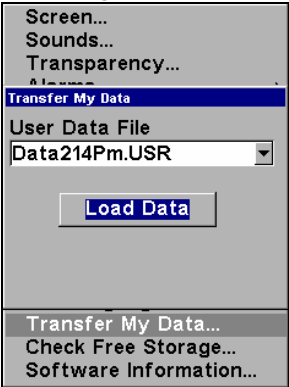
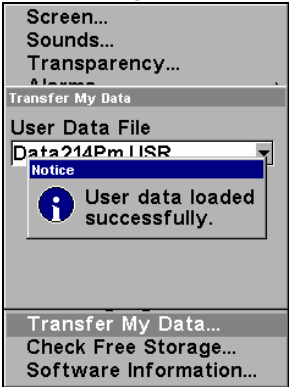

Figure 4.



These figures show the menu sequence for loading a GPS Data File from an MMC into the unit's memory.

### Cancel Navigation

You can turn off any of the navigation commands after you reach your destination or at any other time by using the Cancel Navigation command. Press **MENU** | **MENU** | **↓** to **CANCEL NAVIGATION** | **ENT** | **←** to **YES** | **ENT**.



# Section 4:

## Advanced GPS Operations

### Find Distance from Current Position To Another Location

1. While on the Map Page press: **MENU** | ↓ to **FIND DISTANCE** | **ENT**.
2. Center your cursor over the position you want to find the distance to. A rubber band line appears, connecting your current position to the cursor's location. The distance along that line will appear in a pop-up box. The box also shows the bearing to the point you're measuring to.
3. Press **EXIT** | **EXIT** to return to regular operation.

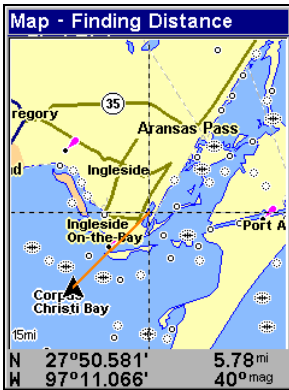

The distance from the boat's current position to the cove is 5.78 miles (left). Distance from Houston to New Orleans is 316.9 miles (right).

### Find Distance from Point to Point

You can also measure distance between two other points on the map.

1. While on the Map Page press: **MENU** | ↓ to **FIND DISTANCE** | **ENT**.
2. Center your cursor over the first position. (A rubber band line appears, connecting your *current* position to the cursor's location.) Press **ENT** to set the first point, and the rubber band line disappears.
3. Move the cursor to the second position. The rubber band line reappears, connecting the first point you set to the cursor. The distance along that line will appear in the pop-up box.
4. Press **EXIT** to clear the command and return to the page screen. (Press **EXIT** once more to clear the cursor.)

# Icons

Icons are graphic symbols used to mark some location, personal point of interest or event. They can be placed on the map screen, saved and recalled later for navigation purposes. These are sometimes referred to as event marker icons. This unit has 42 different symbols you can pick from when creating an icon.

Icons are similar to waypoints, but they do not store as much information (like names) as waypoints do. You can't use a menu to navigate to icons as you can with waypoints. (But, you *can* use the map cursor and navigate to any icon on the map.)

You can create an icon at the cursor position on the map, or at your current position while you are navigating.

## Create Icon on Map

1. Use the arrow keys to move the cursor to the place where you want to make an icon.
2. Press **ENT** and the screen shows a "Select Icon Symbol" menu.
3. Press **←** or **↑** or **→** or **↓** to select your icon symbol, then press **ENT**. The icon appears on the map. Press **EXIT** to clear the cursor.

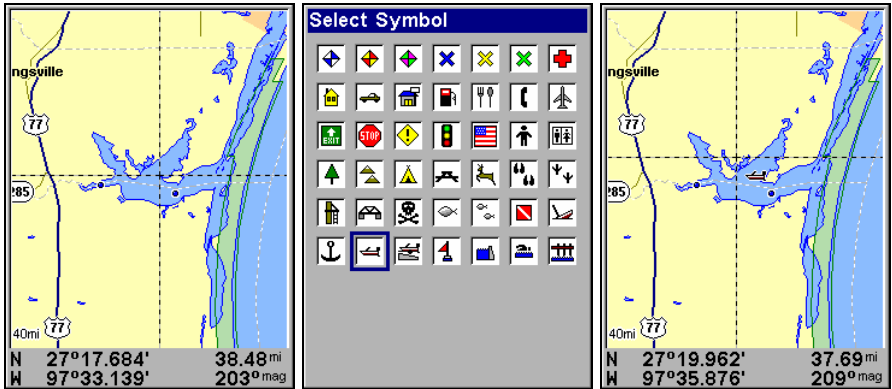

Cursor selects icon location (left). Select Icon Symbol menu (center). Boat Ramp icon on map (right). (Cursor has been moved for clarity.)

## Create Icon at Current Position

1. While you are traveling, press **ENT** and the screen shows a "Select Icon Symbol" menu.
2. Press **←** or **↑** or **→** or **↓** to select your icon symbol, then press **ENT**. The icon appears on the map.

## Delete an Icon

You can delete all the icons at one time, you can delete all icons represented by a particular symbol, or you can use the cursor to delete a selected icon from the map.

1. Press **MENU** | ↓ to **DELETE MY ICONS** | **ENT**.
2. Press ↓ to **DELETE ALL ICONS**, **DELETE BY SYMBOL**, or **DELETE FROM MAP** and press **ENT**.

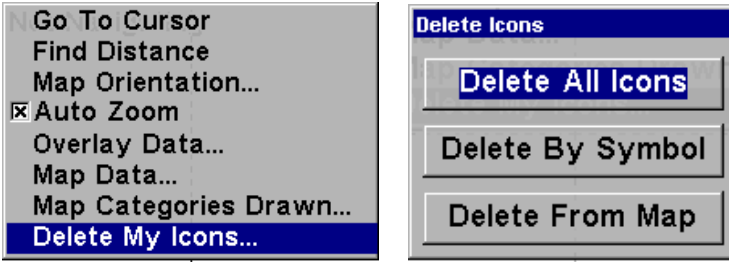

Delete icons menu.

The Delete All Icons command will ask if you are sure. Press ← to **YES** | **ENT**. All icons will be deleted from the map.

The Delete by Symbol command will launch the Select Symbol menu. Press ← or ↑ or → or ↓ to select the icon symbol to delete, then press **ENT**. A message appears saying all icons with the selected symbol have been deleted.

The Delete From Map command will prompt you to move the cursor over an icon to select it. After selecting the icon, press **ENT** and it disappears from the map.

## Navigate to an Icon

Use the Navigate to Cursor command, and use the cursor to select the desired icon on the map.

1. Use arrow keys to center cursor cross-hair over the icon.
2. To navigate to the selected icon location: press **MENU** | **ENT** | **EXIT**. Follow course line on the Map Page or the compass bearing arrow on the Navigation Page.

## Routes

A route is a series of waypoints, linked together in an ordered sequence, that's used to mark a course of travel. You can visualize a route as a string of beads: The beads represent waypoints and the string represents the course of travel connecting waypoint to waypoint.

The course from one waypoint to the next is a leg; routes are composed of one or more legs. The legs of all GPS routes are based on straight lines between waypoints.

A route provides the automatic capability to navigate through several waypoints without having to reprogram the unit after arriving at each waypoint. Once programmed into the GPS unit, a route provides the option of navigating forward through the route waypoints or in reverse order (you can even begin navigating in the middle of a route!)

### **Create and Save a Route**

You have the option of creating and editing a route in the unit, or you can make a route on your computer with our Mapcreate software.

#### **PC-created Routes**

MapCreate is the easiest method for preparing a route, simply because your PC's larger screen, keyboard and mouse are easier to manipulate than the unit.

To load a MapCreate route into the unit, follow instructions in MapCreate's manual for creating a route and saving it as part of a GPS Data File (file format \*.usr). Copy the GPS Data File to an MMC and insert the MMC in the unit. (See Sec. 2 for instructions on installing MMCs. To load the GPS Data File into the unit's memory, see the entry on *Transfer Custom Maps & GPS Data Files* in Sec. 3, *Basic GPS Operations*.)

#### **Routes Created in the Unit**

You can create a route by selecting existing waypoints from the waypoint list or you can set a series of route waypoints on the map with cursor arrows and the Enter key. In this example, we'll create a route from the map.

1. From the **NAVIGATION PAGE**, press **MENU|ENT** or from the **MAP PAGE**, press **MENU|MENU|↓** to **ROUTE PLANNING|ENT**.

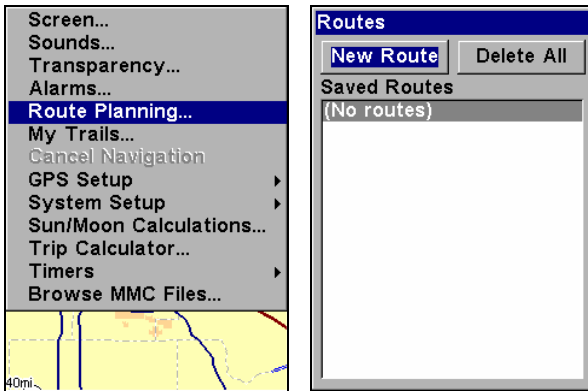

**Route Planning highlighted on Main Menu (left), will open the Route List screen (right).**

2. If necessary, press  $\uparrow$  to select **NEW ROUTE**, then press **ENT**. (To add to an existing route, press  $\downarrow$  or  $\uparrow$  to *route name* | **ENT**.)
3. Press  $\downarrow$  to **(ROUTE END)** | **ENT** |  $\downarrow$  to **ADD FROM MAP** | **ENT**. The Map Page appears with the cursor showing.

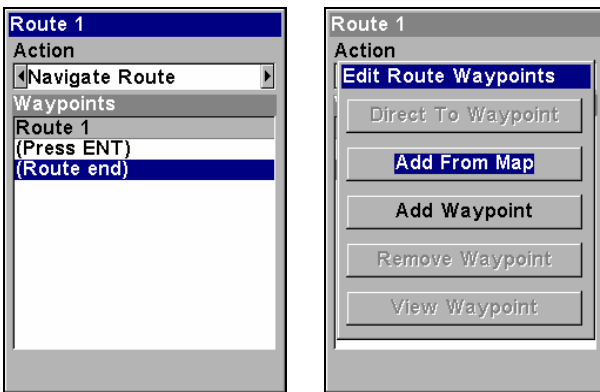

**Edit Route menu (left). Edit Route Waypoints menu (right), with Add From Map command selected.**

4. Use the Zoom keys and arrow keys to move the map and cursor until the cursor is centered on the spot where you want your route to begin. (If you are starting at your current position or the current cursor position, you are already at the starting spot.)
5. Set the first route waypoint: press **ENT**. In this example, we moved to the entrance of the cove where our boat was docked to start out route a promising fishing spot next to an oil platform. (Creating this example route is illustrated in the following figures.)

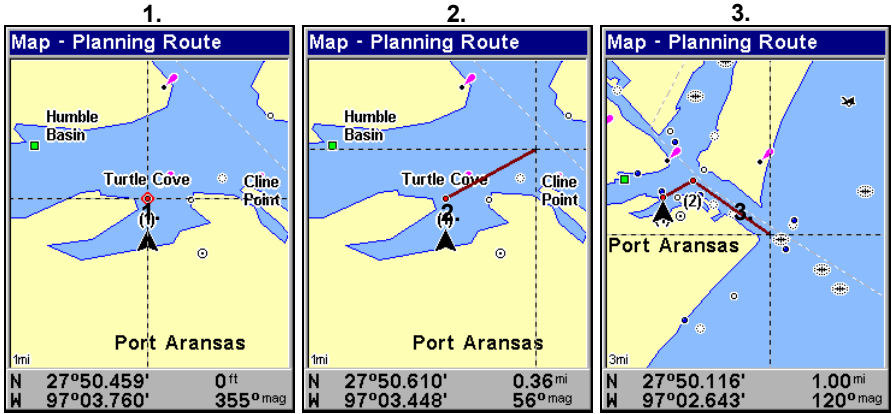

Route creation sequence (left to right): Fig. 1. Set route waypoint (1) at the cove entrance. Fig. 2. Move cursor northeast to set point (2) at channel entrance. Fig. 3. With point (2) set, move cursor southeast to mark channel exit with waypoint (3). In figures 2 and 3, notice the rubber band line extending from the previously set waypoint to the cursor. This line will become the course for the route.

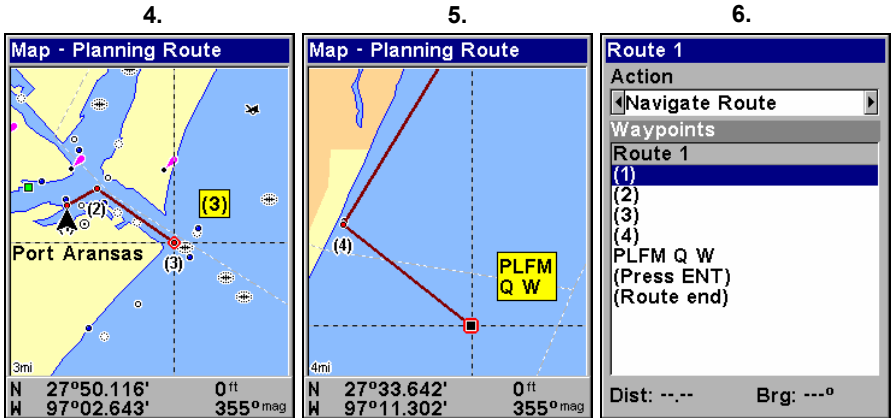

Route creation sequence, continued: Fig. 4. Point (3) set at channel mouth. Fig. 5. Waypoint (4) set further south along the beach, at a recognizable landmark (Bob Hall Pier). Waypoint PLFM Q W ends the route at an oil platform some distance from the shore. Fig. 6. Press **EXIT** to save the route and you return to this screen.

6. Move the cursor to the next point in the route, a spot where you need to turn or change direction, and press **ENT** to set the next waypoint.

7. Repeat step six until the route reaches your destination.

8. To save your route, press **EXIT**. The unit reverts to the Edit Route screen, with the route automatically named "Route 1" and stored in the unit's internal memory.

You can edit the route and run other commands, but if you are finished with the route for now, return to the last page displayed by pressing **EXIT** repeatedly.

#### **NOTE:**

When adding waypoints to an existing route, the inserted waypoints will appear in the route in front of the waypoint you have selected in the Edit Route menu. To insert waypoints at the end of the route, make sure to select (**ROUTE END**) before adding them.

### **Delete a Route**

1. From the **NAVIGATION PAGE**, press **MENU | ENT** or from the **MAP PAGE** press **MENU | MENU | ↓** to **ROUTE PLANNING | ENT**.
2. Press **↓** to *route name* | **ENT**.
3. Press **→** to **DELETE ROUTE | ENT | ←** to **YES | ENT**.

#### **Tip:**

You can also delete all routes at once:

1. From the **NAVIGATION PAGE**, press **MENU | ENT** or from the **MAP PAGE** press **MENU | MENU | ↓** to **ROUTE PLANNING | ENT**.
2. Press **→** to **DELETE ALL | ENT | ←** to **YES | ENT**.

### **Edit a Route Name**

You can edit the route name if you wish.

1. From the **NAVIGATION PAGE**, press **MENU | ENT** or from the **MAP PAGE** press **MENU | MENU | ↓** to **ROUTE PLANNING | ENT**.
2. Press **↓** to *route name* | **ENT | →** to **EDIT ROUTE NAME | ENT**.
3. Press **↑** or **↓** to change the first character, then press **→** to move the cursor to the next character and repeat until the name is correct, then press **ENT**. Return to the previous page by pressing **EXIT** repeatedly.

### **Edit Route Waypoints**

You can edit the route by adding and removing waypoints.

1. From the **NAVIGATION PAGE**, press **MENU | ENT** or from the **MAP PAGE** press **MENU | MENU | ↓** to **ROUTE PLANNING | ENT**.
2. Press **↓** to *route name* | **ENT | ↓** to Route Waypoints List. Use **↓** and **↑** to select a waypoint, then press **ENT**.

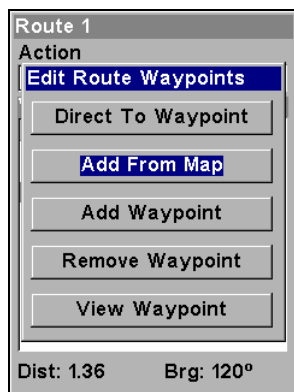

### Edit Route Waypoints menu.

3. Use ↓ and ↑ to select a command from the Edit Route Waypoints menu and press **ENT**. Add From Map lets you insert a waypoint in the route by clicking on a map location with the cursor. Add Waypoint calls up the Waypoint List so you can insert a waypoint from the list. Remove Waypoint will delete the waypoint from the route. View Waypoint will show you where the selected waypoint is on the map.

#### NOTE:

When adding waypoints to a route, the inserted waypoints will appear in the route in front of the waypoint you have selected. To insert waypoints at the end of the route, make sure to select **(ROUTE END)** before adding them.

#### Navigate a Route

1. From the **NAVIGATION PAGE**, press **MENU | ENT** or from the **MAP PAGE**, press **MENU | MENU | ↓** to **ROUTE PLANNING | ENT**.



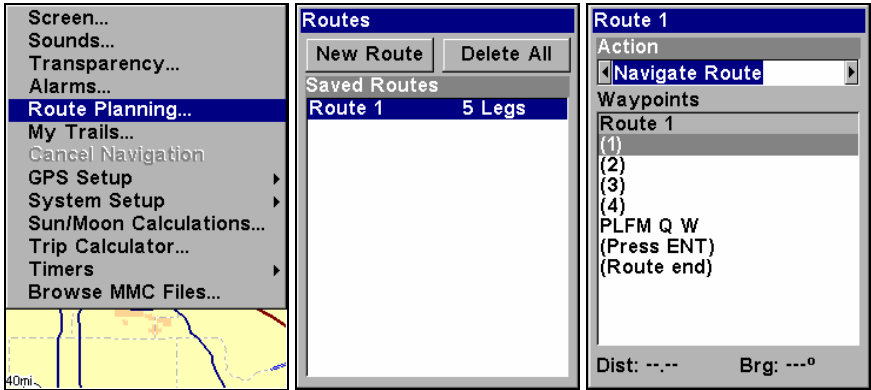

Route Planning command on Main Menu (left). Routes menu (center). Edit Route menu (right). Navigate Route command is selected.

2. Press ↓ to select *route name* | ENT | ENT.
3. Upon arrival at your destination, cancel navigation: press MENU | MENU | ↓ to CANCEL NAVIGATION | ENT | ← to YES | ENT.

The following figures show what the Navigation Page and Map Page look like while navigating a route.

### Navigate a Route in Reverse

Here's how you run a route backward, from the end waypoint to the beginning waypoint:

1. From the NAVIGATION PAGE, press MENU | ENT or from the MAP PAGE, press MENU | MENU | ↓ to ROUTE PLANNING | ENT.
2. Press ↓ to select *route name* | ENT | → to REVERSE ROUTE | ENT | ← to NAVIGATE ROUTE | ENT.
3. Upon arrival at your destination, cancel navigation: Press MENU | MENU | ↓ to CANCEL NAVIGATION | ENT | ← to YES | ENT.

Figure 1.



Figure 2.

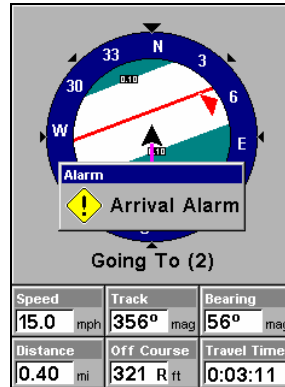

Navigating along a route: Fig. 1 shows the Navigation Page at the start of a route, heading straight for the first waypoint (Wpt 1). In Fig. 2, the traveler has arrived at Wpt 1; the arrival alarm has been triggered and the bearing arrow on the compass rose has turned to point toward Wpt 2, off to the northeast.

Figure 3.

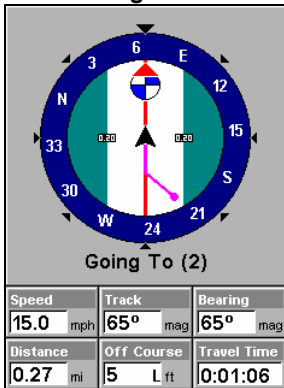
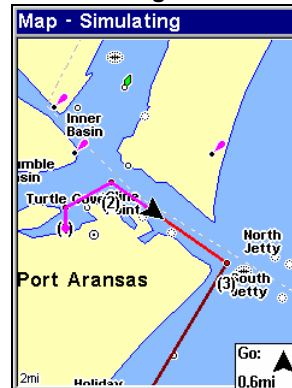

Figure 4.



In Fig. 3 the traveler has turned northeast on his new course and is heading straight for Wpt 2, which is 0.27 miles away. Fig. 4 shows route navigation on the Map Page. In this figure, the traveler has reached Wpt 2 and is starting on the leg between Wpts 2 and 3.

## Trails

### Delete a Trail

This is the command used to erase or delete a trail: Press **MENU|MENU|↓** to **MY TRAILS|ENT|↓** to *trail name*|**ENT|↓** to **DELETE TRAIL|ENT|←** to **YES|ENT**.

### Tip:

You can also delete all trails at once:

1. Press **MENU | MENU | ↓** to **MY TRAILS | ENT**.
2. Press **→** to **DELETE ALL | ENT | ←** to **Yes | ENT**.

### Edit a Trail Name

To edit a trail name: press **MENU | MENU | ↓** to **MY TRAILS | ENT | ↓** to *trail name* | **ENT | ENT**. Press **↑** or **↓** to change the first character, then press **→** to the next character and repeat until the name is correct. Press **ENT** then **EXIT** repeatedly to return to the previous page display.

### Tip:

You can quickly call up the Edit Trail menu by selecting a trail on the map with the cursor. Simply move the cursor over a trail and a pop-up box appears. Press **WPT** and the Edit Trail menu opens.

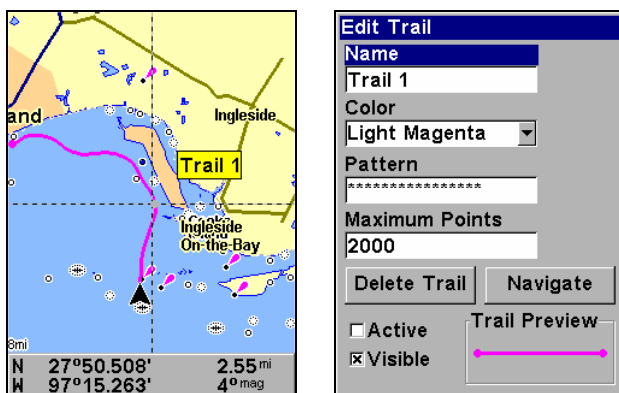

Trail selected with map cursor (left). The box at the bottom of the screen shows distance and bearing from current position to the selected point on the trail. The Edit Trail menu (right).

### Edit a Trail Color

To edit a trail color: press **MENU | MENU | ↓** to **MY TRAILS | ENT | ↓** to *trail name* | **ENT | ↓** to **COLOR | ENT**. Press **↑** or **↓** to select a color style, then press **ENT**. Press **EXIT** repeatedly to return to the previous page display.

### Edit a Trail Pattern

To edit a trail pattern: press **MENU | MENU | ↓** to **MY TRAILS | ENT | ↓** to *trail name* | **ENT | ↓** to **PATTERN | ENT**. Press **↑** or **↓** to change the first character, then press **→** to the next character and repeat until the pattern is correct. Press **ENT**, then **EXIT** repeatedly to return to the previous page display.

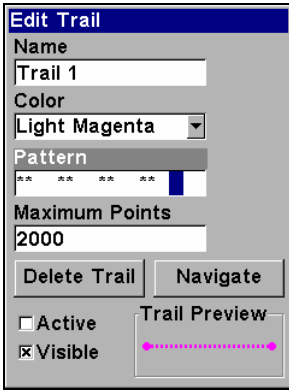

Edit Trail Menu with Pattern option selected (left). Edited trail with dotted line pattern (right).

## Utilities

Utilities are useful tools for traveling or for outdoor activities.

### Alarm Clock

To get to the alarm clock menu: press **MENU | MENU | ↓** to **TIMERS | ENT | ↓** to **ALARM CLOCK | ENT**.

### Sun/Moon Rise & Set Calculator

To get to the Sun/Moon menu: press **MENU | MENU | ↓** to **SUN/MOON CALCULATIONS | ENT**.

### Trip Calculator

To get to the Calculator menu: press **MENU | MENU | ↓** to **TRIP CALCULATOR | ENT**.

### Trip Down Timer

To get to the Down Timer menu: press **MENU | MENU | ↓** to **TIMERS | ENT | ↓** to **DOWN TIMER | ENT**.

### Trip Up Timer

To get to the Up Timer menu: press **MENU | MENU | ↓** to **TIMERS | ENT | ENT**.

## Waypoints

### Delete a Waypoint

To delete a waypoint from the waypoint list: press **WPT | ↑** to **MY WAYPOINTS | ENT | ENT | ENT | ↓** to *waypoint name* | **ENT | →** to **DELETE WAYPOINT | ENT | ←** to **Yes | ENT**. To return to the previous page, press **EXIT | EXIT**.

To delete a waypoint from the map:

1. Use the arrow keys to select the waypoint with the cursor.
2. Press **WPT**|→ to **DELETE WAYPOINT**|**ENT**|← to **YES**|**ENT**. To return to the previous page and clear the cursor, press **EXIT**.

To delete all waypoints at one time: press **MENU**|**MENU**|↓ to **SYSTEM SETUP**|**ENT**|↓ to **DELETE ALL MY WAYPOINTS**|**ENT**|← to **YES**|**ENT**. To return to the previous page, press **EXIT**|**EXIT**.

## **Edit a Waypoint**

### **Waypoint Name**

To edit waypoint name:

1. Press **WPT**|↑ to **MY WAYPOINTS**|**ENT**|**ENT**|**ENT**|↓ to *waypoint name*|**ENT**|→ to **EDIT WAYPOINT**|**ENT**|**ENT**.
2. Press ↑ or ↓ to change the first character, then press → to the next character and repeat until the name is correct. Press **ENT** then **EXIT** repeatedly to return to the previous page display.

### **Waypoint Symbol**

To edit waypoint symbol:

1. Press **WPT**|↑ to **MY WAYPOINTS**|**ENT**|**ENT**|**ENT**|↓ to *waypoint name*|**ENT**|→ to **EDIT WAYPOINT**|**ENT**|↓ to **ALTITUDE**|→ to **CHOOSE SYMBOL**|**ENT**.
2. Use arrow keys to select desired symbol and press **ENT**. To return to the previous page, press **EXIT** repeatedly.

### **Waypoint Position**

To edit waypoint position:

1. Press **WPT**|↑ to **MY WAYPOINTS**|**ENT**|**ENT**|**ENT**|↓ to *waypoint name*|**ENT**|→ to **EDIT WAYPOINT**|**ENT**.
2. Latitude: press ↓ to **LATITUDE**|**ENT**. Press ↑ or ↓ to change the first character, then press → to the next character and repeat until the latitude is correct. Press **EXIT**.
3. Longitude: press ↓ to **LONGITUDE**|**ENT**. Press ↑ or ↓ to change the first character, then press → to the next character and repeat until the longitude is correct. Press **EXIT**.
4. When latitude and longitude are correct, return to the previous page: press **EXIT** repeatedly.

## Selecting a Waypoint

To select a waypoint on the map (for navigating to, for editing, etc.,) use the arrow keys and center the cursor over the waypoint. A highlighted halo will appear around the waypoint.

## Set a Waypoint by Average Position

This feature sets a waypoint at the current position after taking several position readings and averaging them. This boosts waypoint position accuracy by helping to eliminate errors caused by atmospheric conditions and other factors.

1. Press **WPT** | **↑** to **MY WAYPOINTS** | **→** to **NEW** | **ENT**.
2. Press **↓** or **↑** to **AVERAGE POSITION** | **ENT** | press **↑** to **CREATE** | **ENT**.
3. Wait while the unit takes points to average for the position. (The greater the number of points, the greater the accuracy.) When the desired number of points accumulates, press **ENT** to create and save the waypoint.
4. The Edit Waypoint menu appears. You can simply save the waypoint by pressing **EXIT** | **EXIT** or you can edit the waypoint.

## Set a Waypoint by Projecting a Position

This feature sets a waypoint at a point located a specific distance and bearing from a reference position. The reference position can be selected from your waypoint list, a map feature or from the Points of Interest list.

1. Press **WPT** | **↑** to **MY WAYPOINTS** | **→** to **NEW** | **ENT**.
2. Press **↓** to **PROJECTED POSITION** | **ENT** | **↑** to **CREATE** | **ENT**.
3. Press **↓** to **CHOOSE REFERENCE** | **ENT**. Use **↑** and **↓** to select a waypoint, map feature or Point of Interest. When the point has been selected, press **ENT** and the point's position appears as the reference position.
4. Press **↓** to **DISTANCE** | **ENT**. Press **↑** or **↓** to change the first character, then press **→** to the next character and repeat until the distance is correct. Press **ENT**.
5. Press **↓** to **BEARING** | **ENT**. Press **↑** or **↓** to change the first character, then press **→** to the next character and repeat until the bearing is correct. Press **ENT**.
6. Press **↑** to **PROJECT** | **ENT**. The Edit Waypoint menu appears. You can simply save the new projected waypoint by pressing **EXIT** | **EXIT** or you can edit the waypoint. (Press **EXIT** | **ENT** if you want to immediately begin navigating to the new waypoint.)

# Section 5:

## System & GPS Setup Options

### Alarms

This unit has several GPS alarms. The factory default setting has all of these but the anchor alarm turned on. You can turn the alarms off and on and change their distance settings.

You can set an arrival alarm to flash a warning message and sound a tone when you cross a preset distance from a waypoint. For example, if you have the arrival alarm set to .1 mile, then the alarm will flash a message when you come within .1 mile of the recalled waypoint.

The off course alarm warns you when your track drifts too far to the right or left of the course line to the waypoint. For example, if the alarm is set to .1 mile, then the alarm flashes a message if you drift .1 of a mile or more to the right or left of the line to the waypoint.

The anchor alarm is triggered when you drift outside of a preset radius. Again, using the .1 mile as an example, if you're anchored and your boat moves more than .1 of a mile, the alarm will flash a message and sound a tone.

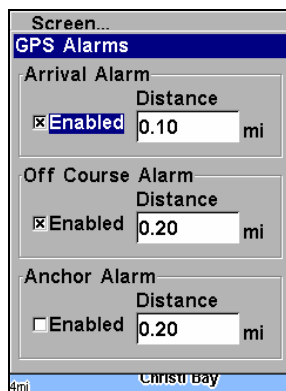
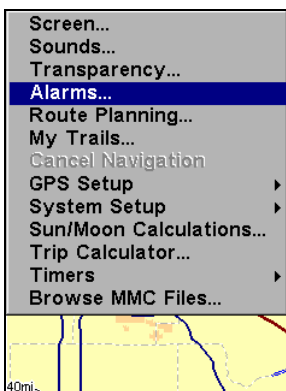

Alarms command (left). Alarm menu (right).

To change alarm settings:

1. Press **MENU | MENU | ↓** to **ALARMS | ENT | ENT**.
2. Scroll **↓** or **↑** to select the desired category, then press **ENT** to check or clear the Enabled box. This turns the alarm on (checked) or off (unchecked.)

3. To change distance settings, scroll ↓ or ↑ to select the desired category, then press → |ENT to activate the distance dialog box. Press ↑ or ↓ to change the first character, then press → to the next character and repeat until the name is correct.

4. When your adjustments are finished, return to the last page displayed by repeatedly pressing **EXIT**.

### **IMPORTANT ALARM NOTES:**

**Anchor Alarm** - The anchor alarm may be triggered even when you're sitting still. This typically happens when using small (less than .05 mile) anchor alarm ranges.

**Arrival Alarm** - If you set the arrival alarm's distance to a small number and you run a route (see the Navigate Routes segment), this unit may not show navigation data to the next waypoint, once you arrive at the first one, since you may not be able to come close enough to the first waypoint to trip the arrival alarm.

## **Check MMC Files and Storage Space**

To check MMC Files:

Press **MENU** | **MENU** | ↓ to **BROWSE MMC FILES** | **ENT**. Press ↓ to **MMC CARD INFO** | **ENT** to see the free space on the card.

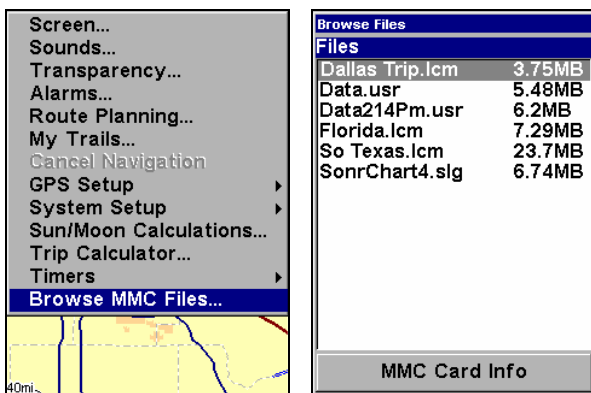

**Main Menu (left). MMC File Browser (right).**

## **Communications Port Configuration**

The unit has one NMEA 0183 version 2.0 compatible communication port, or com port for short. The Com Port Menu, which is accessed from the System Setup Menu, lets you configure the communications port to send or receive data to another electronic device, such as an autopilot. The com port can be used for NMEA Binary data transfer.



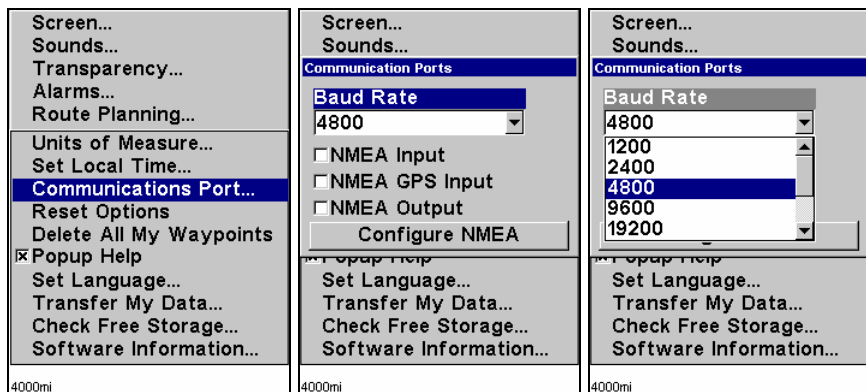

Menus for changing Com Port settings.

For connectors and wiring information for another device, see page 15. For assistance in configuring the unit to communicate with another device, consult the factory; customer service phone numbers are in the back of this manual. Also see the entry below for *Configure NMEA*. To set Com Port Configuration:

1. Press **MENU | MENU | ↓** to **SYSTEM SETUP | ENT**.
2. Press **↓** to **COMMUNICATIONS PORT | ENT**.

## Configure NMEA

You can configure the unit to use specific NMEA sentences.

1. Press **MENU | MENU | ↓** to **SYSTEM SETUP | ENT**.
2. Press **↓** to **COMMUNICATIONS PORT | ENT | ↓** to **CONFIGURE NMEA | ENT**.
3. A menu appears showing the prefixes of the available NMEA sentences. A check mark next to a prefix means the prefix is in use. Use **↑ ↓ → ←** to select a prefix, then press **ENT** to turn off the prefix. (Press **ENT** again to check the box and turn a prefix on.)

### NOTE:

The names of the NMEA sentences are abbreviated in this menu. These are the functions of the various selectable prefixes:

- GLL transmits latitude and longitude of present position, time of position fix, and status.
- RMC and RMB transmits navigation information messages.
- APB transmits autopilot information.
- GGA transmits time, position, and fix related data.

- GSA and GSV transmits fix mode, DOP values, and satellites in view information.
- DBT transmits the depth below the transducer.
- DPT transmits the depth
- MTW transmits the water temperature.
- VLW transmits the distance traveled through water as measured by the paddle wheel.
- VHW transmits the water speed as measured by the paddle wheel.

4. When the desired prefixes are checked or unchecked, press **EXIT** repeatedly to return to the previous page.

## Coordinate System Selection

The Coordinate System Menu lets you select the coordinate system to use when displaying and entering position coordinates.

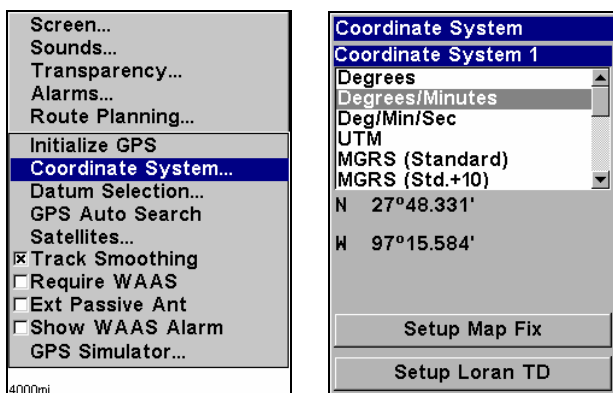

**Menus for changing coordinate system used to display positions.**

To get to Coordinate System Selection:

1. Press **MENU | MENU | ↓** to **GPS SETUP | ENT**.
2. Press **↓** to **COORDINATE SYSTEM | ENT**.

This unit can show a position in degrees (36.14952°); degrees, minutes and thousandths of a minute (36° 28.700'); or degrees, minutes, seconds and tenths of a second (36° 28' 40.9"). It can also show position in: UTM (Universal Transverse Mercator) projection; MGRS (Standard); MGRS (Standard + 10); Map Fix; Loran TD; British, Irish, Finnish, German, New Zealand, Swedish, Swiss, Taiwan and Greek grid systems.

UTM's are marked on USGS topographic charts. This system divides the Earth into 60 zones, each 6 degrees wide in longitude.

British, Irish, Finnish, German, New Zealand, Swedish, Swiss, Taiwan, and Greek grid systems are the national coordinate system used only in their respective countries. In order to use these grid systems, you must be in the respective country. This unit will pick the matching datum for you when you select the grid. See the entry on Map Datum Selection for more information.

The Military Grid Reference System (MGRS) uses two grid lettering schemes, which are referred to as standard and standard + 10 MGRS on this unit. Your position and datum in use determines which one to use. If you use standard, and your position is off significantly, then try the alternate.

**NOTE:** When the position format is changed, it affects the way all positions are shown on all screens. This includes waypoints.

To change the coordinate system, press **ENT** while **COORDINATE SYSTEM** is highlighted. Press **↑** or **↓** to highlight the desired format. Press **ENT** to select it. Press **EXIT** to erase the menus.

**To setup Loran TD:**

**NOTE:**

If the Loran TD conversion is chosen, you must enter the local Loran chain identification for the master and slaves. Do this by selecting "Setup Loran TD" at the bottom of the "Coordinate System" menu and select the ID. Press **EXIT** to erase this menu.

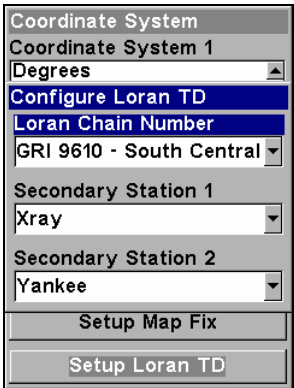

Configure Loran TD menu.

## Customize Page Displays

Every Page display option except Full Map (on the Map Page) has customizable data boxes to provide constant on-screen information.

The various data available from your unit are divided into categories in the Data Viewer menu. These categories include GPS Data, Navigation, Trip Calculator and Time. You can select items from any of these categories for display in any data box — the category divisions are only there to help you sort through the information.

### To change the information displayed in a data box:

On the Page display you wish to change, press **MENU** | ↓ to **CUSTOMIZE** | **ENT**. A data box name flashes, indicating it is selected. Press **ENT** to change the box or hit ↑, ↓, → or ← to select another box, then press **ENT**. You'll see a list of categories with "+" or "-" symbols next to each category. A category with a "+" is *expandable*, meaning its contents are currently hidden.

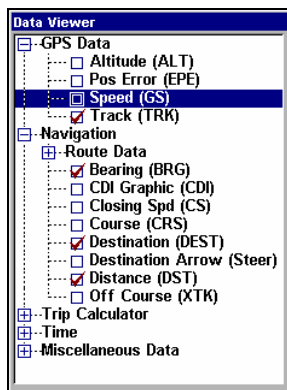

### Customize Menu, with "GPS Data" and "Navigation" categories expanded.

Selecting the category name and pressing **ENT** will show the category's contents, so you can choose items within it. An expanded category (one with a "-" next to its name) can be collapsed to hide its contents. Just select the category name and press **ENT**.

Expand any categories that might contain data you want to display. Then press ↓ or ↑ to select a different data option. With the new option highlighted, press **ENT** to switch the contents of the box to the new data type, then press **EXIT**. You can now select another box to change. When you are finished with the settings, press **EXIT** again to end the Customize command, and the box name stops flashing.

A Page display can show a limited number of data boxes. You can not turn them off or add more data boxes.

# GPS Simulator

The GPS simulator lets you use the unit as if you were outdoors navigating somewhere. It's a great way to practice using your unit. You can set the starting location by entering latitude/longitude (Starting Position) or from a stored waypoint, map place or POI location (**CHOOSE START** command). You can steer your position and change speed on the map by using the arrow keys (**STEER WITH ARROWS** command) or by setting the track and speed in the dialog boxes provided on the simulator menu screen.

## To get to the GPS Simulator:

1. Press **MENU | MENU**, highlight **SYSTEM SETUP** and press **ENT**.
2. Highlight **SIMULATORS** and press **ENT**. The GPS Simulator Menu appears.

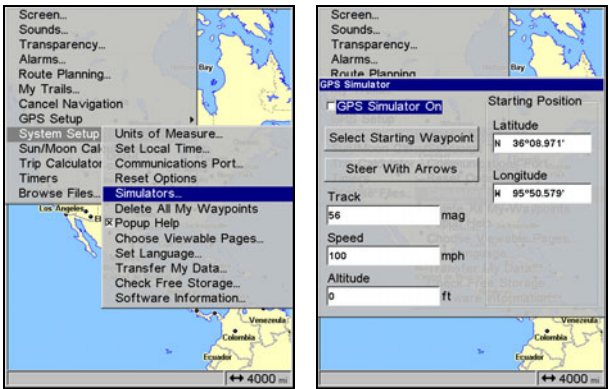

Simulators highlighted on System Setup menu (left). GPS Simulator on selected on Simulators menu (right).

3. Highlight **GPS SIMULATOR ON** and press **ENT** to turn on (check) or turn off (uncheck) the GPS Simulator. Press **EXIT** repeatedly to return to the map display.

## Simulating Trail or Route Navigation

In Simulator mode, your unit can automatically follow a trail or route without manual steering if you use these steps:

1. From the Map Page, go to the simulator menu. Pick a **STARTING POSITION** at or near the beginning of your trail/route. Enter an approximate **TRACK** (shown in compass degrees) that will point you toward the start of the trail/route.
2. Set **SPEED** to zero. Select **STEER WITH ARROWS** command and press **ENT**, which turns on the simulator and returns you to the Map Page.

3. Begin navigating along the trail/route. (If you are close enough to the first waypoint, the arrival alarm will usually go off as soon as navigation begins. Press **EXIT** to clear the alarm.) When navigation starts, press **↑** to increase speed to the desired setting.

4. Press **EXIT** to turn off the steering and speed boxes. The unit will now automatically "steer" along the trail or route. When you arrive at your "destination," cancel navigation as you normally do.

**Tip:**

You can pick any spot on the map to begin your simulation session by using the Initialize GPS command. This makes your unit think it's located at the position you select. See its entry following the entry for *Hide GPS Features*.

## Initialize GPS

This command is handy when you are practicing in simulator mode. (See the entry in this section for *GPS Simulator*.) In simulator mode, this command makes the unit operate as if it is sitting someplace other than its actual location. So, you and your unit could be located in Kansas City, but easily practice navigating in the ocean off Islamorada, Florida.

1. Press **MENU | MENU | ↓** to **GPS SETUP | ENT | ENT**.
2. A message appears, telling you to move the cursor near the desired location and press **ENT**. When the message automatically clears, follow the message instructions.
3. In a moment, your present position marker arrow appears on the map in the location you selected with the cursor. The unit will consider that spot as its last known position until changed by either a live satellite lock-on or a new simulator location.

## Map Auto Zoom

This receiver has an auto zoom feature that eliminates much of the button pushing that other brands of GPS receivers force you to make. It works in conjunction with the navigation features.

First, start navigation to a waypoint. (See the waypoint section for more information on navigating to a waypoint.) Then, with the auto zoom mode on, the unit zooms out until the entire course shows, from the present position to the destination waypoint. As you travel toward the destination, the unit automatically begins zooming in — one zoom range at a time — always keeping the destination on the screen.

To turn this feature on, from the **MAP PAGE**, press **MENU | ↓** to **AUTO ZOOM | ENT | EXIT**. Repeat these steps to turn it off.

# Map Data

This menu lets you turn the map off, if desired (which turns the map screen into a GPS plotter); turn off or on the pop-up map info boxes; draw the map boundaries or boxes around the areas of high detail; or fill land areas with gray. You can also turn on or off Map Overlays, which display latitude and longitude grid lines or range rings on the map. This menu lets you select Navionics Maps; for instructions, see the *Navionics Charts* entry in this section.

To get to Map Data:

From the Map Page, press **MENU** | ↓ to **MAP DATA** | **ENT**.

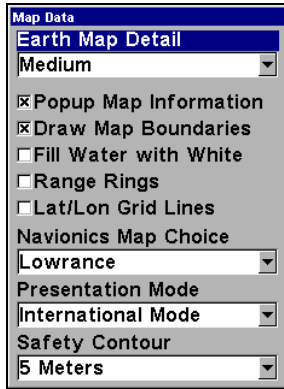

Map Data Menu

## Show Map Data

From the Map Page, press **MENU** | ↓ to **MAP DATA** | **ENT**. Press **ENT** to enter the **EARTH MAP DETAIL** selection list, and choose how much detail you want, from Off (so the unit operates like a GPS plotter) to High. After the option is set, press **EXIT** repeatedly to return to the page display.

## Pop-up Map Information

From the Map Page, press **MENU** | ↓ to **MAP DATA** | **ENT**. Press ↓ to **POPUP MAP INFORMATION**. With the option highlighted, press **ENT** to check it (turn on) and uncheck it (turn off.) After the option is set, press **EXIT** | **EXIT** to return to the page display.

## Map Boundaries

From the Map Page, press **MENU** | ↓ to **MAP DATA** | **ENT**. Press ↓ to **DRAW MAP BOUNDARIES**. With the option highlighted, press **ENT** to check it (turn on) and uncheck it (turn off.) After the option is set, press **EXIT** | **EXIT** to return to the page display.

### Fill Water With White

From the Map Page, press **MENU**|↓ to **MAP DATA**|**ENT**. Press ↓ to **FILL WATER WITH WHITE**. With the option highlighted, press **ENT** to check it (turn on) and uncheck it (turn off.) After the option is set, press **EXIT**|**EXIT** to return to the page display.

### Map Overlays (Range Rings; Lat/Long Grid)

The map screen can be customized with four range rings and/or grids that divide the plotter into equal segments of latitude and longitude.

Range rings are handy for visually estimating distances on the map. The ring diameters are based on the current zoom range. For example: at the 100 mile zoom, the screen will show two rings with your current position in the center. The large ring touching the left and right sides of the screen is 100 miles in diameter (same as the zoom range). The second smaller ring is 50 miles in diameter (always 1/2 the zoom range).

The distance from your current position to the smaller ring (the ring's radius) is 25 miles (always 1/4 the zoom range). With the arrow keys and map cursor, you can scroll the map to see the third and fourth rings. In this example, the distance to the third ring is 75 miles and distance to the fourth ring is 100 miles from your current position.

**To set range rings:** From the Map Page, press **MENU**|↓ to **MAP DATA**|**ENT**. Press ↓ to **RANGE RINGS**. With the option highlighted, press **ENT** to check it (turn on) and uncheck it (turn off.) After the option is set, press **EXIT**|**EXIT** to return to the page display.

**To set Lat/Long Grid:** From the Map Page, press **MENU**|↓ to **MAP DATA**|**ENT**. Press ↓ to **LAT/LON GRID LINES**. With the option highlighted, press **ENT** to check it (turn on) and uncheck it (turn off.) After the option is set, press **EXIT**|**EXIT** to return to the page display.

### Map Datum Selection

Maps and charts are based on a survey of the area that's covered by the map or chart. These surveys are called "Datums." Maps that are created using different datums will show the same latitude/longitude in slightly different locations.

All datums are named. The GPS system is based on the WGS-84 datum, which covers the entire world. Other datums may also cover the entire world, or just a small portion of it. By default, your position shows using the WGS-84 datum. However, it can show your position using one of 191 different datums.



Different datums can be selected; to change the datum:

1. Press **MENU** | **MENU** | ↓ to **GPS SETUP** | **ENT** | ↓ to **DATUM SELECTION** | **ENT**.
2. Scroll ↓ or ↑ to select the desired datum, then press **ENT**.
3. To return to the last page displayed, press **EXIT** | **EXIT**.

A list of the datums used by this unit is in the back of this manual.

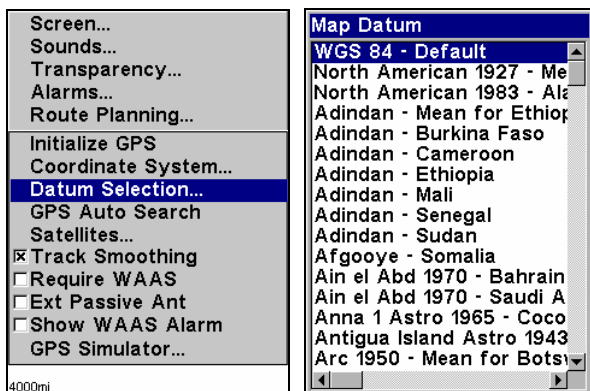

GPS Setup Menu, left, Map Datum Menu, right.

## Map Detail Category Selection

This menu determines which of the mapping features are shown on the screen. This includes, waypoints, trails, icons, cities, highways, etc. You can selectively turn on or off any of these items, customizing the map to your needs.

To get to Map Categories:

1. From the Map Page, press **MENU** | ↓ to **MAP CATEGORIES DRAWN** | **ENT**.
2. Press ↑ or ↓ to select a category or press → or ← to select a subcategory. Press **ENT** to turn it off (no check) or on (checked.)
3. To return to the last page displayed, press **EXIT** | **EXIT**.

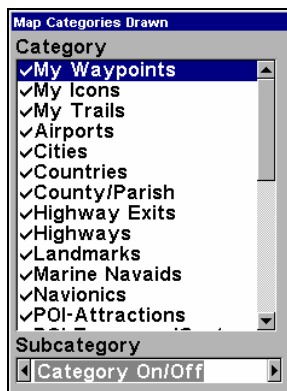

Map Categories Drawn Menu.

## Map Fix

Map Fix is used with charts or maps. This system asks for a reference position in latitude/longitude, which you take from a marked location on the map. It then shows the present position as distance on the map from that reference point.

For example, if it shows a distance of UP 4.00" and LEFT 0.50", you then measure up three inches and to the left a half-inch from the reference point on the map to find your location.

### To configure a map fix:

To use this format, you need to follow these steps in order. First, take your map of the area and determine a reference latitude/longitude. (Note: in order for this system to work, the latitude/longitude lines must be parallel with the edge of the map. USGS maps are parallel, others may not be. Also, this works better with smaller scale maps, such as 1:24000.) The reference position can be anywhere on the map, but the closer it is to your location, the smaller the numbers will be that you'll have to deal with.

Once you've decided on a reference position, you can save it as a waypoint. See the waypoint section for information on saving a waypoint. Save the reference position as a waypoint. Exit from the waypoint screens.

1. Press **MENU | MENU | ↓** to **GPS SETUP | ENT**.
2. Press **↓** to **COORDINATE SYSTEM | ENT**.
3. Press **↓** to **SETUP MAP FIX | ENT**.

The screen below appears, and **MAP SCALE** is highlighted. Press **ENT** and enter the map's scale. This is generally at the bottom of the paper map. It's shown as a ratio, for example 1:24000. Press **EXIT** and the unit returns to the Configure Map Fix screen.

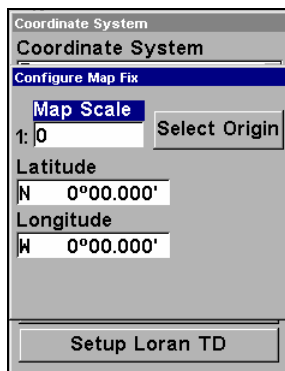

**Configure a map fix so the unit can find your position on a printed chart or topographical map.**

Press → to **SELECT ORIGIN | ENT | ENT | ENT** to bring up the waypoint list. Select the waypoint (or a landmark of a POI) that you saved the reference point under and press **ENT**. The unit displays a waypoint information screen with the command **SET AS ORIGIN** selected; press **ENT** and the unit returns to the Configure Map Fix menu. Finally, press **EXIT** to erase this menu. Now press ↑ to **COORD SYSTEM | ENT**, select **MAP FIX** from the list and press **ENT | EXIT**. All position information now shows as a distance from the reference point you chose.

## Map Orientation

By default, this receiver shows the map with north always at the top of the screen. This is the way most maps and charts are printed on paper.

**In Track Up mode, map shows "N" and arrow to indicate north.**

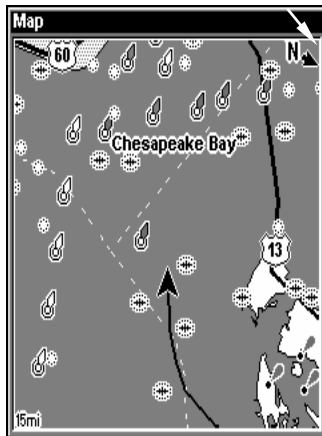
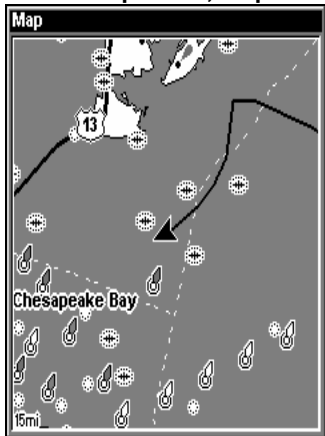

**Map orientation set to north up (left). Orientation set to track up (right).**

This is fine if you're always traveling due north. What you see to your left corresponds to the left side of the map, to your right is shown on the right side of the map, and so on. However, if you travel any other direction, the map doesn't line up with your view of the world.

To correct this problem, a track-up mode rotates the map as you turn. Thus, what you see on the left side of the screen should always be to your left, and so on.

Another option is course-up mode, which keeps the map at the same orientation as the initial bearing to the waypoint. When either the track-up or course-up mode is on, an "N" shows on the map screen to help you see which direction is north.

To change map orientation: from the Map Page, press **MENU** |  $\downarrow$  to **MAP ORIENTATION** | **ENT**. Use  $\uparrow$  or  $\downarrow$  to select the desired mode, then press **ENT**. Press **EXIT** | **EXIT** to return to the page display.

**NOTE:**

In North Up and Course Up, the present position arrow appears in the center of the map page. In Track Up, the position arrow appears centered in the lower third of the page.

### NauticPath™ USA Marine Charts

Your unit can display NauticPath electronic charts on MMCs. They work just like a MapCreate custom map on a MMC.

#### Nautical Chart Notes

NauticPath charts contain notes or chart information, represented by circle-i Chart Note icons on the map display. An example is shown in the following figure.

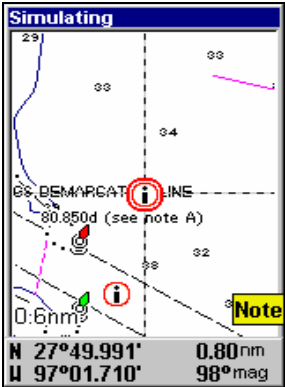

NauticPath chart showing Chart Note icon selected by cursor (left).

### To view Chart Note information:

1. Use the arrow keys to move the cursor over a Chart Note icon. When it's selected, a pop-up name box appears.
2. Press **WPT** to display the Note Information screen.
3. To scroll through the Chart Note screen, use  $\uparrow$   $\downarrow$  arrow keys to read the information. To return to the main page display, press **EXIT** repeatedly.

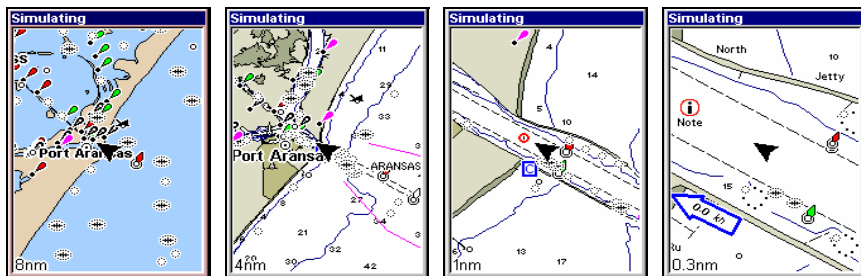

Entrance to Aransas Pass on a NauticPath chart with 8-nautical mile zoom (left). Remaining images (left to right): same position at 4-nautical mile, 1-nautical mile and 0.3- nautical mile zoom ranges.

### Port Information

NauticPath charts contain Port Services information, represented by anchor icons on the map display. These icons will appear when you are zoomed in to a 4-nautical mile range. An example is displayed in the following figures.

### To view Port Services information:

1. Use the arrow keys to move the cursor over a Port Services icon. When it is selected, a pop-up name box appears.
2. Press **WPT** to display the Port Services Information screen. The Port Services information screen for a NauticPath chart contains all the service information in one window.
3. To scroll through the service information window, use  $\uparrow$   $\downarrow$  to see the types of services available. To return to the main page display, press **EXIT** repeatedly.

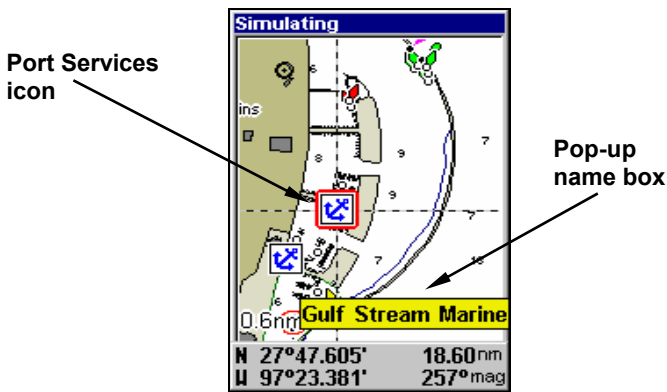

NauticPath chart showing Port Services icon selected by cursor. When first highlighted, the Pop-Up name box appears.

### Tidal Current Information

NauticPath charts contain Tidal Current information, represented at large zoom ranges by a box icon with the letter "C." These icons will appear when you are zoomed in to a 6-mile range. The icon stands for a Tidal Current Station location. An example is displayed on the right.



When you zoom in to a sufficiently small zoom range (0.8 nautical mile), the icon becomes an animated arrow showing tidal current velocity and direction *for the selected tidal station* at the present time.

At larger zoom ranges, you can select the boxed "C" icon and it becomes an animated arrow with a pop-up name box (the name box disappears after a few seconds). Examples are displayed in the following figures.

#### To view Tidal Current information:

1. Use the arrow keys to move the cursor over a Tidal Current Station icon. When it is selected, a pop-up name box appears.
2. Press **WPT** to display the Tidal Current Information screen.

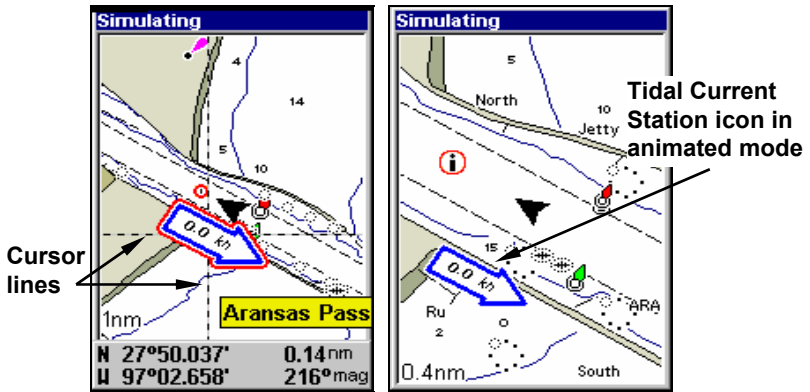

NauticPath chart showing Tidal Current Station icon selected by cursor (left). Icon animates automatically at .08-mile zoom range (right).

**Current Time Line**

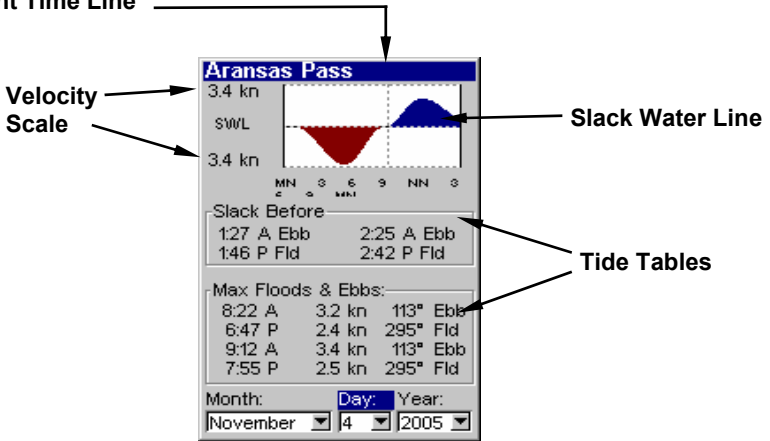

**Current Information screen.**

The Tidal Current Information screen displays daily tidal current data for this station on this date at the present time. The graph at the top of the screen is an approximate view of the flood and ebb pattern for the day, from midnight (MN), to noon (NN) to midnight (MN). The velocity scale at the top left side of the graph changes dynamically based upon the maximum velocity of the current for that day.

Slack water, the period of little or no current, is represented by the Slack Water Line (SWL). The flood appears above the SWL and the ebb appears below the SWL. You can look up tidal current data for other dates by changing the month, day and year selection boxes.

**To select another date:**

- 1. Use ← → to highlight month, day or year, then press **ENT**.
- 2. Use ↑ ↓ to select the desired month, day or year and press **ENT**.

To clear the information screen, press **EXIT**.

**Tide Information**

NauticPath charts contain Tidal Information, represented at large zoom ranges by a box icon with the letter "T." These icons will appear when you are zoomed in to a 6-mile range. The icon stands for a Tidal Station location. An example is displayed at right.

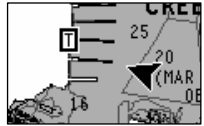

When you zoom in to a sufficiently small zoom range (0.8 nautical mile), the icon becomes an animated gauge showing a rising or falling tidal height *for the selected station* at the present time. At larger zoom ranges, you can select the boxed "T" icon and it becomes an animated gauge with a pop-up name box. The name box disappears seconds.

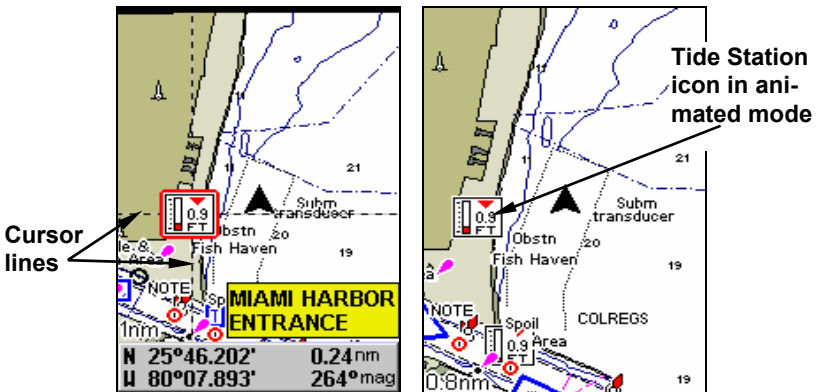

NauticPath chart showing Tide Station icon selected by cursor (left). Icon animates automatically without selection at the 0.8-mile zoom range (right). In the example above, the tide is at 0.9 feet and falling, as shown by the down arrow at the top of the icon.

**To view tide information:**

- 1. Use the arrow keys to move the cursor over a tide station icon. When it is selected, a pop-up name box appears.
- 2. Press **WPT** to display the Tide Information screen.



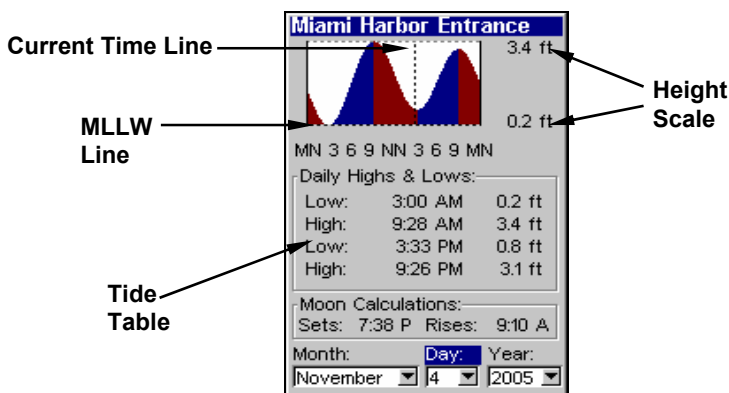

**Tide Information screen.**

The Tide Information screen displays daily tidal data for this station on this date at the present time. The graph at the top of the screen is an approximate view of the tidal range pattern for the day, from midnight (MN) to noon (NN) to midnight (MN). The dotted line across the graph is the Mean Lower Low Water line (MLLW).

The height scale on the top right side of the graph changes, based upon the maximum *range* of the tide for that day. The MLLW line also adjusts its position as the height scale changes.

You can look up tidal data for other dates by changing the month, day and year selection boxes. To select another date:

1. Use ← → to highlight month, day or year, then press **ENT**.
2. Use ↑ ↓ to select the desired month, day or year and press **ENT**.

To clear the information screen, press **EXIT**.

## Navionics® Charts

Your unit can also display Navionics electronic charts on MMCs. Like NauticPath, Navionics charts contain tide and port service information.

### NOTE:

The primary operational difference between a NauticPath chart and a Navionics chart is the way the chart data is set up for display. NauticPath charts are ready for display as soon as they are inserted into the unit. Navionics charts must be inserted into the unit, then selected as a Map Choice option in the Map Data menu.

### To display a Navionics chart:

1. Install the Navionics MMC in the memory card compartment and turn on the unit. (For full card install instructions, see Sec. 2.)

2. From the Map Page, press **MENU**|↓ to **MAP DATA**|**ENT**|↓ to **MAP CHOICE**|**ENT**. Select the *Map Name*, then press **ENT**|**EXIT**|**EXIT**.

**WARNING:**

**You should never format the MMC containing your Navionics chart. Formatting the MMC will permanently erase the chart from the card.**

## Overlay Data

On any Page display but Status you can float additional data of your own choosing in your display window. For example, if you left your watch at home, you could add the local time to your display. Or, if you wanted to see details about your route and trip, you could show your bearing, course, average speed and trip distance. The data could be customized to

The various data available from your unit are divided into categories in the Overlay Data menu. These categories include GPS Data, Navigation, Trip Calculator and Time.

You can select items from any of these categories for display, in any combination — the category divisions are there only to help you sort through the information.

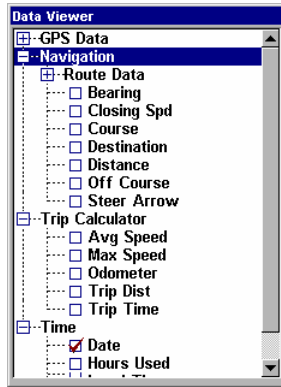

**Overlay Data with Navigation, Trip Calculator and Time categories expanded.**

### To overlay information on your screen:

1. While on the Navigation Page or a Map Page, press **MENU**|↓ to **OVERLAY DATA**|**ENT**.
2. You'll see a list of the overlay data currently shown, if any. Select **(ENTER TO ADD)** and press **ENT**. The data viewer shows information categories with "+" or "-" symbols next to each category name.

A category with a "+" next to it is *expandable*, meaning its contents are currently hidden.

Selecting the category name and pressing **ENT** will show the category's contents, so you can choose items within it. An expanded category (one with a "-" next to its name) can be collapsed to hide its contents, and make more room on your screen. Just select the category name and press **ENT**.

3. Expand any categories that might contain information you want to display. Then press **↓** or **↑** to select a display option.

4. With the option highlighted, press **ENT** to check it (turn on) and uncheck it (turn off). As you turn categories on, data will float in your display window. Every Page display has a maximum number of items you can float on your display using the Overlay Data command.

5. After all options are set, press **EXIT | EXIT** to return to the page display.

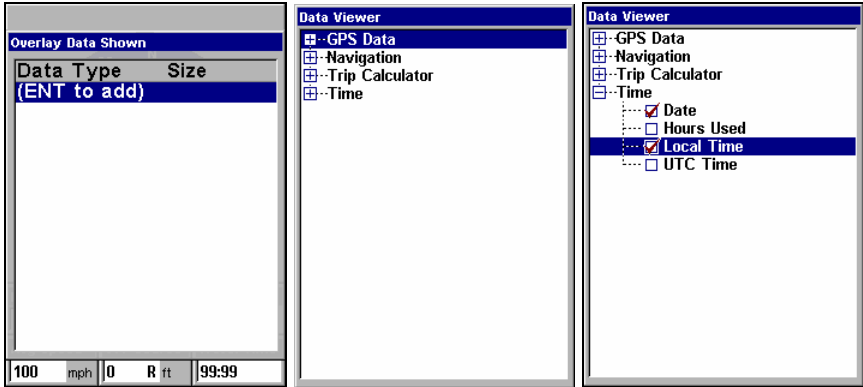

From Overlay Data Shown (left) press **ENT** to see Data Viewer (center). Select a category and press **ENT**; then select information to float on screen and press **ENT** (right).

**To remove overlaid data:**

1. While on the Page that shows the item or items you want to remove, press **MENU | ↓** to **OVERLAY DATA | ENT**.

2. You'll see a list of the overlay data currently displayed. Select the item you want to remove from your display and press **ENT | ENT** to remove the data. To remove another item, select the item and press **ENT | ENT**.

3. When you have finished removing all the items you want from the screen, press **EXIT** to return to the page display.

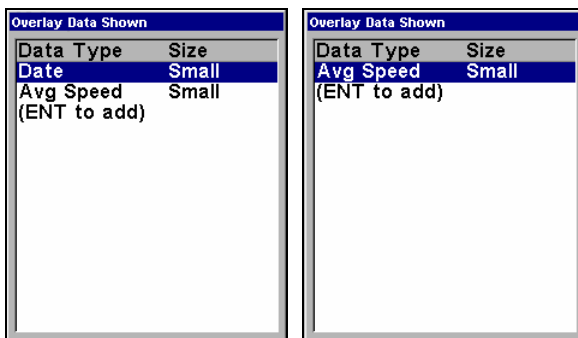

**Overlay Data Shown, with Date option selected (left). Overlay Data Shown menu with Date Removed from the list (right).**

### To move overlaid data:

You may find it useful to rearrange data that is floating in your display window.

1. From one of the Map Pages, press **MENU | ↓** to **OVERLAY DATA | ENT**.
2. You'll see a list of the overlay data currently displayed. Select the item you want to move and press **ENT | →** to **MOVE | ENT**.
3. The data begins to flash on your screen. Use any combination of **→**, **←**, **↑** and **↓** to move the data to a new location on the screen.
4. When satisfied, press **EXIT | EXIT**.

### NOTE:

The Customize command and the Overlay Data command both use the same information categories. The difference between the two commands is that Customize changes only the data boxes on your display, and Overlay Data floats information anywhere on the screen. See Customize Page Displays, on page 78, for information on customizing data boxes.

## Pop-up Help

Help is available for virtually all of the menu labels on this unit. By highlighting a menu item and leaving it highlighted for a few seconds, a "pop-up" message appears that describes the function of the menu item. This feature is on by default.

**To set up Pop-up Help:** Press **MENU | MENU | ↓** to **SYSTEM SETUP | ENT | ↓** to **POPUP HELP**. With the option highlighted, press **ENT** to check it (turn on) and uncheck it (turn off.) After the option is set, press **EXIT | EXIT** to return to the page display.

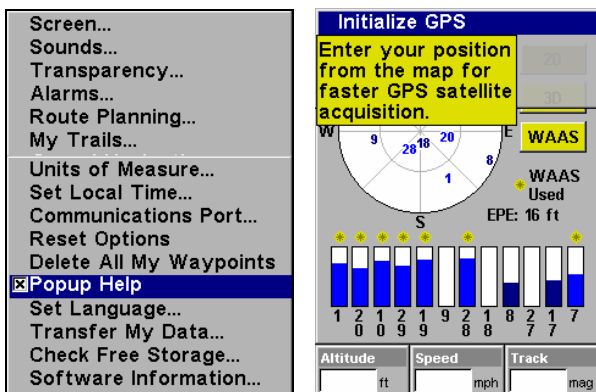

System Setup Menu (left) with Pop-up Help command highlighted. The second example (right) shows the Pop-up Help message for the Initialize GPS command, located on the Status Page menu.

## Reset Options

To reset all features to their factory defaults:

1. Press **MENU | MENU | ↓** to **SYSTEM SETUP | ENT | ↓** to **RESET OPTIONS | ENT | ←** to **YES | ENT**.

### NOTE:

Reset Options does *not* erase any waypoints, routes, icons or plot trails.

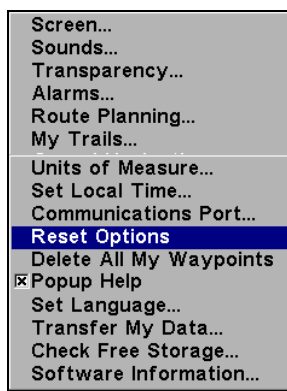

System Menu with Reset Options command selected.

## Require WAAS

You can force the unit to require WAAS for reporting a valid position. (The default setting, off, uses WAAS automatically, but doesn't require it to yield a position.) Here's how to turn it on and off:

1. Press **MENU | MENU | ↓** to **GPS SETUP | ENT | ↓** to **REQUIRE WAAS | ENT**.
2. To return to the last page displayed, press **EXIT | EXIT**.
3. You can return to this command and press **ENT** again to turn the feature off.

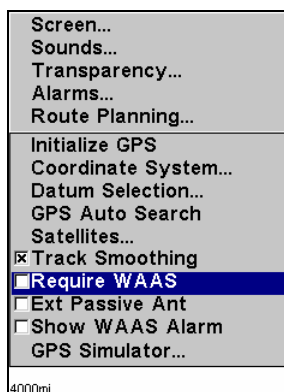

Require WAAS command on the GPS Setup Menu.

## Screen Contrast and Brightness

To access the Screen menu, press **MENU | MENU | ENT**.

The **CONTRAST** slider bar is already selected. Press **→** or **←** to move the bar. The left end of the scale is minimum contrast; the right end is maximum contrast.

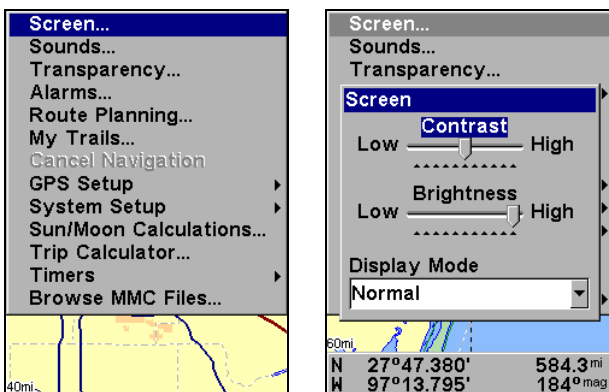

Screen selected on main menu (left). Screen Menu with Contrast bar selected (right).

To adjust the display's brightness:

Press ↓ to **BRIGHTNESS**. Press → or ← to move the bar. The left end of the scale is minimum contrast; the right end is maximum contrast.

To adjust the screen's display mode:

Press ↓ to **DISPLAY MODE** | **ENT** | press ↑ or ↓ to select *mode* | **EXIT**.

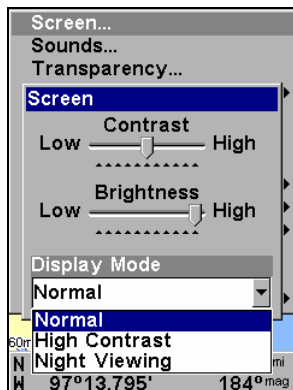

Display Mode menu.

## Set Language

This unit's menus are available in 10 languages: English, French, German, Spanish, Italian, Danish, Swedish, Russian, Dutch and Finnish. To select a different language:

1. Press **MENU** | **MENU** | ↓ to **SYSTEM SETUP** | **ENT**.
2. Press ↓ to **SET LANGUAGE...** | **ENT**.
3. Use ↓ or ↑ to select a different language and press **ENT**. All menus now appear in the language you selected.

## Set Local Time

Using the correct local time setting is handy when estimating local arrival time while navigating. Also, the time and date are saved when a waypoint is created.

To access the Set Local Time menu, you must first acquire your position. Once that is done: press **MENU** | **MENU** | ↓ to **SYSTEM SETUP** | **ENT** | ↓ to **SET LOCAL TIME** | **ENT**.

**To set Local Time:** Press **ENT**. Press ↑ or ↓ to change the first character, then press → to move the cursor to the next character. Repeat until the time is correct, then press **ENT**.

**To set the Month:** Press ↓ to **MONTH**|**ENT**. Press ↑ or ↓ to select the month, then press **ENT**.

**To set the Day:** Press ↓ to **MONTH**|→ to **DAY**|**ENT**. Press ↑ or ↓ to select the day, then press **ENT**.

**To set the Year:** Press ↓ to **MONTH**|→ to **YEAR**|**ENT**. Press ↑ or ↓ to select the year, then press **ENT**.

The last field in this menu is **CONFIG DST**. This feature allows your unit to automatically adjust with the time change caused by Daylight Saving Time (you should only have to set it once). You may select which set of rules matches DST in your region, or simply accept the default.

Once you have each field set the way you want, press **EXIT** repeatedly until you return to the previous page.

## Show WAAS Alarm

When the signal is available, your unit will automatically use WAAS to boost the accuracy of the position fix. When the WAAS signal is lost or acquired, an alarm message appears. Since the U.S. government is still developing the WAAS system, it's not unusual for a GPS/WAAS receiver to frequently lose and reacquire its lock on a WAAS satellite. That can result in the alarm repeatedly going on and off. If you want, you have the option of turning off the WAAS Acquired/Lost alarm without affecting how the unit uses WAAS. Here's how:

1. Press **MENU**|**MENU**|↓ to **GPS SETUP**|**ENT**|↓ to **SHOW WAAS ALARM**.
2. With the option highlighted, press **ENT** to uncheck it (turn off) and check it (turn on.) After the option is set, press **EXIT**|**EXIT** to return to the page display.
3. You can return to this command and press **ENT** again to turn the feature on.

## Software Version Information

From time to time, Lowrance updates the operating system software in some of its products. These software upgrades are usually offered to customers as free downloads from our web site, **www.lowrance.com**. These upgrades make the unit perform better or introduce a new feature or function. You can find out what software version is running in your unit by using the Software Information command.

1. Press **MENU**|**MENU**|↓ to **SYSTEM SETUP**|**ENT**|↓ to **SOFTWARE INFORMATION**|**ENT**.
2. Read the information displayed on the screen.
3. To return to the last page displayed, press **EXIT** repeatedly.



## Sounds and Alarm Sound Styles

Sounds triggered by key strokes and alarms can be adjusted:

You first press **MENU | MENU | ↓** to **SOUNDS | ENT**.

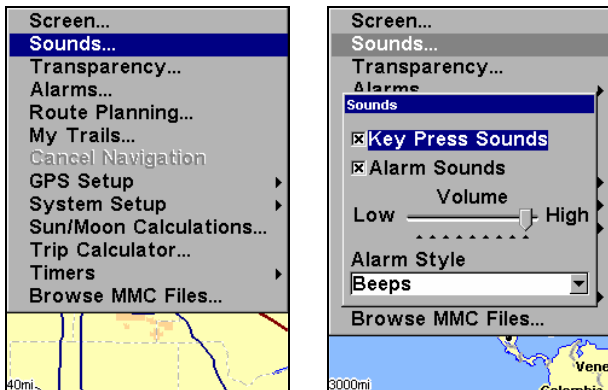

Sounds command (left). The Sounds menu (right).

**To set Key Press Sounds:** With the option highlighted, press **ENT** to check it (turn on) and uncheck it (turn off.) After the option is set, press **EXIT | EXIT** to return to the page display.

**To set Alarm Sounds:** Press **↓** to **ALARM SOUNDS**. With the option highlighted, press **ENT** to check it (turn on) and uncheck it (turn off.) After the option is set, press **EXIT | EXIT** to return to the page display.

**To set Alarm Volume:** Press **↓** to **VOLUME**. Press **→** or **←** to move the bar. The left end of the scale is low volume; the right end is high volume. After the option is set, press **EXIT | EXIT** to return to the page display.

**To set Alarm Style:** Press **↓** to **ALARM STYLE | ENT**. Press **↑** or **↓** to change the style, then press **ENT**. After the option is set, press **EXIT | EXIT** to return to the page display.

## Track Smoothing

This is a factory setting on the GPS Setup menu that *should always be left on*. When stopped or traveling at slow speeds (such as walking or trolling), Track Smoothing prevents wandering of trails, the steering arrow, compass rose and a map in track-up mode.

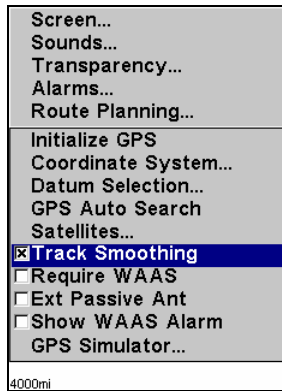

Track Smoothing option, turned on.

## Trail Options

There are several options you can use with trails. Some affect all trails, other options can be applied to a particular trail. You can change the way trails are updated, display or hide trails, create a new trail, delete a trail, etc.

### General Trail Options

To access the Trails Menu:

1. Press **MENU | MENU | ↓** to **MY TRAILS | ENT**.

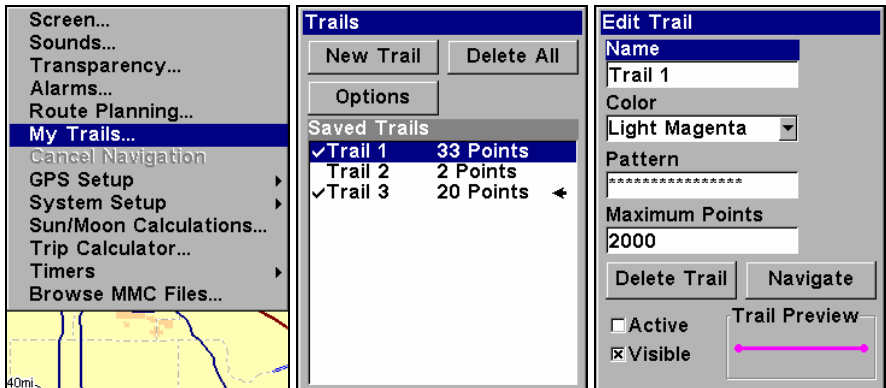

Main Menu (left). Trails Menu (center). Trail Options (right).

### Delete All Trails

To remove all of the trails from memory: from the Trails Menu, press → to **DELETE ALL | ENT | ←** to **Yes | ENT**.

## Update Trail Option

This menu lets you change the way the trail updates occur.

### WARNING:

If you *uncheck* the Update Trail option, automatic trail creation and recording will be turned off. You must turn it back on to record trails. The default setting is on.

From the Trails Menu, press ↓ to **OPTIONS|ENT**. With **UPDATE ACTIVE TRAIL** highlighted, press **ENT** to check it (turn on) and uncheck it (turn off).

The options are automatic, time, or distance. When it's in the default automatic mode, the unit doesn't update the plot trail while you're traveling in a straight line. Once you deviate from a straight line, the unit "drops" a plot point (trail waypoint) onto the trail. This conserves plot trail points. If a plot trail uses all of the available points allotted to it, the beginning points are taken away and placed at the end of the trail.

From the Trails Menu, press ↓ to **OPTIONS|ENT|↓** to **UPDATE CRITERIA**. Press ← or → to select *criteria type* | **ENT**.

You can update a trail by time, with a range from 1 second to 9999 seconds; the default is 3 seconds. You can update by distance, with a range from 0.01 mile/nm/km to 9.99 mile/nm/km; the default is 0.10 mi.

With one of the Update Criteria selected, use the cursor arrows to highlight either the **UPDATE RATE** or **UPDATE DISTANCE** data entry boxes and press **ENT**. Press ↑ or ↓ to change the first character, then press → to the next character and repeat until the entry is correct. Press **EXIT** to return to the Trail Options Menu.

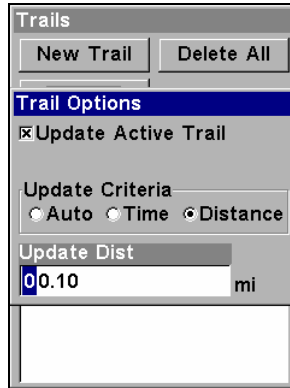
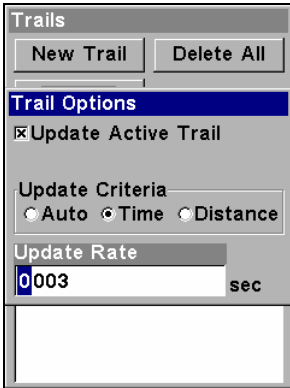

Update Time Rate setting (left). Update Distance setting (right).

## Specific Trail Options

### Delete Trail

To delete a specific trail: From the Trails Menu, press ↓ to *Trail Name* | **ENT**. The Edit Trail menu appears as seen in the following figure. Press ↓ to **DELETE TRAIL** | **ENT** | ← to **YES** | **ENT**.

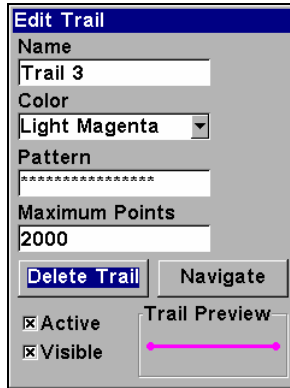

Edit Trail menu.

### New Trail

To manually start a new trail, in the Trails Menu, make sure **NEW TRAIL** is highlighted and press **ENT**.

### Trail Visible/Invisible and Other Trail Options

The name, maximum number of points in the trail, activity, and visibility are all changed on the Edit Trail menu screen. The Active setting determines whether or not the unit is recording new points for a particular trail.

On the Edit Trail menu, press ↓ or ↑ to highlight the section you wish to change, then press **ENT**. Make your changes, then press **EXIT** to erase this menu. Related trail functions are discussed in further detail under the Trails topic in Sec. 4, *Advanced GPS Operations*.

### Transparency

Use the transparency menu to adjust the transparency of menu windows. A high transparency allows you to continue monitoring the screen's display while adjusting feature settings, though the text of the menus may fade until it is unreadable. A low transparency will usually make menu text easier to read, at the cost of watching your display.

Experiment with this feature until you find the right level of transparency for your eyes.

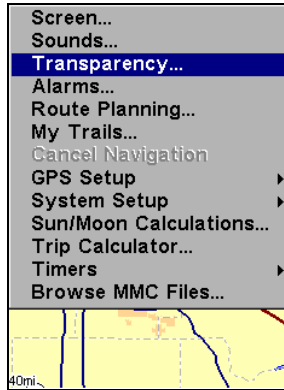

Main Menu with Transparency selected.

### To adjust Menu Transparency level:

Press **MENU | MENU | ↓** to **TRANSPARENCY | ENT**. The **TRANSPARENCY** slider bar appears. Press **↑** or **↓** to move the bar. The lower end of the scale makes the menus opaque; the upper end is maximum transparency.

### Units of Measure

This menu sets the speed and distance (statute or nautical miles, meters), depth (feet, fathoms, or meters), temperature (degrees Fahrenheit or Celsius), altitude (feet or meters) and heading (true or magnetic) units. To change the units:

Press **MENU | MENU | ↓** to **SYSTEM SETUP | ENT | ENT**.

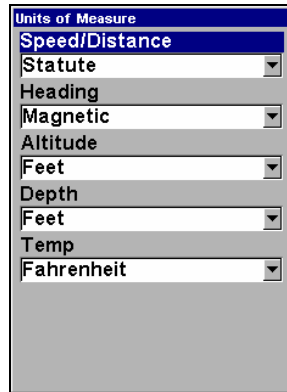
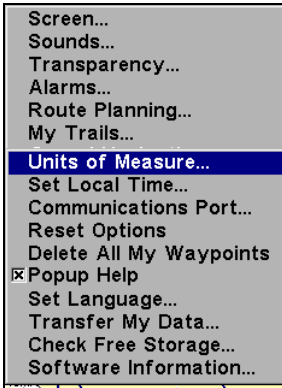

Units of Measure highlighted on main menu (left). Units of Measure menu (right).

**To set Unit of Measure:** Use **↑ ↓** to select the desired category and press **ENT**. Use **↑ ↓** to select the desired unit of measure and press **ENT**. If you wish, you can now pick another category to change. After the option is set, press **EXIT** repeatedly to return to the page display.

# Notes

# Section 6: Searching

## NOTE:

The background map loaded in your unit lets you to search for U.S. Interstate Highway exits and exit services, as well as some land features, including cities and lakes. For a full set of searchable land features, including landmarks, streets, addresses and Points of Interest, you must load your own high-detail custom map produced with our Mapcreate software. For a complete description of what detail is found in the background map and custom MapCreate maps, see page 33. (Remember, our pre-made FreedomMaps contain all the same detail found in custom-made MapCreate maps.)

This unit's varied search functions all begin with either the Find Waypoint menu or the Map Page menu. Press **WPT** and the Find Waypoint menu appears for waypoints and Points of Interest (POI). From the Map Page, press **MENU** and the Map Page menu appears for streets, addresses and highway exits.

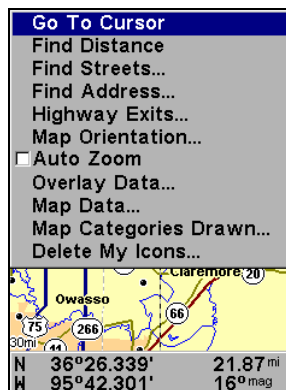
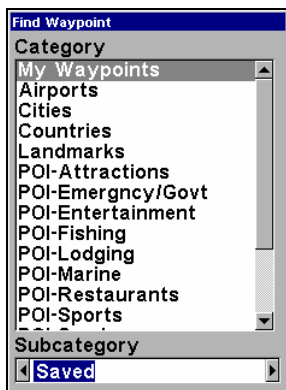

Find Waypoint menu (left). Map Page menu (right).

## IMPORTANT NOTES:

Our search commands let you look up items by name, or search for the item nearest to you. When you search, the unit looks for items in the vicinity of your current position. If you are using the unit indoors, in simulator mode or otherwise haven't locked on to satellites, the unit looks near the last known position.

To search in some other location, use the arrow keys to center the map cursor where you want to look. When the cursor is active, the unit always begins searching at the cursor location.

In search results, the distance and bearing to the selected item will be calculated from the current position. In the case of a cursor search, the search results show distance and bearing from the cursor, but an individual waypoint's information screen shows distance and bearing from the current (or last known) position.

## Find Addresses

1. From the Map Page, press **MENU** | ↓ to **FIND ADDRESS** | **ENT**.
2. Press **ENT** to search in the Address field.
3. **To enter an address number**, press ↑ or ↓ to change the first number, then press → to move the cursor to the next number and repeat until the number is correct, then press **ENT**.

Go To Cursor		
Find Distance		
Find Streets...		
Find Address		
Address		
0		
Street		
None		
City		
Any		
Find Address		
40mi		
N	36°09.269'	0.38 mi
W	95°50.764'	329° mag

Find Address Menu.

4. **To enter a street name**, press ↓ to **STREET** | **ENT**. There are two options: **A.** You can **spell out** the name in the top selection box. Press ↑ or ↓ to change the first letter, then press → to move the cursor to the next letter and repeat until the name is correct, then press **ENT** | **ENT**. **B.** Jump down to the lower selection list by pressing **ENT**, then press ↓ or ↑ to select a street name from the list, then press **ENT**. The street name you selected is now in the street field.



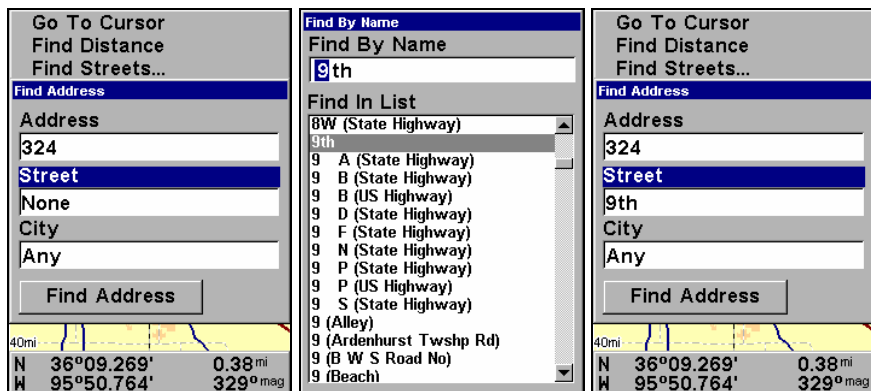

Find Address menu (left). Find Street menu (center) with Find By Name field active. Street name entry complete (right).

5. To enter a city name, press  $\downarrow$  to **CITY** | **ENT**. You will be asked if you want to find addresses only within a particular city. This option is designed so you can limit an address search to a single city if necessary (see the following note).

If you select yes, there are two options: **A.** You can **spell out** the city name in the top selection box. Press  $\uparrow$  or  $\downarrow$  to change the first letter, then press  $\rightarrow$  to move the cursor to the next letter and repeat until the name is correct, then press **ENT** | **ENT**. **B.** Jump down to the lower selection list by pressing **ENT**, then press  $\downarrow$  or  $\uparrow$  to select a city name from the list, then press **ENT**. The city name you selected is now in the city field.

**NOTE:**

We recommend that you do *not* enter a city name unless the list you are given is too large when searching without it. This unit can actually search quicker without a city and you save time by not entering a city name.

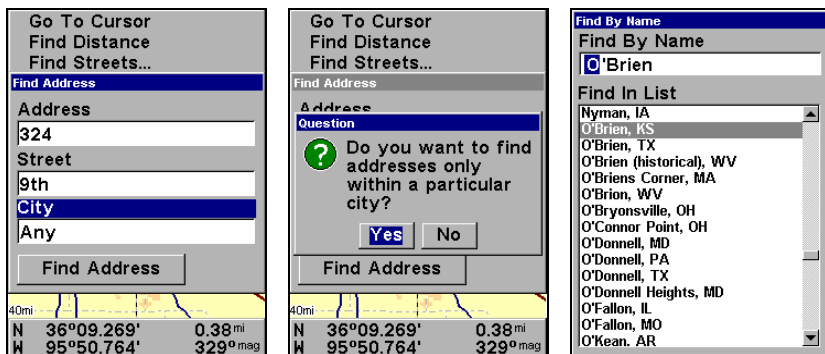

Find City field (left). Search in particular city only option (center). Find City by name (right).

6. When the necessary search fields are filled in, press  $\downarrow$  to **FIND ADDRESS|ENT**. Your unit asks you to wait while it searches for the address. (If an address is not in the database, a message appears saying the address could not be found.)

7. The unit will display a list of addresses. If the address you are looking for is highlighted at the top of the list, press **ENT**. If not, use  $\downarrow$  and  $\uparrow$  to select the correct address from the list, then press **ENT**. The Map Page will then appear with the location selected by the cursor. (In the following example, we are looking for 12303 East 11th Street in Tulsa, not 11th Court, so we had to scroll down the list to select the right one.)

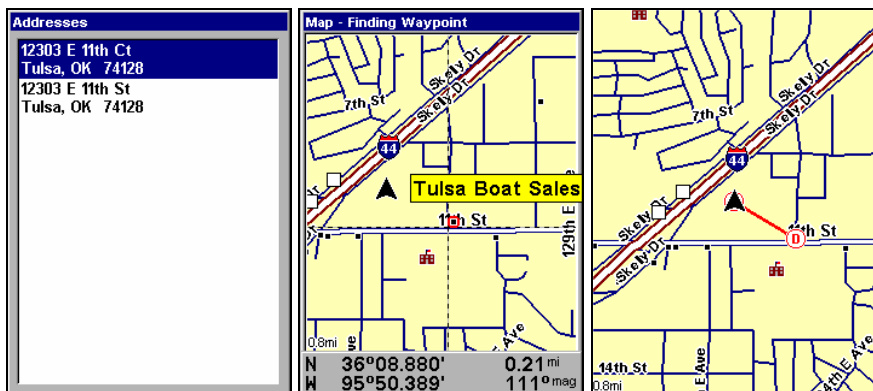

**Address search result list (left). Map Page showing location of the address on the map (center) highlighted by cursor. After the address is located, you can navigate to it ("D" symbol for destination) (right).**

8. To navigate to the address, press **MENU|ENT|EXIT** and the unit will begin showing navigation information to the address pointed out by the cursor. If you are only looking up an address (not navigating), just press **EXIT** to return to the previous page.

### **Tip:**

If the address also happens to be an item in the Point of Interest database, you can look up the item's phone number in the Waypoint Information list. With the address location selected by the cursor on the map, press **WPT**. The POI's Waypoint Information window appears, with the Go To Waypoint command highlighted. If you want to go ahead and navigate to the POI address, just press **ENT|EXIT**.



Map Page showing location of the address on the map, highlighted by cursor (left). This address is a business in the POI database, so you can display the POI information window, then navigate to it (center). This address is not in the POI database (right), so the Waypoint key will not display any information for this address.

## Find Any Item Selected by Map Cursor

On the Map Page: with a POI or map feature selected by the cursor press **WPT**. To return to the previous page, press **EXIT**.

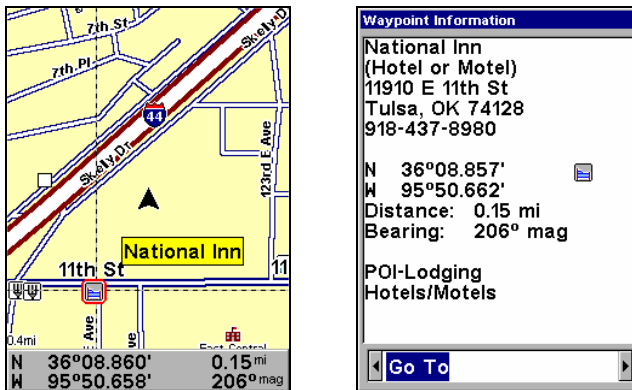

A POI selected by the cursor (left), POI information screen (right).

### NOTE:

Since the Go To waypoint command is highlighted, you can navigate to the selected POI by pressing **ENT|EXIT** while in the POI Waypoint Information screen.

## Find Interstate Highway Exits

1. From the Map Page, press **MENU** | ↓ to **HIGHWAY EXITS** | **ENT**, which calls up the Find Exit menu.

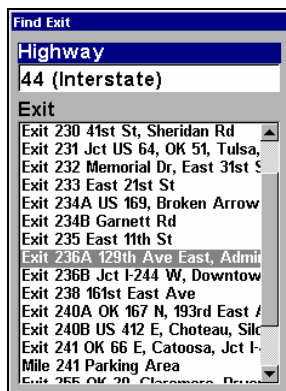
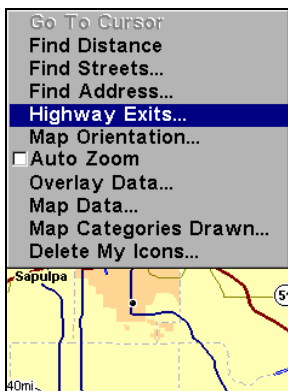

Find Highway Exits (left). Find Exit menu (right).

2. First, select a highway name by pressing **ENT**, which calls up the Find By Name menu. There are two highway search options: **A**. You can **spell out** the highway name in the top selection box. Press **↑** or **↓** to change the first letter, then press **→** to move the cursor to the next letter and repeat until the name is correct, then press **ENT|ENT**. **B**. Jump down to the lower selection list by pressing **ENT**, then press **↓** or **↑** to select a highway from the list, then press **ENT**.

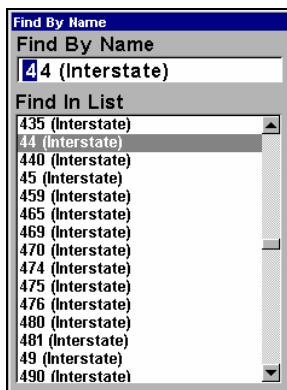

Find By Name menu.

3. Once you have selected a highway name you can then select an exit. Press **↓** to switch to the Exit List, then press **↓** or **↑** until you highlight the exit, then press **ENT**.

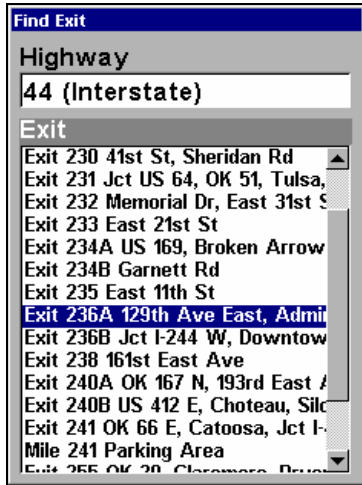

Find Exit menu, with an exit selected in the Exit List.

4. In the Exit Information screen you have two choices. **A.** Press **ENT** to navigate or "go to" the exit. **B.** Press **→|ENT** to find the exit on the map.

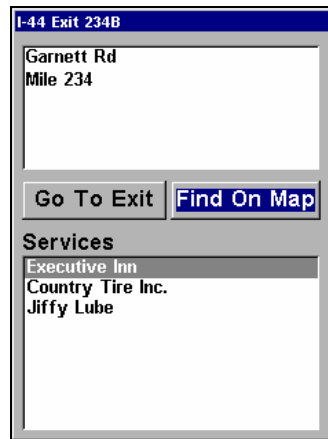
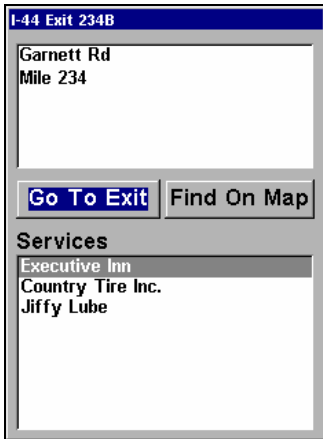

Go To Exit option (left). Find On Map option (right).

**Tip:**

You can also look up some additional information on the Exit Services located near this exit. Press **↓** to **SERVICES** | press **↓** or **↑** to select *Service Name* | **ENT**.

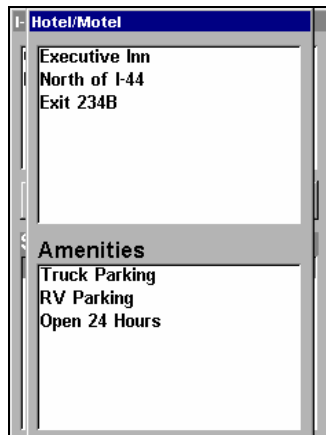
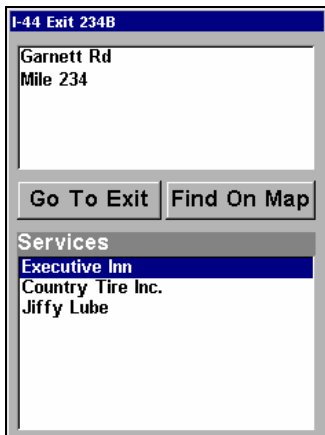

Exit Information screen (left). General location and amenities information (right).

## Find Map Places or Points of Interest (POI)

1. Press **WPT**, press  $\downarrow$  or  $\uparrow$  to select a map place or POI category, then press **ENT**. (To narrow your search, press  $\rightarrow$  or  $\leftarrow$  to select a subcategory before pressing **ENT**.) You will be given two options; Search By Nearest or By Name.

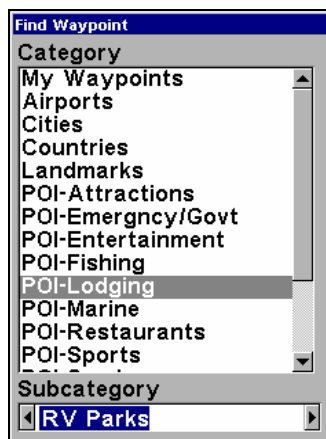
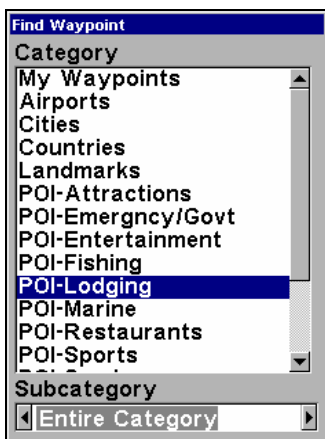

Find Waypoint menu with Lodging POI category selected (left). RV Parks subcategory selected (right).

2. **Search by nearest POI.** Press **ENT**. The "find by nearest" menu will show a "calculating" screen, then a list of the nearest POI's will appear. Press  $\downarrow$  or  $\uparrow$  to the selected POI and press **ENT** to call up the POI's Waypoint Information screen.

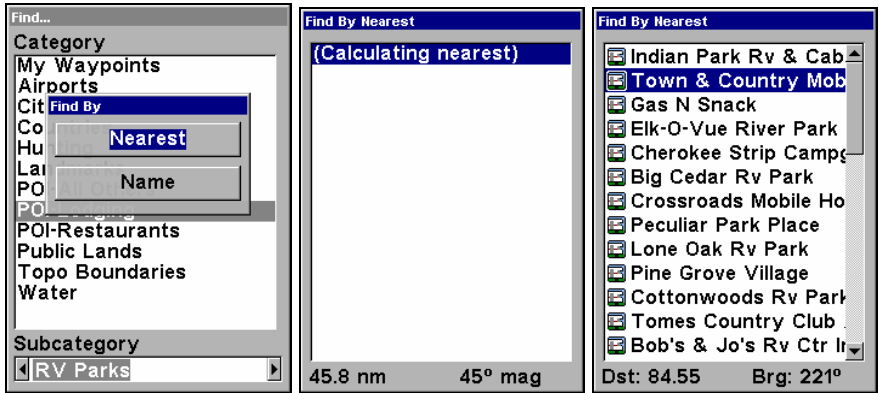

Find by Nearest option (left) with POI list (right).

3. Search by name of POI. Press ↓ to NAME|ENT. There are two options: A. You can spell out the POI in the top selection box. Press ↑ or ↓ to change the first letter, then press → to move the cursor to the next letter and repeat until the name is correct, then press ENT|ENT. B. Jump down to the lower selection list by pressing ENT, then press ↓ or ↑ to select a POI from the list, then press ENT to call up the POI's Waypoint Information screen.

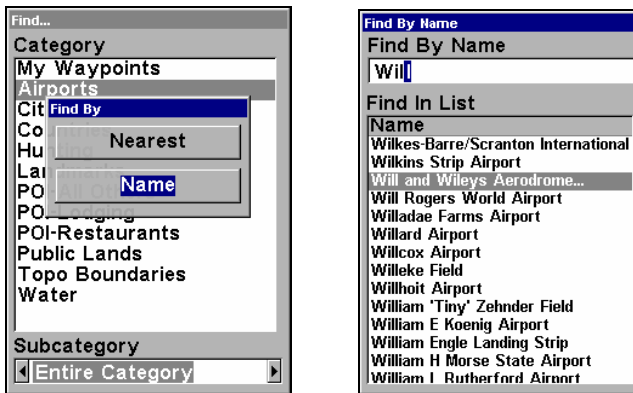

Find by Name option (left). Find by Name menu (right).

4. When the POI's Waypoint Information screen is displayed, you can choose to "Go To" the POI waypoint by pressing ENT or find it on the map by pressing→|ENT.

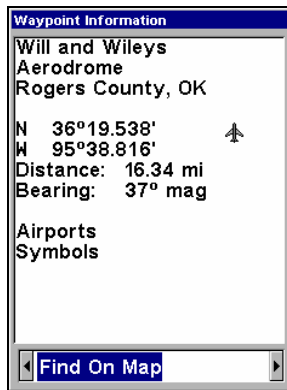
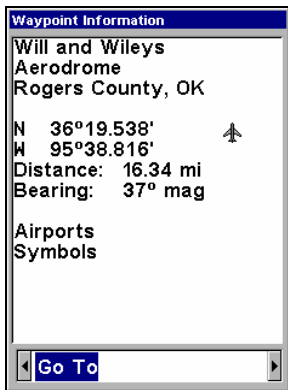

Go To POI option (left). Find on Map POI option (right).

## Find Streets or Intersections

### Find a Street

1. From the Map Page, press **MENU** | ↓ to **FIND STREETS** | **ENT** and the Find Streets Menu appears.

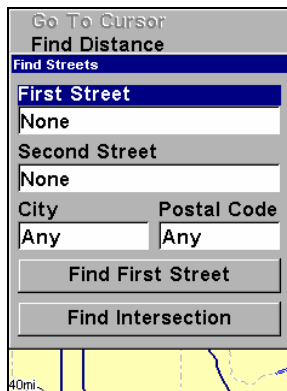
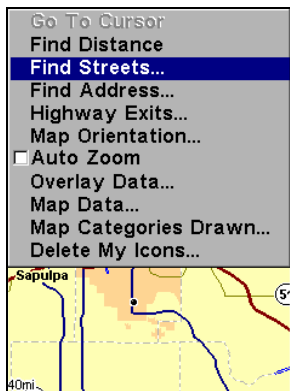

Find Streets command (left). Find Streets menu (right).

2. You must first fill in a street name in the First Street dialog box. Press **ENT** to display the Find By Name menu. There are two options:  
**A.** You can **spell out** the street in the top selection box. Press ↑ or ↓ to change the first letter, then press → to move the cursor to the next letter and repeat until the name is correct, then press **ENT** | **ENT**.  
**B.** Or you can jump down to the lower box and pick a street from the **selection list**. Press **ENT**, then press ↓ or ↑ to select a street from the list and press **ENT**.



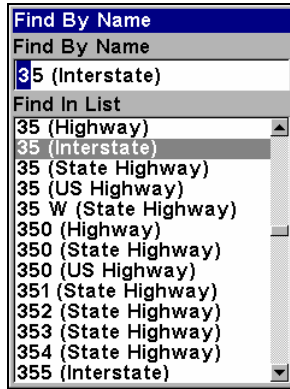

**Find Street By Name menu. Spell out name in the top box, or select from the list in the lower box.**

3. The Find Streets menu reappears with the street you're searching for in the First Street box. (In this example, it's I-35.) To search for that street, press ↓ to **FIND FIRST STREET|ENT**. A message appears asking you to wait while the unit finds the street. When the Streets Found list appears, press ↑ or ↓ to select the street you are searching for and press **ENT**.
4. The Map Page appears, with the cursor pointing to the found street.

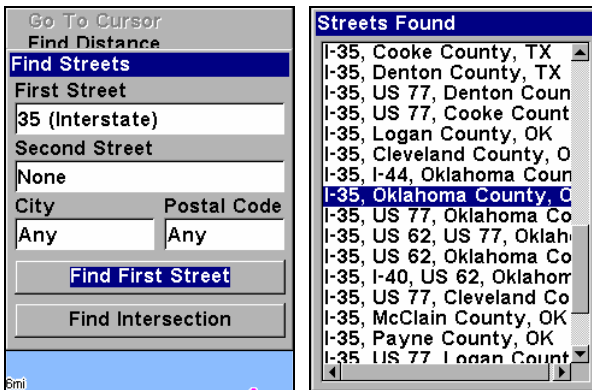

**Find Streets menu (left) with the Find First Street highlighted. Streets Found list (right).**



**Map Page showing results of a street search.  
The cursor points to the located street.**

If you want to navigate to the found street at the cursor location, just press **MENU | ENT | EXIT**.

### **Find an Intersection**

You must enter one street in the First Street dialog box and enter the next street in the Second Street dialog box.

1. From the Map Page, press **MENU | ↓** to **FIND STREETS | ENT** and the Find Streets Menu appears.
2. You must fill in a street name in the First Street dialog box. Press **ENT** to display the Find By Name menu. There are two options: **A.** You can **spell out** the street in the top selection box. Press **↑** or **↓** to change the first letter, then press **→** to move the cursor to the next letter and repeat until the name is correct, then press **ENT | ENT**. **B.** Or you can jump down to the lower box and pick a street from the **selection list**. Press **ENT**, then press **↓** or **↑** to select a street from the list and press **ENT**.
3. The Find Streets menu reappears with the street you're searching for in the First Street box. (In this example, it's I-35.)
4. Now fill in the second street. Press **↓** to **SECOND STREET | ENT** and the Find By Name menu appears again. Just like before, there are two options: **A.** You can **spell out** the second street in the top selection box. Press **↑** or **↓** to change the first letter, then press **→** to move the cursor to the next letter and repeat until the name is correct, then press **ENT | ENT**. **B.** Or you can jump down to the lower box and pick the second street from the **selection list**. Press **ENT**, then press **↓** or **↑** to select a street from the list and press **ENT**.

5. The Find Streets menu reappears with the first and second street dialog boxes filled in. In this example, we selected I-44 as our second street. You could now use similar techniques to select a city or Zip code, but your search will probably be faster if you leave those boxes blank. (You can specify a city and/or Zip code later on to narrow the search, if the resulting list is too long.)

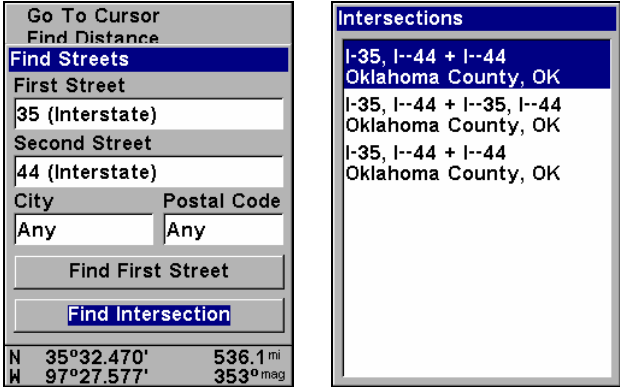

Find Intersection command highlighted (left).  
Intersections Found list (right).

6. To search for the intersection of the two streets, press ↓ to **FIND INTERSECTION** | **ENT**. A message appears asking you to wait while the unit finds the intersection. When the Intersections Found list appears, press ↑ or ↓ to select the intersection you are searching for and press **ENT**. (In the previous example, we selected the intersection of I-35 and I-44.)

7. The Map Page appears, with the cursor pointing to the found intersection. The intersection in our example is shown below.

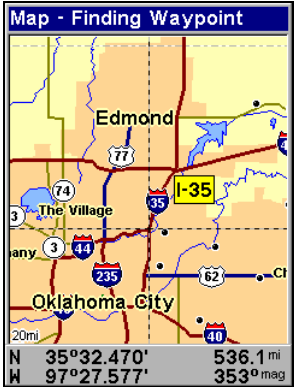

Map Page showing results of an intersection search.  
The cursor points to the located intersection.

If you want to navigate to the found intersection, just press **MENU | ENT | EXIT**.

## Find Waypoints

1. Press **WPT | ↑** to **MY WAYPOINTS | ENT**.
2. If searching for the *Nearest* waypoint, press **ENT**. If searching for the waypoint *By Name*, press to **↓ NAME | ENT**. (To search by name, jump to step 5.)

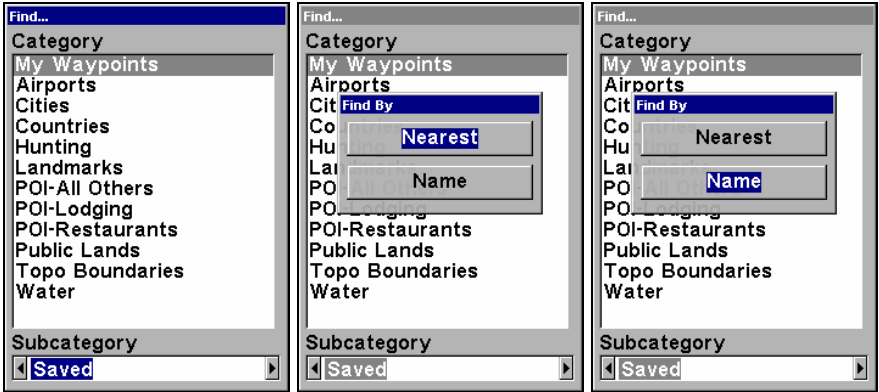

Find Waypoint menu (left). Find By Nearest command (center), Find by Name command (right).

3. If you're looking for nearest, the unit says it is calculating, then a list of waypoints appears. The closest is highlighted at the top of the list and the farthest at the bottom of the list.

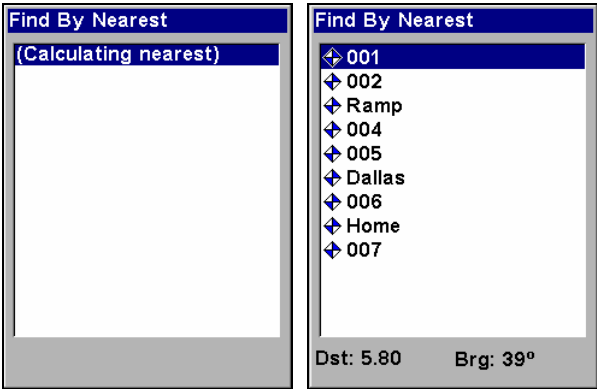

Calculating message (left). List of the nearest waypoints (right).

4. To see location information on the closest (highlighted) waypoint, press **ENT** and the Waypoint Information screen appears.

A. **To navigate** to the waypoint, press **ENT**. (The Go To Waypoint command is already highlighted.) The unit will show navigation information to the waypoint.

B. **To find** the waypoint, press **→** to **FIND ON MAP** | **ENT**. The Map Page appears with the cursor highlighting the found waypoint.

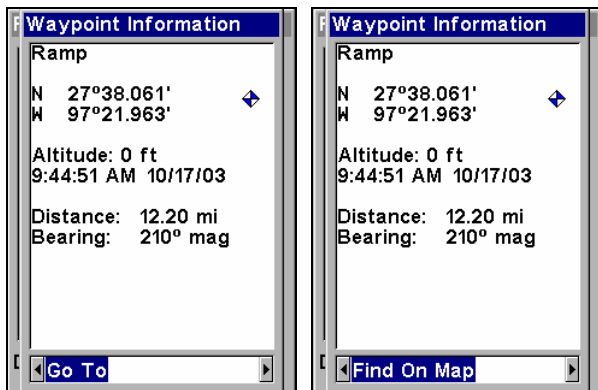

Waypoint Information screens with the Go To Waypoint command selected (left). Find on Map selected (right).

To clear these menus and return to the previous page, press **EXIT** repeatedly.

5. **If you're looking by name**, there are two options: **A.** You can **spell out** the name in the top selection box. Press **↑** or **↓** to change the first letter, then press **→** to move the cursor to the next letter and repeat until the name is correct, then press **ENT** | **ENT**. **B.** Or you can jump down to the lower selection list by pressing **ENT**, then press **↓** or **↑** to select a waypoint from the list, then press **ENT**. The waypoint information screen appears.

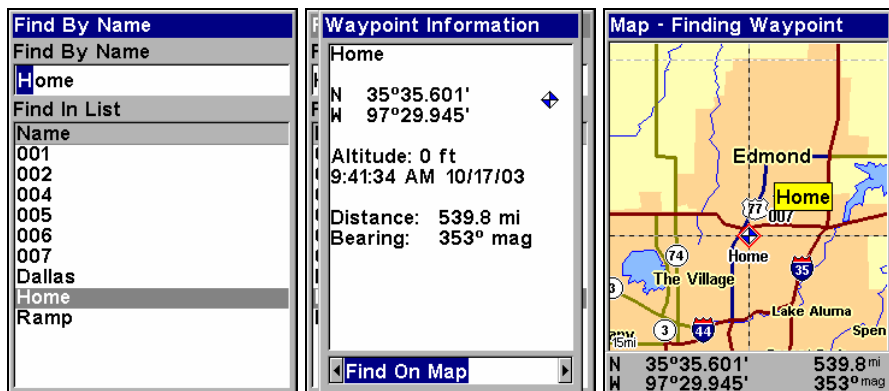

Find By Name menu (left). Waypoint Information screen (center). Found waypoint (right) is highlighted by cursor on Map Page.

A. *To navigate* to the waypoint, press **ENT**. (Go To Waypoint command is already highlighted.) The unit will show navigation information to the waypoint.

B. *To find* the waypoint, press **→** to **FIND ON MAP** | **ENT**. The Map Page appears with the cursor highlighting the found waypoint.

# Section 10: Supplemental Material

## Datums Used by This Unit

WGS 1984 Default	Zaire, Zambia and Zimbabwe	Australian Geodetic 1984 - Australia & Tasmania
Adindan Mean for Ethiopia, Sudan	Arc 1950 - Botswana  Arc 1950 - Burundi	Ayabelle Lighthouse - Djibouti
Adindan Burkina Faso	Arc 1950 - Lesotho  Arc 1950 - Malawi	Bellevue (IGN) - Efa- te & Erromango I- slands
Adindan Cameroon	Arc 1950 - Swaziland	Bermuda 1957 - Bermuda
Adindan Ethiopia	Arc 1950 - Zaire  Arc 1950 - Zambia	Bissau - Guinea- Bissau Bogota Observatory - Colombia
Adindan Mali	Arc 1950 - Zimbabwe	
Adindan Senegal	Arc 1960 - Mean for Kenya, Tanzania	Bukit Rimpah - Indo- nesia (Bangka & Beli- tung Islands)
Adindan Sudan	Ascension Island 1958 - Ascension Island	Camp Area Astro - Antarctica (McMurdo Camp Area)
Afgooye Somalia	Astro Beacon E 1945 - Iwo Jima	Campo Inchauspe - Argentina
Ain el Abd 1970 Bahrain	Astro DOS 71/4 - St. Helena Island	Canton Astro 1966 - Phoenix Islands
Ain el Abd 1970 Saudi Arabia	Astro Tern Island (FRIG) 1961 - Tern Island	Cape - South Africa
Anna 1 Astro 1965 Cocos Islands	Astronomical Station 1952 - Marcus Island	Cape Canaveral - Bahamas, Florida
Antigua Island Astro 1943; Antigua (Lee- ward Islands)	Australian Geodetic 1966 - Australia & Tasmania	Carthage - Tunisia  Switzerland
Arc 1950; Mean for Botswana, Lesotho, Malawi, Swaziland,		Chatham Island Astro 1971; New Zealand (Chatham Island)

Chua Astro Paraguay	European 1950 England, Channel Islands, Ireland, Scotland, Shetland Islands	L.C. 5 Astro 1961 Cayman Brac Island
Corrego Alegre Brazil		Leigon Ghana
Dabola Guinea	European 1950 Finland, Norway	Liberia 1964 Liberia
Djakarta (Batavia) Indonesia (Sumatra)	European 1950 Greece	Luzon Philippines (Exclud- ing Mindanao)
DOS 1968 New Georgia Islands (Gizo Island)	European 1950 Iran	Luzon Philippines (Min- danao)
Easter Island 1967 Easter Island	European 1950 Italy (Sardinia)	Mahe 1971 Mahe Island
European 1950 Mean for Austria, Belgium, Denmark, Finland, France, West Germany, Gi- braltar, Greece, Italy, Luxembourg, Nether- lands, Norway, Por- tugal, Spain, Swe- den, Switzerland	European 1950 (Sicily) European 1950 Malta	Massawa Ethiopia (Eritrea)
	Ireland 1965 Ireland	Merchich Morocco
	ISTS 061 Astro 1968 South Georgia Is- lands	Midway Astro 1961 Midway Islands
European 1950 Mean for Austria, Denmark, France, West Germany, Netherlands, Switzer- land	ISTS 073 Astro 1969 Diego Garcia	Minna Cameroon
	Johnston Island 1961 Johnston Island	Minna Nigeria
European 1950 Mean for Iraq, Israel, Jordan, Lebanon, Kuwait, Saudi Arabia, Syria	Kandawala Sri Lanka	Montserrat Island Astro 1958; Montser- rat (Leeward Islands)
	Kerguelen Island 1949 Kerguelen Island	M'Poraloko Gabon, Nahrwan, Oman (Masirah Is- land)
European 1950 Cyprus	Kertau 1948 West Malaysia & Singapore	Nahrwan Saudi Arabia
European 1950 Egypt	Kusaie Astro 1951 Caroline Islands	Nahrwan United Arab Emirates



Naparima BWI Trinidad & Tobago	North American 1927 Canada (Alberta, British Columbia)	Old Hawaiian Mean for Hawaii, Kauai, Maui, Oahu
North American 1927 Mean for Antigua, Barbados, Barbuda, Caicos Islands, Cuba, Dominican Republic, Grand Cayman, Jamaica, Turks Islands	North American 1927 Canada (Manitoba, Ontario)	Old Hawaiian Hawaii
North American 1927 Mean for Belize, Cos- ta Rica, El Salvador, Guatemala, Hondu- ras, Nicaragua	North American 1927 Canada (New Brunswick, New- foundland, Nova Sco- tia, Quebec)	Old Hawaiian Kauai
North American 1927 Mean for Canada	North American 1927 Canada (Northwest Territories, Sas- katchewan)	Old Hawaiian Maui
North American 1927 Mean for CONUS (Continental United States)	North American 1927 Canada (Yukon)	Old Hawaiian Oahu
North American 1927 Mean for CONUS (East of Mississippi River) including Lou- isiana, Missouri, Min- nesota	North American 1927 Cuba	Oman Oman
North American 1927 Mean for CONUS (West of Mississippi River)	North American 1927 Greenland (Hayes Peninsula)	Ordinance Survey Great Britain 1936 - Mean for England, Isle of Man, Scotland, Shetland Islands, Wales
North American 1927 Alaska	North American 1927 Mexico	Ordinance Survey Great Britain 1936 - England
North American 1927 Bahamas (Except San Salvador Island)	North American 1927 Alaska, Canada, CONUS	Ordinance Survey Great Britain 1936 - England, Isle of Man, Wales
North American 1927 Bahamas (San Sal- vador Island)	North American 1983 Central America, Mexico	Ordinance Survey Great Britain 1936 - Scotland, Shetland Islands
	Observaorio Metereo 1939; Azores (Corvo & Flores Islands)	Ordinance Survey Great Britain 1936 - Wales
	Old Egyptian 1907 Egypt	Pico de las Nieves Canary Islands
		Pitcairn Astro 1967 Pitcairn Island

Point 58		Tokyo
Sweden	South American 1969 Chile	Mean for Japan, Korea, Okinawa
Santo (DOS) 1965 Espirito Santo Island	South American 1969 Colombia	Tokyo Japan
Sao Braz Azores (Sao Miguel, Santa Maria Islands)	South American 1969 Ecuador	Tokyo Korea
Sapper Hill 1943 East Falkland Island	South American 1969 Ecuador (Baltra, Galapagos)	Tokyo
Schwarzeck Nambia	South American 1969 Guyana	Okinawa
Selvagem Grande Salvage Islands	South American 1969 Paraguay South American 1969 Peru	Tristan Astro 1968 Tristan da Cunha
SGS 85 Soviet Geodetic System 1985	South American 1969 Trinidad & Tobago	Viti Levu 1916 Fiji (Viti Levu Island)
South American 1969 Mean for Argentina, Bolivia, Brazil, Chile, Colombia, Ecuador, Guyana, Paraguay, Peru, Trinidad & Tobago, and Venezuela	South American 1969 Venezuela	Wake
South American 1969 Argentina	South Asia	Eniwetok 1960
South American 1969 Bolivia	Singapore	Marshall Islands
South American 1969 Brazil	Tananarive Observatory 1925; Madagascar	Wake Island Astro 1952 Wake Atoll
	Timbalai 1948 Brunei, East Malaysia (Sabah, Sarawak)	WGS 1972 Global Definition
		Yacare Uruguay
		Zanderij Suriname

# FCC Compliance

This device complies with Part 15 of the U.S. Federal Communications Commission (FCC) Rules. Operation is subject to the following two conditions: (1) this device may not cause harmful interference, and (2) this device must accept any interference received, including interference that may cause undesired operation.

Changes or modifications not expressly approved by the manufacturer could void the user's authority to operate the equipment.

Note:

This equipment has been tested and found to comply with the limits for a Class B digital device, pursuant to Part 15 of the FCC Rules. These limits are designed to provide reasonable protection against harmful interference in a residential installation. This equipment generates, uses and can radiate radio frequency energy and, if not installed and used in accordance with the instructions, may cause harmful interference to radio communications. However, there is no guarantee that interference will not occur in a particular installation. If this equipment does cause harmful interference to radio or television reception, which can be determined by turning the equipment off and on, the user is encouraged to try to correct the interference by one or more of the following measures:

Reorient or relocate the receiving antenna.

Increase the separation between the equipment and receiver.

Connect the equipment into an outlet on a circuit different from that to which the receiver is connected.

Consult the factory customer service department for help.

# Notes

# Notes

# Notes

## LOWRANCE DATABASES LICENSE AGREEMENT

THIS IS a LEGAL AGREEMENT BETWEEN THE END-USER WHO FIRST PURCHASES THIS PRODUCT AS a CONSUMER ITEM FOR PERSONAL, FAMILY, OR HOUSEHOLD USE ("YOU") AND LOWRANCE ELECTRONICS, a DIVISION OF LEI, THE MANUFACTURER OF THIS PRODUCT ("WE", "OUR", OR "US"). USING THE PRODUCT ACCOMPANIED BY THIS LICENSE AGREEMENT CONSTITUTES ACCEPTANCE OF THESE TERMS AND CONDITIONS. IF YOU DO NOT ACCEPT ALL TERMS AND CONDITIONS, PROMPTLY RETURN THE PRODUCT WITHIN 30 DAYS OF PURCHASE. PLEASE RETURN USING THE ENCLOSED UPS SHIPPING LABEL AND INCLUDE: PROOF OF PURCHASE, NAME, ADDRESS, AND PHONE NUMBER. YOUR PURCHASE PRICE AND ANY APPLICABLE TAXES WILL BE REFUNDED. PLEASE ALLOW 4-6 WEEKS TO PROCESS YOUR REFUND.

1. This License Agreement applies to the one or more databases that your product may contain. We refer to these singly as a "Database" and together as the "Databases." Your product may thus include the "WBS Database" which contains worldwide background surface mapping data, the "SmartMap Database" which contains inland mapping data, or other Databases.
2. The Databases that your product may contain are licensed, not sold. We grant to you the nonexclusive, nonassignable right to use these Databases for supplemental navigation reference purposes, but only as long as you comply with the terms and conditions of this License Agreement. We reserve the right to terminate this license if you violate any aspect of this License Agreement. You are responsible for using official government charts and prudent navigation for safe travel.
3. The Databases housed in your product are protected by the copyright notices appearing on the product or its screen(s). You may NOT modify, adapt, translate, reverse engineer, decompile, disassemble, rent, lease, or resell any Database, and you may NOT create derivative works based upon any Database or its contents.. Any unauthorized reproduction, use, or transfer of a Database may be a crime and may subject you to damages and attorney fees.
4. This License Agreement will terminate immediately without prior notice from us if you fail to comply with or violate any of the provisions of this Agreement. Upon termination, you will promptly return all products containing one or more Databases to us.
5. Prices and programs are subject to change without notice.
6. This License Agreement shall be governed by the laws of the State of Oklahoma and comprises the complete and exclusive understanding between you and us concerning the above subject matter.

## **DATABASES LIMITED WARRANTY**

"We", "our", or "us" refers to Lowrance Electronics, a division of LEI, the manufacturer of this product. "You" or "your" refers to the first person who purchases the product as a consumer item for personal, family, or household use. The Databases Limited Warranty applies to the one or more databases that your product may contain. We refer to each of these as a "Database" or together as the "Databases." Your product may thus include the "WBS Database" which contains worldwide background surface mapping data, the "SmartMap Database" which contains inland mapping data, or other Databases.

We warrant to you that we have accurately compiled, processed, and reproduced the portions of the source material on which the Databases are based. However, we are under no obligation to provide updates to the Databases, and the data contained in the Databases may be incomplete when compared to the source material. **WE MAKE NO EXPRESS OR IMPLIED WARRANTY OF ANY KIND ABOUT THE ACCURACY OF THE SOURCE MATERIAL ITSELF, INCLUDING BUT NOT LIMITED TO IMPLIED WARRANTIES OF MERCHANTABILITY OR FITNESS FOR a PARTICULAR PURPOSE.**

If there is a defect in any Database, your exclusive remedy shall be, at our option, either a refund of the price you paid for the product containing the defective Database or a replacement of such product. **WE WILL NOT UNDER ANY CIRCUMSTANCES BE LIABLE TO ANYONE FOR ANY SPECIAL, CONSEQUENTIAL, INCIDENTAL, OR OTHER INDIRECT DAMAGE OF ANY KIND.**

Some states do not allow the exclusion or limitation of incidental or consequential damages, so the above limitations or exclusions may not apply to you.

This warranty does NOT apply in the following circumstances: (1) when the product has been serviced or repaired by anyone other than us, (2) when the product has been connected, installed, combined, altered, adjusted, or handled in a manner other than according to the instructions furnished with the product, (3) when any serial number has been effaced, altered, or removed, or (4) when any defect, problem, loss, or damage has resulted from any accident, misuse, negligence, or carelessness, or from any failure to provide reasonable and necessary maintenance in accordance with the instructions of the owner's manual for the product.

We reserve the right to make changes or improvements in our products from time to time without incurring the obligation to install such improvements or changes on equipment or items previously manufactured.

This warranty gives you specific legal rights and you may also have other rights which may vary from state to state.

Your remedies under this warranty will be available so long as you can show in a reasonable manner that the defect occurred within one (1) year from the date of your original purchase, and we must receive your warranty claim no later than 30 days after such 1-year period expires. Your claim must be substantiated by a dated sales receipt or sales slip.



## **LOWRANCE ELECTRONICS FULL ONE-YEAR WARRANTY**

"We," "our," or "us" refers to LOWRANCE ELECTRONICS, a division of LEI, the manufacturer of this product. "You" or "your" refers to the first person who purchases this product as a consumer item for personal, family, or household use.

We warrant this product against defects or malfunctions in materials and workmanship, and against failure to conform to this product's written specifications, all for one (1) year from the date of original purchase by you. WE MAKE NO OTHER EXPRESS WARRANTY OR REPRESENTATION OF ANY KIND WHATSOEVER CONCERNING THIS PRODUCT. Your remedies under this warranty will be available so long as you can show in a reasonable manner that any defect or malfunction in materials or workmanship, or any non-conformity with the product's written specifications, occurred within one year from the date of your original purchase, which must be substantiated by a dated sales receipt or sales slip. Any such defect, malfunction, or non-conformity which occurs within one year from your original purchase date will either be repaired without charge or be replaced with a new product identical or reasonably equivalent to this product, at our option, within a reasonable time after our receipt of the product. If such defect, malfunction, or non-conformity remains after a reasonable number of attempts to repair by us, you may elect to obtain without charge a replacement of the product or a refund for the product. THIS REPAIR, OR REPLACEMENT OR REFUND (AS JUST DESCRIBED) IS THE EXCLUSIVE REMEDY AVAILABLE TO YOU AGAINST US FOR ANY DEFECT, MALFUNCTION, OR NON-CONFORMITY CONCERNING THE PRODUCT OR FOR ANY LOSS OR DAMAGE RESULTING FROM ANY OTHER CAUSE WHATSOEVER. WE WILL NOT UNDER ANY CIRCUMSTANCES BE LIABLE TO ANYONE FOR ANY SPECIAL, CONSEQUENTIAL, INCIDENTAL, OR OTHER INDIRECT DAMAGE OF ANY KIND.

Some states do not allow the exclusion or limitation of incidental or consequential damages, so the above limitations or exclusions may not apply to you.

This warranty does NOT apply in the following circumstances: (1) when the product has been serviced or repaired by anyone other than us; (2) when the product has been connected, installed, combined, altered, adjusted, or handled in a manner other than according to the instructions furnished with the product; (3) when any serial number has been effaced, altered, or removed; or (4) when any defect, problem, loss, or damage has resulted from any accident, misuse, negligence, or carelessness, or from any failure to provide reasonable and necessary maintenance in accordance with the instructions of the owner's manual for the product.

We reserve the right to make changes or improvements in our products from time to time without incurring the obligation to install such improvements or changes on equipment or items previously manufactured.

This warranty gives you specific legal rights and you may also have other rights which may vary from state to state.

REMINDER: You must retain the sales slip or sales receipt proving the date of your original purchase in case warranty service is ever required.

**LOWRANCE ELECTRONICS  
PO BOX 669, CATOOSA, OK 74015  
(800) 324-1354**

## **How to Obtain Service...**

### **...in the USA:**

We back your investment in quality products with quick, expert service and genuine Lowrance replacement parts. If you're in the United States and you have technical, return or repair questions, please contact the Factory Customer Service Department. Before any product can be returned, you must call customer service to determine if a return is necessary. Many times, customer service can resolve your problem over the phone without sending your product to the factory. To call us, use the following toll-free number:

**800-324-1354**

8 a.m. to 5 p.m. Central Standard Time, M-F

*Lowrance Electronics may find it necessary to change or end our shipping policies, regulations, and special offers at any time. We reserve the right to do so without notice.*

### **...in Canada:**

If you're in Canada and you have technical, return or repair questions, please contact the Factory Customer Service Department. Before any product can be returned, you must call customer service to determine if a return is necessary. Many times, customer service can resolve your problem over the phone without sending your product to the factory. To call us, use the following toll-free number:

**800-661-3983**

**905-629-1614 (not toll-free)**

8 a.m. to 5 p.m. Eastern Standard Time, M-F

### **...outside Canada and the USA:**

If you have technical, return or repair questions, contact the dealer in the country where you purchased your unit. To locate an Lowrance dealer near you, visit our web site at [www.lowrance.com](http://www.lowrance.com) or consult your telephone directory for listings.

# Accessory Ordering Information for all countries

To order Lowrance GPS accessories such as power cables or MMC cards, please contact:

1) Your local marine dealer, sporting goods or consumer electronics store. Most quality dealers that handle marine electronic equipment or other consumer electronics should be able to assist you with these items.

To locate a Lowrance dealer near you, visit our web site, [www.lowrance.com](http://www.lowrance.com) and click on Support and then click Dealer Locator. Or, you can consult your telephone directory for listings.

2) U.S. customers: LEI Extras Inc., PO Box 129, Catoosa, OK 74015-0129  
Call 1-800-324-0045 or visit our web site [www.lei-extras.com](http://www.lei-extras.com).

3) Canadian customers can write:

Lowrance/Eagle Canada, 919 Matheson Blvd. E. Mississauga, Ontario L4W2R7 or fax 905-629-3118.

## Shipping Information

If it becomes necessary to send a product for repair or replacement, you must first receive a return authorization number from Customer Service. Products shipped without a return authorization will not be accepted. When shipping, we recommend you do the following:

1. Please do not ship knobs or mounting brackets with gimbal units.
2. If your unit saves sonar logs or GPS data files to memory cards, make sure you have saved the data to a memory card and that the card has been removed from the unit, otherwise your data will be lost.
3. If you are sending a check for repair, please place your check in an envelope and tape it to the unit.
4. For proper testing, include a brief note with the product describing the problem. Be sure to include your name, return shipping address and a daytime telephone number. An e-mail address is optional but useful.
5. Pack the unit in a suitable size box with packing material to prevent any damage during shipping.
6. Write the Return Authorization (RA) number on the outside of the box underneath your return address.
7. For your security, you may want to insure the package through your shipping courier. Lowrance does not assume responsibility for goods lost or damaged in transit.



Visit our web site:



Lowrance Pub. 988-0152-221

Printed in USA 121206

© Copyright 2006  
All Rights Reserved  
Lowrance Electronics, Inc.