

**Raymarine®**

MULTIFUNCTION

# Sensor and Accessory Guide

For Raymarine C and E-Series  
Multifunction Displays



# Sensor and Accessory Guide

## Radar

Raymarine's scanners deliver unparalleled performance. The compact 2kW and 4kW radomes provide range scales of 24nm and 48nm while the high performance open arrays offer 72nm-maximum range and improved target resolution.

## Open array or radome?

Choose a radome scanner when mounting space is limited or restricted by rigging. Lightweight and rugged, radomes are ideal for sailboats and powerboats and provide exceptional performance even in the most challenging conditions. Choose an open array scanner for enhanced performance and range. These larger scanners are equipped with a more efficient antenna (increased gain) and narrower beam widths for improved target separation and resolution. Open array scanners are ideal for powerboats, commercial vessels and larger sailing vessels that demand maximum performance.

## RD218 2kW and RD424 4kW Radome Scanners

New radomes for Raymarine's C and E-Series multifunction navigations displays. The 18" 2kW dome is compact, lightweight and offers 24nm range while the larger 24" dome offers 48NM maximum range with the added performance boost of 4 kilowatts of power and a larger antenna.



## Features include:

- Plug and Play compatibility with Raymarine C and E-Series multifunction navigation displays
- Raymarine's Auto GST™ automatic control of Gain, Sea Clutter and Tune
- New and improved dome housing
- Improved radiation pattern and bearing resolution using Propagation Enhancing Geometry
- Advanced microprocessor controlled transmitter receiver features 8 Pulse width/PRF settings, providing enhanced target returns though every range scale
- New receiver and antenna design delivers improved sensitivity, signal to noise ratio, and a lower overall receive noise figure
- Same mounting pattern as previous generation radomes

## Dimensions

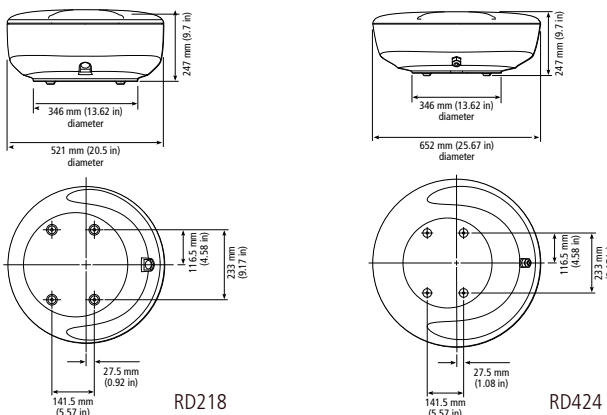

## Radome Specifications

	2kW, 18" Radome	4kW, 24" Radome
<b>PHYSICAL</b>		
Overall Dimensions	20.1" x 9.7"	25.67" x 9.7"
Product Weight lbs (kg)	16.5 (7.5)	18.74 (8.5)
<b>POWER</b>		
Nominal Voltage (volts DC)	12v, 24v systems	12v, 24v systems
Absolute voltage range	10.8-32v DC	10.8-32V DC
Power consumption (typical/standby)	28W transmit, 9W standby	34W transmit, 10W standby
<b>ENVIRONMENTAL</b>		
Temperature range	-10°C to +55°C Operating -20°C to +70°C Non-Operating	-10°C to +55°C Operating -20°C to +70°C Non-Operating
Humidity	Up to 95%	Up to 95%
Waterproofing standard	IPX6	IPX6
<b>SCANNER FEATURES</b>		
Maximum range scale	24nm	48nm
Transmitter frequency	9410 +/- 30MHz	9410 +/- 30MHz
Peak power output	2 kW	4 kW
Pulse length/PRF	8 (auto target/expand)	8 (auto target/expand)
Horizontal beam width -3dB	5.2°	3.9°
Vertical beam width -3dB	25°	25°
Rotation Rate	24 rpm	24 rpm

Complete scanner specifications are available online at [www.raymarine.com](http://www.raymarine.com).

## Radome Ordering Information

PART #	DESCRIPTION
E52065	RD218 Radome Scanner w/15M Cable
E52079	RD218 Radome Scanner Only
E52067	RD424 Radome Scanner w/15M Cable
E52080	RD424 Radome Scanner Only

## 4kW and 10kW Open Array Radar Scanners

Designed to meet the needs of the most demanding boaters, Raymarine's open array scanners are available with 4kW or 10 kW power output, and a 4-foot or 6-foot array. Compatible with both C-Series and E-Series Multifunction Displays, these open arrays deliver best-in-class performance.



### Features include:

- Plug and Play compatibility with Raymarine C and E-Series multifunction navigation displays
- Raymarine's Auto GST™ automatic control of Gain, Sea Clutter and Tune
- Narrow horizontal beam widths for enhanced target separation
- Increased power output for improved long range performance
- Quiet operation
- Self-parking array always stops the antenna facing forward maintaining a ship-shape appearance.

### Open Array Ordering Information

PART #	DESCRIPTION
T52001-S	55 4kW scanner (pedestal, 4' array and 15m cable)
T52013-S	75 4kW scanner (pedestal, 6' array and 15m cable)
T52012-S	95 10kW scanner (pedestal, 4' array and 15m cable) (24v DC only)
T52014-S	115 10kW scanner (pedestal, 6' array and 15m cable) (24v DC only)

### Open Array Specifications

	55 4kW, 48" Open Array	75 4kW, 72" Open Array	95 10kW, 48" Open Array	115 10kW, 72" Open Array
<b>PHYSICAL</b>				
Overall Dimensions	Pedestal: 16.8" x 11.65" x 16" Array length: 48"	Pedestal: 16.8" x 11.65" x 16" Array length: 72"	Pedestal: 16.8" x 11.65" x 16" Array length: 48"	Pedestal: 16.8" x 11.65" x 16" Array length: 72"
Product Weight lbs (kg)	66.2 (30)	73.7 (33.4)	66.2 (30)	73.7 (33.4)
<b>POWER</b>				
Nominal Voltage (volts DC)	12v, 24v, 32v systems	12v, 24v, 32v systems	24v, 32v systems	24v, 32v systems
Absolute voltage range	10.7-44 volts	10.7-44 volts	20.0-44 volts	20.0-44 volts
Power consumption (typical/standby)	46/9.2 watts	46/9.2 watts	80/11 watts	90/11 watts
<b>ENVIRONMENTAL</b>				
Temperature range	-10°C to +55°C Operating -20°C to +70°C Non-Operating	-10°C to +55°C Operating -20°C to +70°C Non-Operating	-10°C to +55°C Operating -20°C to +70°C Non-Operating	-10°C to +55°C Operating -20°C to +70°C Non-Operating
Humidity	Up to 95%	Up to 95%	Up to 95%	Up to 95%
Waterproofing standard	CFR46	CFR46	CFR46	CFR46
<b>SCANNER FEATURES</b>				
Maximum range scale	72nm	72nm	72nm	72nm
Transmitter frequency	9410 +/- 30 MHz	9410 +/- 30 MHz	9410 +/- 30 MHz	9410 +/- 30 MHz
Peak power output	4 kW	4 kW	10 kW	10 kW
Pulse length/PRF	8 (auto target/expand)	8 (auto target/expand)	8 (auto target/expand)	8 (auto target/expand)
Horizontal beam width -3dB	1.85°	1.15°	1.85°	1.15°
Vertical beam width -3dB	25°	25°	25°	25°
Rotation Rate	24 rpm	24 rpm	24 rpm	24 rpm

### Dimensions

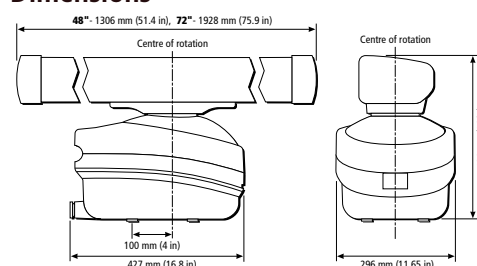

# Sensor and Accessory Guide

## Digital Sounder Module

The DSM300 Digital Sounder Module brings the benefits of Raymarine's award-winning HD Digital™ fish finding technology to the C-Series and E-Series Multifunction displays. With dual frequency output and up to 1000 Watts of transmit power, the DSM300's patented adaptive receiver technology precisely targets fish and bottom structure with amazing clarity.



**HD DIGITAL**

### Features include:

- HD Digital sonar technology delivers superior fish detection and bottom discrimination
- 600 or 1000 Watt RMS Output power (dependant on transducer selected)
- Dual frequency (50/200 kHz) for excellent inshore and offshore performance
- Hands-free HD Digital™ technology automatically adjusts more than 220 sonar parameters per second and virtually eliminates clutter
- HD Digital™ adaptive receiver technology precisely targets fish and bottom structure with amazing clarity
- Connects to optional through-hull, transom mount or in-hull transducers

## DSM300 Specifications

	DSM300 Digital Sounder Module
<b>PHYSICAL</b>	
Overall Dimensions	10.76" x 7.37" x 2.43"
Product Weight lbs (kg)	2.2 (1.0)
<b>POWER</b>	
Nominal Voltage (volts DC)	12v and 24V systems
Absolute voltage range (volts DC)	10.7-32 volts
Power consumption (typical) watts	30W
<b>ENVIRONMENTAL</b>	
Temperature range	-10°C to +50°C Operating -20°C to +70°C Non-operating
Humidity	Up to 95%
Waterproofing standard	CFR46 and IPX6
<b>KEY FEATURES</b>	
Nominal Power Output (watts RMS)	1000 or 600 watts (depends on transducer type)
Frequency	Dual 200 kHz/50 kHz

## DSM300 Ordering Information

PART #	DESCRIPTION
E63069	DSM300 Digital Sounder Module

For complete DSM300 specifications please visit us online at [www.raymarine.com](http://www.raymarine.com).

## Dimensions

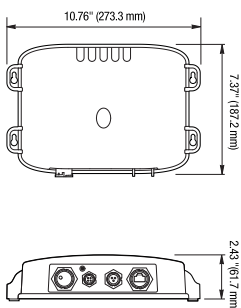

**HD DIGITAL**

## DSM300 Compatible Transducers and Accessories

Installing the right transducer is vital to getting the most out of your fishfinder. Raymarine offers a range of transducers designed for a variety of vessel types and performance requirements. For more information on choosing a transducer please visit [www.raymarine.com](http://www.raymarine.com) or talk to your local authorized Raymarine dealer.



E66054



E66019



E66008



E66081



E66076



E66056



E66057



E66013



E66014



E66015



E66082



E66079



E66080

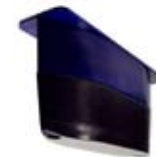

E66075





E66071



E66072

## DSM300 Transducer Ordering Information

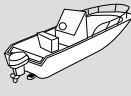
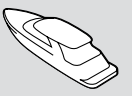
Raymarine offers a wide array of DSM300 compatible depth transducers to fit just about every boat and every budget. For more help on selecting the right transducer talk to your local Raymarine dealer or visit us online at [www.raymarine.com](http://www.raymarine.com).

PART #	BODY STYLE	MATERIAL	FEATURES			PERFORMANCE	MAX POWER	APPLICATIONS		
			DEPTH	SPEED	TEMP			 OUTBOARD POWER	 INBOARD POWER	 SAIL
<b>Transom Mount Transducers</b>										
E66054	P66	Plastic	•	•	•	Good	600w	•		
E66019	ST69	Plastic		•	•	N/A	N/A	•	•	
<b>In-Hull Transducers</b>										
E66008	P79	Plastic	•			Good	600w	•	•	•
E66081	M260	Urethane	•			Best	1000w	•	•	•
E66076	R199	Urethane	•			Ultimate	2000w	•	•	•
<b>Through-hull Transducers</b>										
E66056	B744V	Bronze	•	•	•	Good	600w	•	•	
E66057	B744VL	Bronze	•	•	•	Good	600w	•	•	
E66013	P319	Plastic	•			Good	600w	•	•	•
E66014	B117	Bronze	•			Good	600w	•	•	•
E66015	SS555	Stainless Steel	•			Good	600w	•	•	•
E66082	B258	Bronze	•		•	Better	1000w		•	
E66079	B260	Bronze	•		•	Best	1000w		•	
E66080	SS560	Stainless Steel	•		•	Best	1000w		•	
E66075	R99	Bronze/ Urethane	•		•	Ultimate	2000w		•	
E66071	P120-ST800	Plastic		•	•	N/A	N/A	•	•	•
E66072	B120-ST800	Bronze		•	•	N/A	N/A	•	•	•



# Sensor and Accessory Guide

## Raystar 125 GPS Sensor

Compact and accurate the Raystar 125 Satellite Differential GPS Receiver provides pinpoint accuracy to Raymarine's C-Series and E-Series Multifunction displays. The Raystar 125 outputs either SeaTalk or NMEA 0183, and is fully compatible with Raymarine SeaTalk instruments and autopilots.

A self contained waterproof GPS receiver and antenna combined, the Raystar 125 delivers accuracy better than 5 meters by decoding GPS correction signals from the WAAS (Wide Area Augmentation System.)



### Features include:

- SeaTalk or NMEA 0183 compatible
- 12 Channel GPS Receiver
- Built-in LED diagnostic indicator
- SDGPS accuracy to 5 meters or better
- SeaTalk or NMEA 0183 compatible
- Pole or flush mountable

## Specifications

RAYSTAR 125 GPS SENSOR	
<b>PHYSICAL</b>	
Overall dimensions (DxH)	Diameter 3.74" x 3.57"
Product Weight lbs (kg)	0.29 (0.13)
<b>POWER</b>	
Absolute voltage range (volts DC)	9-32 volts ( in NMEA mode) 9-18 volts (in SeaTalk mode)
Power consumption (typical) watts	1.2W
<b>ENVIRONMENTAL</b>	
Temperature range	-10°C to +70°C (operating) -20°C to +70°C (non-operating)
Humidity	Up to 95%
Waterproofing standard	CFR46
<b>KEY FEATURES</b>	
Satellite differential type	WAAS/EGNOS/MSAS
Differential beacon ready	With RTCM input
Position accuracy (RMS)	<5m with SDGPS
Speed accuracy (RMS)	<0.3 kts.
Data output	SeaTalk or NMEA 0183 (configured during installation)

## Ordering Information

PART #	DESCRIPTION
E32042	Raystar 125 SDGPS Sensor

For complete RAYSTAR125 specifications please visit us online at [www.raymarine.com](http://www.raymarine.com).

## Dimensions

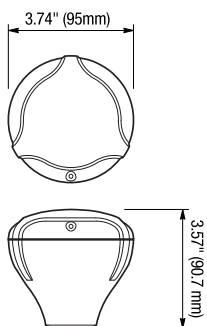

## CAM100 Day and Night Vision Marine Video Camera

The CAM100 is a day and night vision camera that instantly transforms Raymarine E-Series into a powerful onboard video observation system. Improve docking safety by monitoring blind spots or keep track of the engine room and crew from the helm. Use multiple cameras for a total view of your vessel's surroundings. The camera has a highly sensitive IR sensor to switch from true color to black and white night vision mode.



### Features include:

- Plug and play with Raymarine E Series
- Automatic switching between true color (day) and black and white (night) use
- Automatic IR LED on/off with photo sensor
- Excellent color reproduction
- NTSC or PAL versions available
- Up to 15m (49') total darkness visibility in night mode (black and white)

## Specifications

CAM100	
<b>PHYSICAL</b>	
Overall dimensions (LxH) with mount	5.85" x 4.1"
Product Weight lbs (kg)	0.63 (0.28)
<b>POWER</b>	
Operating voltage	12V DC (+30% to -10%)
Power consumption	130 mA Day, 280 mA Night IR on @ 12V DC
<b>ENVIRONMENTAL</b>	
Temperature range	-15°C to +55°C (operating) -25°C to +70°C (non-operating)
Waterproofing standard	IPX6 and CFR46
<b>KEY FEATURES</b>	
Format	NTSC (xxx x xxx pixels) for USA and Canada PAL (752x582 pixels) for Europe and ROW
Imager	1/3 Sony Super HAD CCD (Super Hi Resolution)
Horizontal resolution	550 TVL
Focal length	4.3mm
Viewing angle	63° horizontal, 47° vertical, 78° diagonal
Minimum illumination	0.1Lux at F2.0 (no IR), 0 Lux (with IR)

## Ordering Information

PART #	DESCRIPTION
E03005	CAM100 (NTSC) Camera for USA and Canada
E32042	CAM100 (PAL) Camera for Europe and ROW
E32042	5m camera extension cable
E32042	15m camera extension cable

For complete CAM100 specifications please visit us online at [www.raymarine.com](http://www.raymarine.com).

## Dimensions

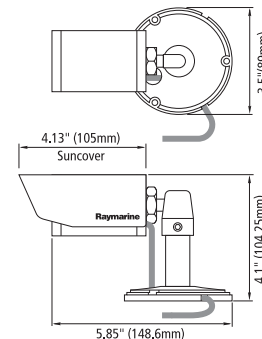

## Alphanumeric Navigation Keypad

Compatible with C-Series and E-Series Multifunction displays, the Alphanumeric Navigation Keypad makes entering and editing waypoint data, route names and text a snap. The keypad can be low-profile flush mounted to match your multifunction display, or in a convenient surface-mount configuration that matches instruments and autopilots.



### Features include:

- Seamless integration with C or E-Series displays using SeaTalk networking
- Alphanumeric and directional keys for easy data entry and menu scrolling
- Surface mount and low-profile mounting kits included

## Ordering Information

PART #	DESCRIPTION
E05008	Alphanumeric Navigation Keypad

## SeaTalk2 Full Function Remote Keyboard (E-Series Only)

Control your E-Series Multifunction Navigation system from anywhere with the Full Function Remote Keyboard. Connecting to the SeaTalk2 navigation network, the keyboard allows you complete control of your E-Series system. Combine the keyboard with a Raymarine Marine Monitor, big-screen TV, or other compatible video display and you can see and control the system from anywhere. The keyboard includes a flush-mountable dock that allows you to install the keyboard in your dash, console or bulkhead, yet easily remove it for handheld use.



### Features include:

- Convenient SeaTalk2 integration to the E80 or E120 display unit
- Integrated softkeys, Twist 'n Click control, function keys and alphanumeric keypad
- Flush-mount docking cradle included. Optional trunion mount and black bezel kit available
- Rugged, waterproof construction designed for above or below-decks mounting

## Ordering Information

PART #	DESCRIPTION
E55061	SeaTalk2 Full Function Remote Keyboard
E05010	Keyboard Black Bezel Kit
E05012	Keyboard Trunion Mounting Kit

## Smart Heading System

For installations without an onboard autopilot system or existing fast digital compass, the Raymarine Smart Heading system provides accurate high-speed (10 Hz) heading information to your C-Series or E-Series display for proper MARPA and radar-chart overlay operation.



### Features include:

- Integrated rate-gyro processor and external fluxgate compass
- Easy setup and calibration from your multifunction display
- SeaTalk and NMEA 0183 outputs
- Splash proof construction intended for installation in a sheltered location

## Ordering Information

PART #	DESCRIPTION
E12102	Smart Heading System

## SR100 Sirius Satellite Radio Weather Service Receiver (E-Series Only)

E-Series multifunction navigation displays now have the ability to graphically display up-to-date animated weather forecasts from Sirius Satellite Radio's new Marine Weather Service. Using the new Raymarine SR100 satellite weather receiver module, Raymarine E-Series displays deliver state-of-the-art forecast information including NOWRad® weather radar, storm tracks, sea surface temperature, wind, surface pressure, wave heights, lightning and much more. A monthly Sirius Marine Weather subscription is required to receive forecast on board.



### Features include:

- Simple SeaTalk™ connection to E-Series Multifunction Displays
- SRA40 Sirius marine antenna with 25 foot cable and mount included

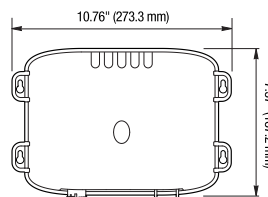

## Ordering Information

PART #	DESCRIPTION
E03008	SR100 – Sirius Weather Receiver System

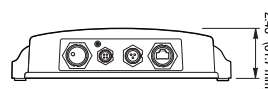

Configure your C or E-Series system online at [www.raymarine.com](http://www.raymarine.com).

# Sensor and Accessory Guide

## SeaTalk<sup>hs</sup> Networking Components: (E-Series Only)

The backbone of any multi-station E-series system, SeaTalk<sup>hs</sup> network cables, switches and couplers are engineered for the marine environment.



### Ordering Information

PART #	DESCRIPTION
E55060	SeaTalk <sup>hs</sup> Crossover Coupler
E55058	SeaTalk <sup>hs</sup> High-Speed Network Switch
E55049	SeaTalk <sup>hs</sup> Network Cable 1.5m

PART #	DESCRIPTION
E55050	SeaTalk <sup>hs</sup> Network Cable 5m
E55058	SeaTalk <sup>hs</sup> Network Cable 10m
E55052	SeaTalk <sup>hs</sup> Network Cable 20m

## NMEA 0183 and NMEA 2000 Interfacing:

Essential when using your C-Series or E-Series with features like AIS, NavTex, DSC Messaging, MARPA or radar-chart overlay, the NMEA Multiplexer allows you to connect up to 4 devices to the display's NMEA Input port. Use the C or E-Series' NMEA2000 connection to receive engine data from your NMEA2000 compatible electronic engine system.



### Ordering Information

PART #	DESCRIPTION
E55059	NMEA 0183 Multiplexer
E55059	NMEA 0183 Input/Output Cable 1.5m

PART #	DESCRIPTION
E55053	SeaTalk2-NMEA2000 Cable 1.5m

## E-Series Video Interfacing Cables:

E-Series' extensive video capabilities allow for video input from external cameras and entertainment devices, as well as video output to big screen TV's, PC monitors or marine monitors.



### Ordering Information

PART #	DESCRIPTION
E55057	Composite Video Input x4 Cable 1.5m
E55062	S-Video input x2 Cable 1.5m

PART #	DESCRIPTION
E55055	VGA Video Out Cable 10m
E55056	VGA Video Out Cable 20m

## SeaTalk Interface Cables and Accessories

Used to connect C or E-Series displays to instruments and autopilot systems like ST40, ST60, ST4000, SmartPilot autopilot systems and more.



### Ordering Information

PART #	DESCRIPTION
E55054	E-Series SeaTalk and Alarm Cable 1.5m
E26033	External Auxiliary Alarm Module
D284	SeaTalk Interconnect Cable 1m
D285	SeaTalk Interconnect Cable 3m
D286	SeaTalk Interconnect Cable 5m

PART #	DESCRIPTION
D287	SeaTalk Interconnect Cable 9m
D288	SeaTalk Interconnect Cable 20m
D244	SeaTalk 3-way junction block
E25049	SeaTalk/SeaTalk2 5-way junction block

Product specifications subject to change without notice.  
All registered marks and trademarks are property of their respected owners.

### Raymarine Incorporated

21 Manchester Street,  
Merrimack, New Hampshire 03054, USA  
Tel: 603.881.5200  
Fax: 603.864.4756  
www.raymarine.com

### Raymarine Plc

Quay Point, Northharbour Road,  
Portsmouth, Hampshire PO6 3TD, England  
Tel: +44 (0)23 9269 3611  
Fax: +44 (0)23 9269 4642  
www.raymarine.com

# Raymarine®

Raymarine, the world leader in marine electronics, is dedicated to the design and manufacture of the most comprehensive range of electronic equipment for the recreational boating and light commercial marine markets. Designed for high performance and ease of use, our award-winning products are available through our global network of dealers and distributors.